

**TITAN PASSIVE DATA SHEETS**

**MODEL:**

**TITAN-X12** ..... 1

**TITAN-X15** ..... 2

**TITAN 12Z** ..... 3

**TITAN 15Z** ..... 4

**TITAN 8** ..... 5

**TITAN 12** ..... 6

**TITAN 15** ..... 7



MODEL : TITAN-X12

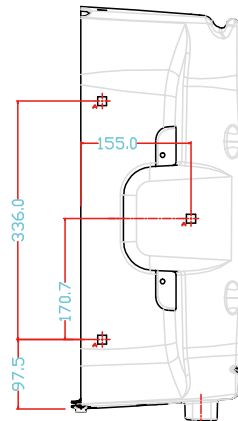
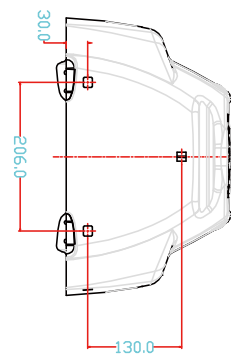
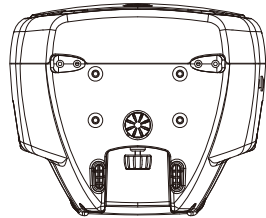
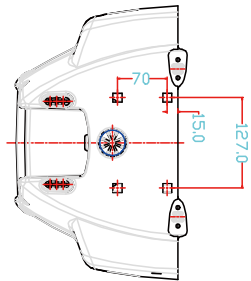
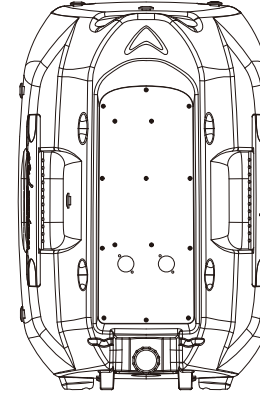
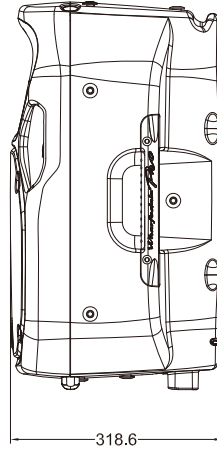
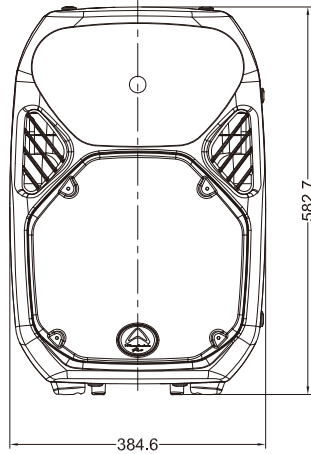
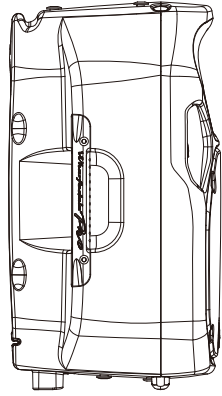
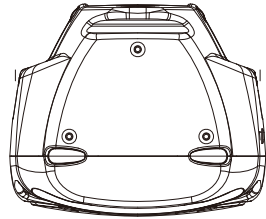

System Type	Passive
Configuration	12" 2-way
Frequency Response (+/-3dB)	55Hz-20kHz
Frequency Range (-10 dB)	50Hz-20kHz
Sensitivity (2.83v/1m)	98dB
Calculated Maximum SPL @1m	128dB
System Rated Impedance	8Ω
<b>Low Frequency Transducer</b>	
Size	305mm / 12"
Voice Coil Size	64.26mm / 2.5"
Rated Impedance	8Ω
LF Power (re:AES2-2012)	250w
<b>High Frequency Transducer</b>	
HF Driver Type	Compression Driver
Voice Coil Size	44mm / 1.75"
Exit Size	25mm / 1"
Diaphragm Material	Titanium
Rated Impedance	8Ω
HF Power (re:AES2-2012)	40w
Nominal Coverage (H x V)	Hybrid Symmetry Horn 100°x80°
<b>Power</b>	
System Continuous Power	250w
System Programme Power	500w
System Peak Power	1000w
Crossover frequency	2.6kHz
Input Connector	2 x NL4 (speakON compatible)
<b>Hardware</b>	
Pole Mount	35mm with lock screw
Handles	2 on sides
Rigging points	M8 * 10
<b>Enclosure</b>	
Enclosure Material	Trapezoidal / Polypropylene
Finish	Black / white
<b>Grille Material &amp; Finish</b>	
Dimensions - Unpacked	
Height	582.7mm / 22.9"
Width Front	384.6mm / 15.1"
Width Rear	384.6mm / 15.1"
Depth	318.6mm / 12.5"
<b>Dimensions - Packed</b>	
Height	663mm / 26.1"
Width Front	435mm / 17.1"
Width Rear	435mm / 17.1"
Depth	408mm / 16.1"
Weight	
Net Weight (kg / lbs)	12.0kg / 26.4lbs
Gross Weight (kg / lbs)	15.1kg / 33.2lbs

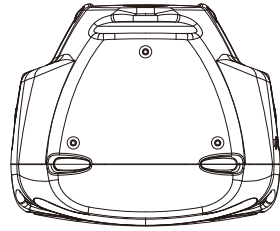

MODEL : **TITAN-X15**

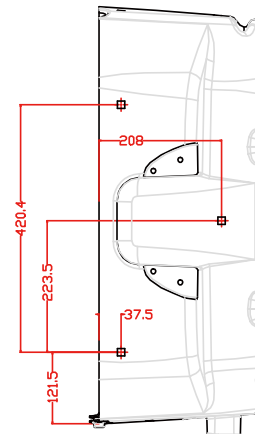
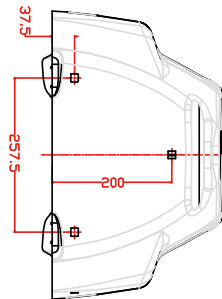
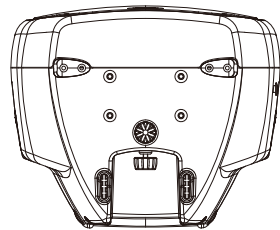
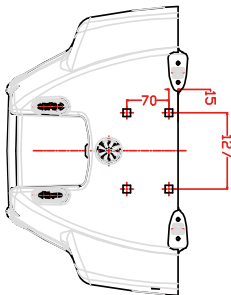
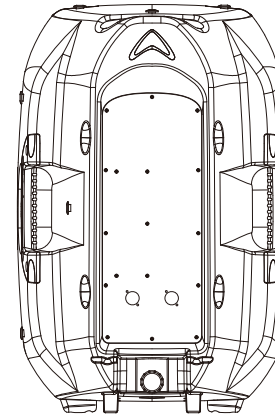
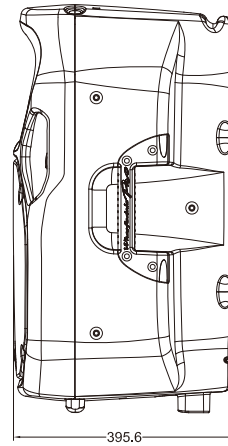
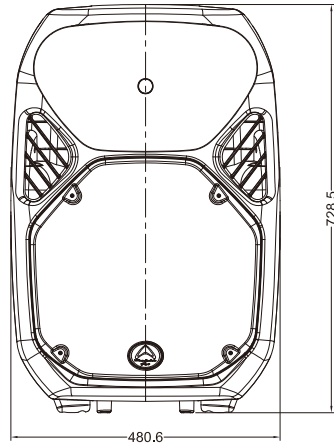
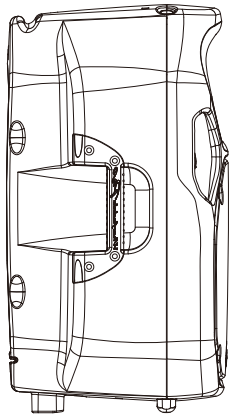

System Type	Passive
Configuration	15" 2-way
Frequency Response (+/-3dB)	50Hz-20kHz
Frequency Range (-10 dB)	40Hz-20kHz
Sensitivity (2.83v/1m)	97dB
Calculated Maximum SPL @1m	129dB
System Rated Impedance	8Ω
<b>Low Frequency Transducer</b>	
Size	381mm / 15"
Voice Coil Size	75mm / 3.0"
Rated Impedance	8Ω
LF Power (re:AES2-2012)	400w
<b>High Frequency Transducer</b>	
HF Driver Type	Compression Driver
Voice Coil Size	44mm / 1.75"
Exit Size	25mm / 1"
Diaphragm Material	Titanium
Rated Impedance	8Ω
HF Power (re:AES2-2012)	40w
Nominal Coverage (H x V)	Hybrid Symmetry Horn 100°x80°
<b>Power</b>	
System Continuous Power	400w
System Programme Power	800w
System Peak Power	1600w
Crossover frequency	2.7kHz
Input Connector	2 x NL4 (speakON compatible)
<b>Hardware</b>	
Pole Mount	35mm with lock screw
Handles	2 on sides
Rigging points	M8 * 10
<b>Enclosure</b>	
Enclosure Material	Trapezoidal / Polypropylene
Finish	Black / white
<b>Grille Material &amp; Finish</b>	
Dimensions - Unpacked	
Height	728.5mm / 28.7"
Width Front	480.6mm / 18.9"
Width Rear	480.6mm / 18.9"
Depth	395.6mm / 15.6"
<b>Dimensions - Packed</b>	
Height	830mm / 32.7"
Width Front	514mm / 20.2"
Width Rear	514mm / 20.2"
Depth	489mm / 19.3"
Weight	
Net Weight (kg / lbs)	22.0kg / 48.4lbs
Gross Weight (kg / lbs)	26.8kg / 59.0lbs



MODEL : TITAN 12Z

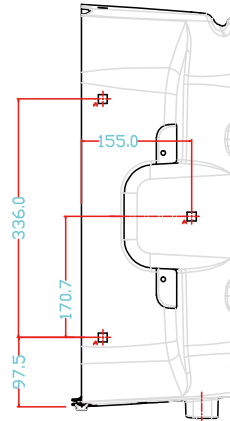
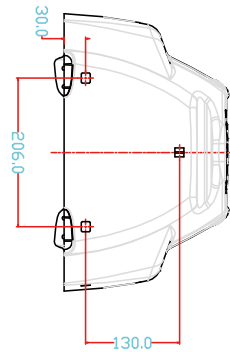
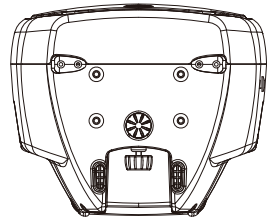
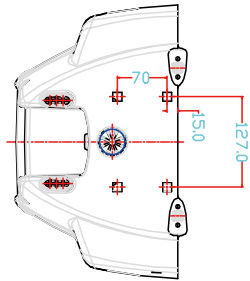
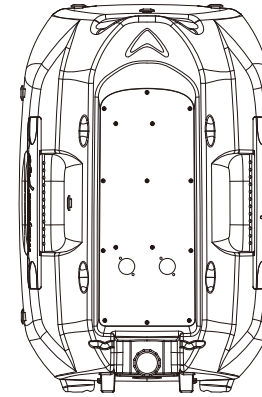
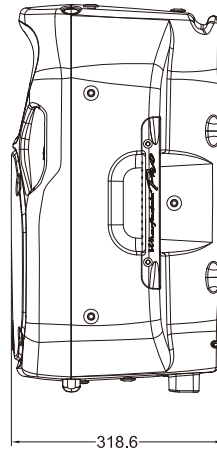
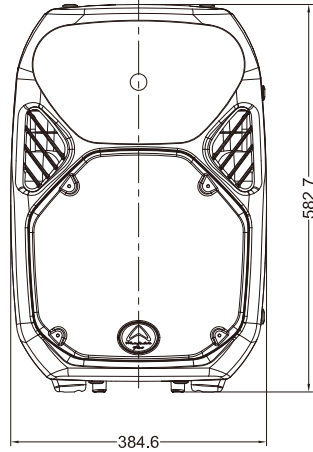
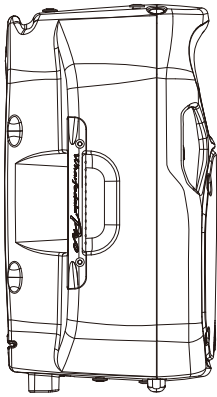
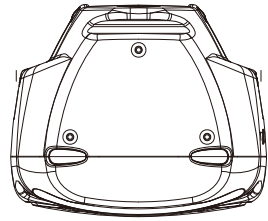

System Type	Passive
Configuration	12" 2-way
Frequency Response (+/-3dB)	55Hz-20kHz
Frequency Range (-10 dB)	50Hz-20kHz
Sensitivity (2.83v/1m)	99dB
Calculated Maximum SPL @1m	132dB
System Rated Impedance	8Ω
<b>Low Frequency Transducer</b>	
Size	305mm / 12"
Voice Coil Size	75mm / 3.0"
Rated Impedance	8Ω
LF Power (re:AES2-2012)	500w
<b>High Frequency Transducer</b>	
HF Driver Type	Compression Driver
Voice Coil Size	44mm / 1.75"
Exit Size	25mm / 1"
Diaphragm Material	Titanium
Rated Impedance	8Ω
HF Power (re:AES2-2012)	40W
Nominal Coverage (H x V)	Hybrid Symmetry Horn 100°x80°
<b>Power</b>	
System Continuous Power	500w
System Programme Power	1000w
System Peak Power	2000w
Crossover frequency	2.1kHz
Input Connector	2 x NL4 (speakON compatible)
<b>Hardware</b>	
Pole Mount	35mm with lock screw
Handles	2 on sides
Rigging points	M8 * 10
<b>Enclosure</b>	
Enclosure Material	Trapezoidal / Polypropylene
Finish	Black / white
<b>Grille Material &amp; Finish</b>	
Dimensions - Unpacked	
Height	582.7mm / 22.9"
Width Front	384.6mm / 15.1"
Width Rear	384.6mm / 15.1"
Depth	318.6mm / 12.5"
<b>Dimensions - Packed</b>	
Height	663mm / 26.1"
Width Front	435mm / 17.1"
Width Rear	435mm / 17.1"
Depth	408mm / 16.1"
Weight	
Net Weight (kg / lbs)	15.7kg / 34.5lbs
Gross Weight (kg / lbs)	18.8kg/41.2lbs

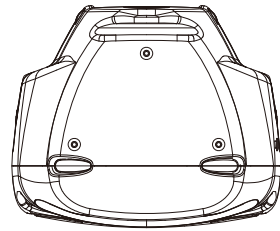

MODEL : TITAN 15Z

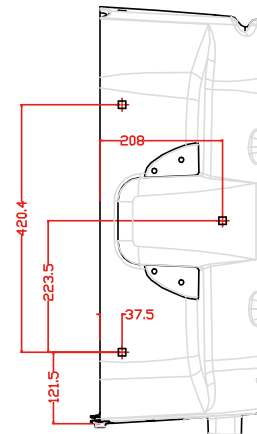
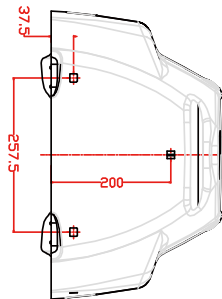
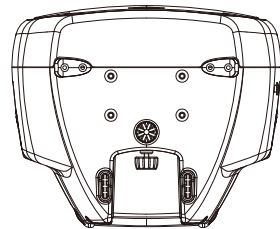
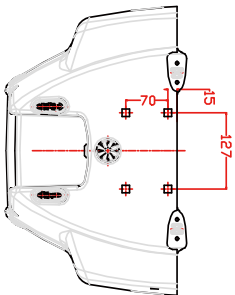
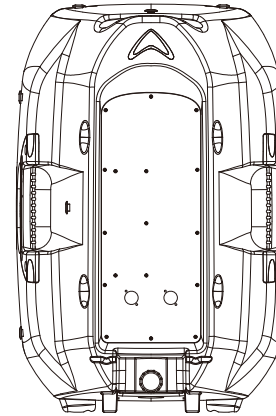
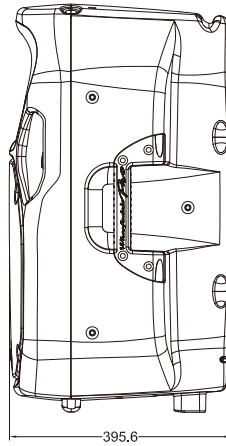
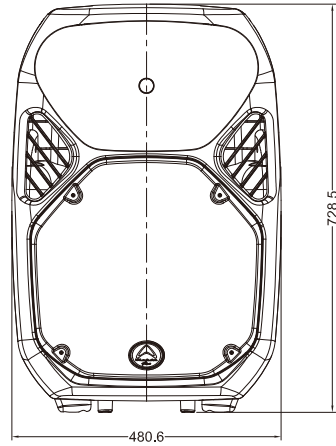
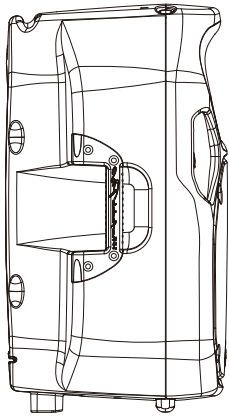

System Type	Passive
Configuration	15" 2-way
Frequency Response (+/-3dB)	45Hz-20kHz
Frequency Range (-10 dB)	40Hz-20kHz
Sensitivity (2.83v/1m)	99dB
Calculated Maximum SPL @1m	133.5dB
System Rated Impedance	8Ω
<b>Low Frequency Transducer</b>	
Size	381mm / 15"
Voice Coil Size	100mm / 4.0"
Rated Impedance	8Ω
LF Power (re:AES2-2012)	700w
<b>High Frequency Transducer</b>	
HF Driver Type	Compression Driver
Voice Coil Size	50mm / 2.0"
Exit Size	25mm / 1"
Diaphragm Material	Titanium
Rated Impedance	8Ω
HF Power (re:AES2-2012)	50W
Nominal Coverage (H x V)	Hybrid Symmetry Horn 100°x80°
<b>Power</b>	
System Continuous Power	700W
System Programme Power	1400W
System Peak Power	2800W
Crossover frequency	2.1kHz
Input Connector	2 x NL4 (speakON compatible)
<b>Hardware</b>	
Pole Mount	35mm with lock screw
Handles	2 on sides
Rigging points	M8 * 10
<b>Enclosure</b>	
Enclosure Material	Trapezoidal / Polypropylene
Finish	Black / white
<b>Grille Material &amp; Finish</b>	
Dimensions - Unpacked	
Height	728.5mm / 28.7"
Width Front	480.6mm / 18.9"
Width Rear	480.6mm / 18.9"
Depth	395.6mm / 15.6"
<b>Dimensions - Packed</b>	
Height	830mm / 32.7"
Width Front	514mm / 20.2"
Width Rear	514mm / 20.2"
Depth	489mm / 19.3"
Weight	
Net Weight (kg / lbs)	25.8kg / 56.8lbs
Gross Weight (kg / lbs)	30.6kg / 67.3lbs



MODEL : TITAN 8

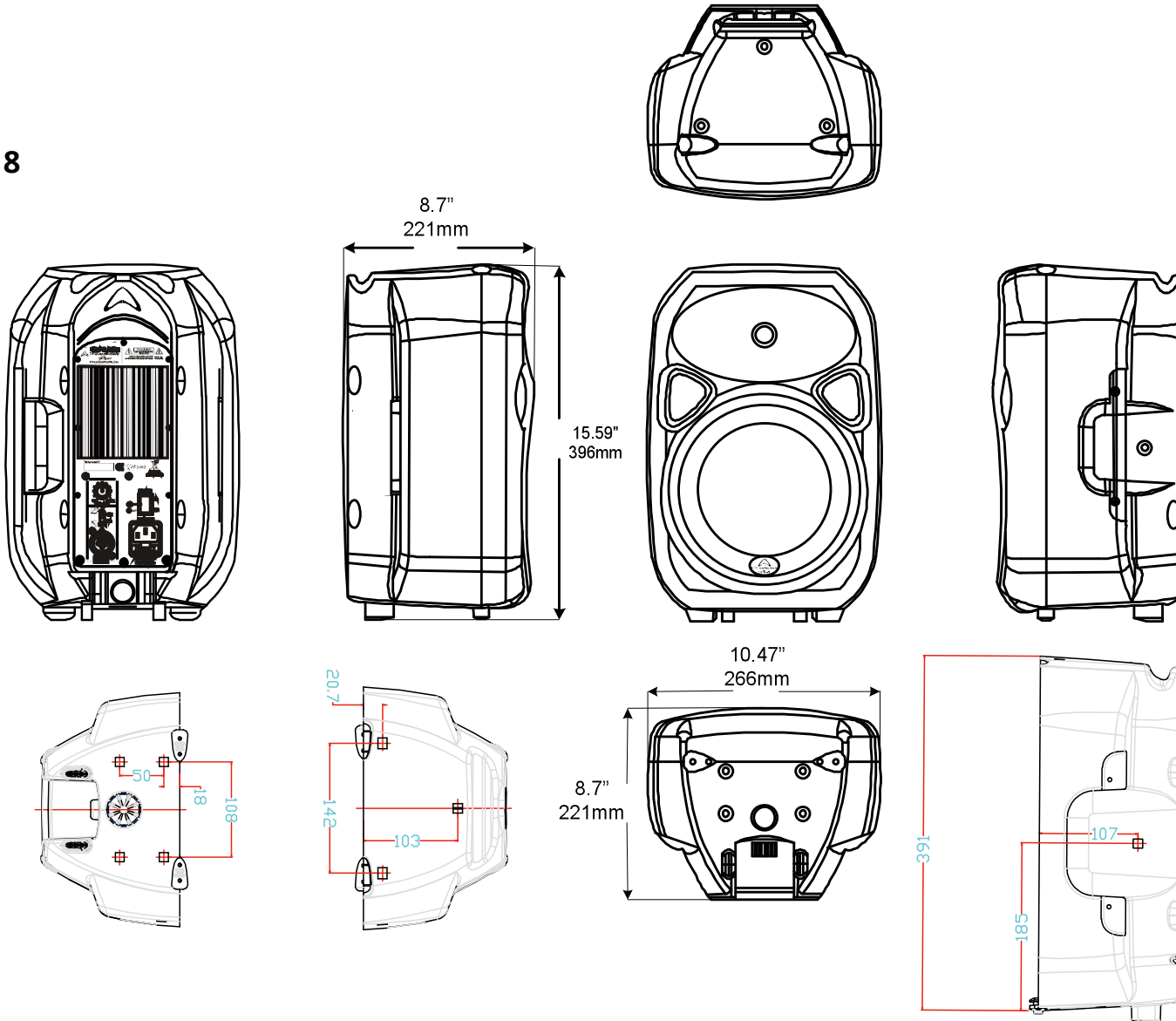

System Type	Passive
Configuration	8" 2-way
Frequency Response (+/-3dB)	70 - 20kHz
Frequency Range (-10 dB)	65 - 20kHz
Sensitivity (2.83v/1m)	96dB
Calculated Maximum SPL @1m	124dB
System Rated Impedance	8Ω
<b>Low Frequency Transducer</b>	
Size	203mm / 8"
Voice Coil Size	38.86mm / 1.53"
Rated Impedance	8Ω
LF Power (re:AES2-2012)	150w
<b>High Frequency Transducer</b>	
HF Driver Type	Compression Driver
Voice Coil Size	25mm / 1"
Exit Size	30mm / 1.2"
Diaphragm Material	Mylar
Rated Impedance	8Ω
HF Power (re:AES2-2012)	20w
Nominal Coverage (H x V)	Elliptical waveguide 90° x 60°
<b>Power</b>	
System Continuous Power	150w
System Programme Power	300w
System Peak Power	600w
Crossover frequency	2-way 2.4kHz / Linkwitz-Riley
Input Connector	2 x NL4 (speakON compatible) / 2 x 1/4"
<b>Hardware</b>	
Pole Mount	35mm with lock screw
Handles	1 on side
Rigging points	M6 * 8
<b>Enclosure</b>	
Enclosure Material	Trapezoidal / Polypropylene
Finish	Grey, Black, White
<b>Grille Material &amp; Finish</b>	
Dimensions - Unpacked	
Height	396mm / 15.59"
Width Front	266mm / 10.47"
Width Rear	266mm / 10.47"
Depth	221mm / 8.7"
<b>Dimensions - Packed</b>	
Height	463mm / 18.2"
Width Front	325mm / 12.8"
Width Rear	325mm / 12.8"
Depth	282mm / 11.1"
Weight	
Net Weight (kg / lbs)	5.5kg / 12.1 lbs
Gross Weight (kg / lbs)	7.5kg / 16.5 lbs



MODEL : TITAN 12

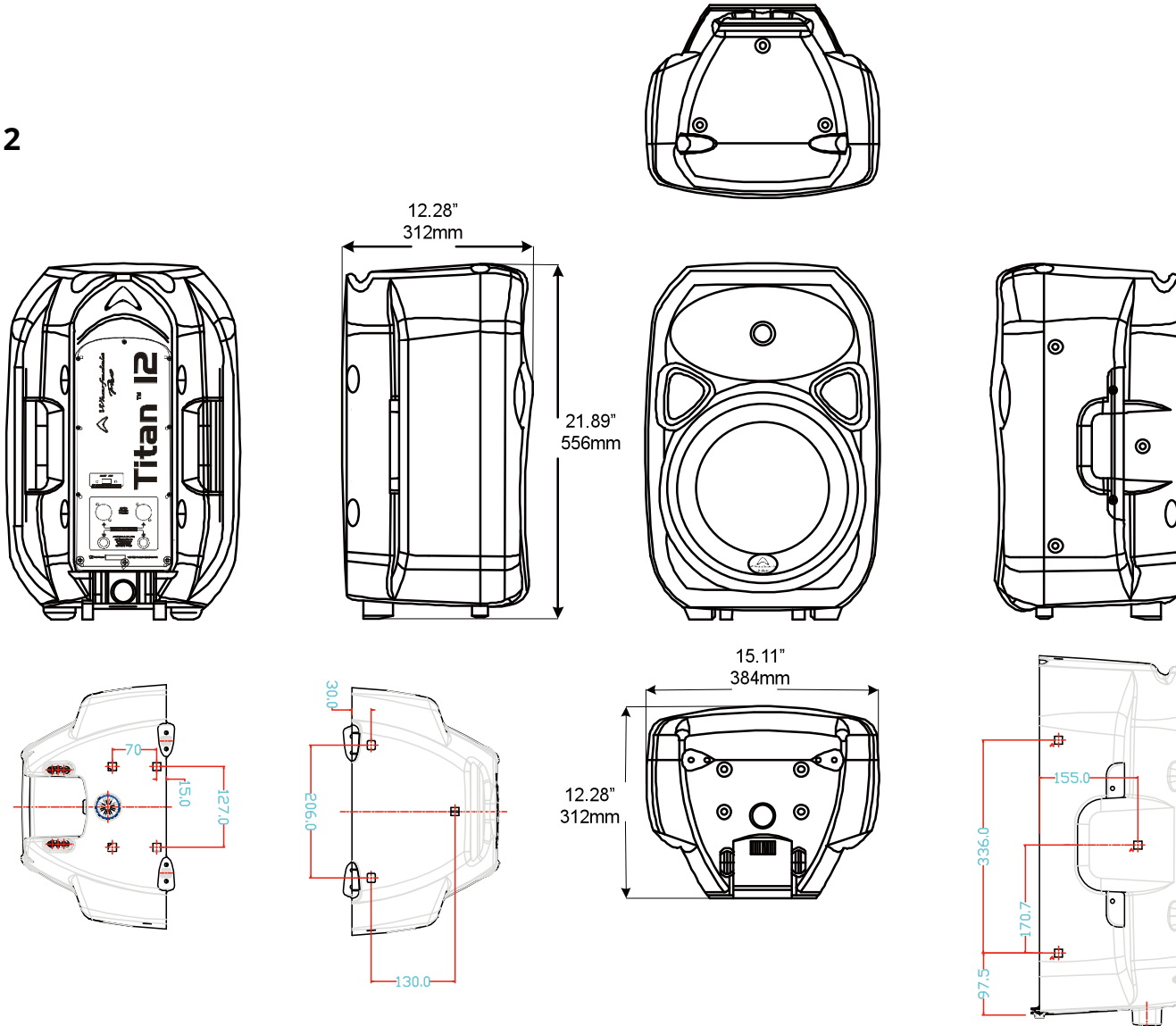

System Type	Passive
Configuration	12" 2-way
Frequency Response (+/-3dB)	55Hz-20kHz
Frequency Range (-10 dB)	50Hz-20kHz
Sensitivity (2.83v/1m)	98dB
Calculated Maximum SPL @1m	128dB
System Rated Impedance	8Ω
<b>Low Frequency Transducer</b>	
Size	305mm / 12"
Voice Coil Size	64.26mm / 2.5"
Rated Impedance	8Ω
LF Power (re:AES2-2012)	250w
<b>High Frequency Transducer</b>	
HF Driver Type	Compression Driver
Voice Coil Size	44mm / 1.75"
Exit Size	25mm / 1"
Diaphragm Material	Titanium
Rated Impedance	8Ω
HF Power (re:AES2-2012)	40w
Nominal Coverage (H x V)	Elliptical waveguide 90° x 60°
<b>Power</b>	
System Continuous Power	250w
System Programme Power	500w
System Peak Power	1000w
Crossover frequency	2-way 2.2kHz / Linkwitz-Riley
Input Connector	2 x NL4 (speakON compatible) / 2 x 1/4"
<b>Hardware</b>	
Pole Mount	35mm with lock screw
Handles	2 on sides
Rigging points	M8 * 10
<b>Enclosure</b>	
Enclosure Material	Trapezoidal / Polypropylene
Finish	Grey, Black, White
<b>Grille Material &amp; Finish</b>	
Dimensions - Unpacked	
Height	556mm / 21.88"
Width Front	384.6mm / 15.1"
Width Rear	384.6mm / 15.1"
Depth	312mm / 12.3"
<b>Dimensions - Packed</b>	
Height	663mm / 26.1"
Width Front	435mm / 17.1"
Width Rear	435mm / 17.1"
Depth	408mm / 16.1"
Weight	
Net Weight (kg / lbs)	12.0kg / 26.4lbs
Gross Weight (kg / lbs)	15.1kg / 33.2lbs





MODEL : TITAN 15

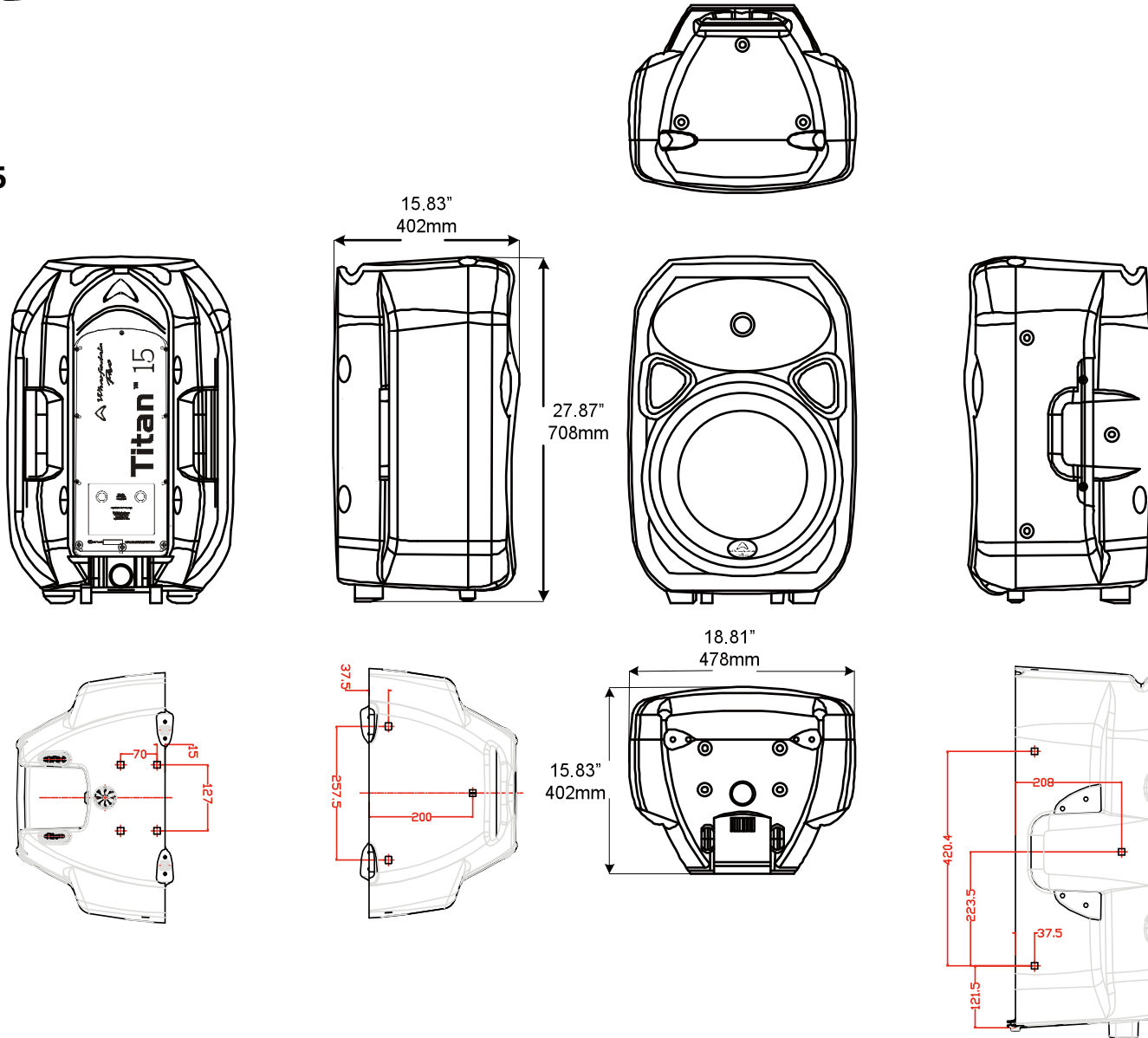

System Type	Passive
Configuration	15" 2-way
Frequency Response (+/-3dB)	50Hz-20kHz
Frequency Range (-10 dB)	40Hz-20kHz
Sensitivity (2.83v/1m)	97dB
Calculated Maximum SPL @1m	129dB
System Rated Impedance	8Ω
<b>Low Frequency Transducer</b>	
Size	381mm / 15"
Voice Coil Size	75mm / 3.0"
Rated Impedance	8Ω
LF Power (re:AES2-2012)	400w
<b>High Frequency Transducer</b>	
HF Driver Type	Compression Driver
Voice Coil Size	51mm / 2.0"
Exit Size	25mm / 1"
Diaphragm Material	Titanium
Rated Impedance	8Ω
HF Power (re:AES2-2012)	40w
Nominal Coverage (H x V)	Elliptical waveguide 90° x 60°
<b>Power</b>	
System Continuous Power	400w
System Programme Power	800w
System Peak Power	1600w
Crossover frequency	2-way 1.8kHz / Linkwitz-Riley
Input Connector	2 x NL4 (speakON compatible) / 2 x 1/4"
<b>Hardware</b>	
Pole Mount	35mm with lock screw
Handles	2 on sides
Rigging points	M8 * 10
<b>Enclosure</b>	
Enclosure Material	Trapezoidal / Polypropylene
Finish	Grey, Black, White
<b>Grille Material &amp; Finish</b>	
1.2 steel	
<b>Dimensions - Unpacked</b>	
Height	708.3mm / 27.9"
Width Front	477.8mm / 18.8"
Width Rear	477.8mm / 18.8"
Depth	401.77mm / 15.8"
<b>Dimensions - Packed</b>	
Height	830mm / 32.7"
Width Front	514mm / 20.2"
Width Rear	514mm / 20.2"
Depth	489mm / 19.3"
<b>Weight</b>	
Net Weight (kg / lbs)	22.0kg / 48.4lbs
Gross Weight (kg / lbs)	26.8kg / 59.0lbs

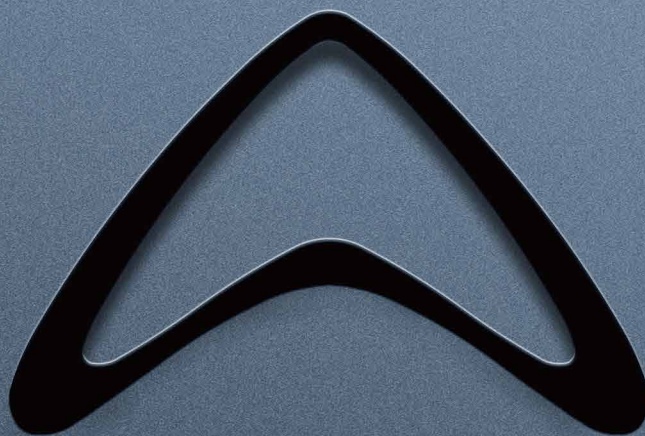

**[WWW.WHARFEDALEPRO.COM](http://WWW.WHARFEDALEPRO.COM)**

IAG HOUSE, 13/14 GLEBE ROAD, HUNTINGDON, CAMBRIDGESHIRE,  
PE29 7DL, UK  
TEL: +44(0) 1480 452 561