

Portable Speakers

iQ10

2500 Watt 2 Way
10" Powered Loudspeaker with
KLARK TEKNIK DSP Technology,
Speaker Modelling and
ULTRANET Networking

- 2 way full range loudspeaker for portable PA and installation applications
- 2,500 Watt power featuring KLARK TEKNIK Class-D technology
- KLARK TEKNIK Digital Signal Processing for total system control
- Speaker modelling includes accurate models of industry standard speakers
- SCC (Spatial Contour Control) compensates frequency response in relation to physical speaker placement
- ULTRANET digital audio networking connects to mixers and other sources
- 10" low frequency driver with low mass voice coil for improved transient response
- High temperature 1" compression driver with copper-clad aluminium voice coil for extended high frequency reproduction
- Fully featured user interface with LCD display for ease of navigation
- PC remote control software downloadable at turbosound.com
- Lightweight fibre glass reinforced composite enclosure
- Rugged powder coated perforated steel mesh grille
- Dual angle pole mount for accurate audience coverage

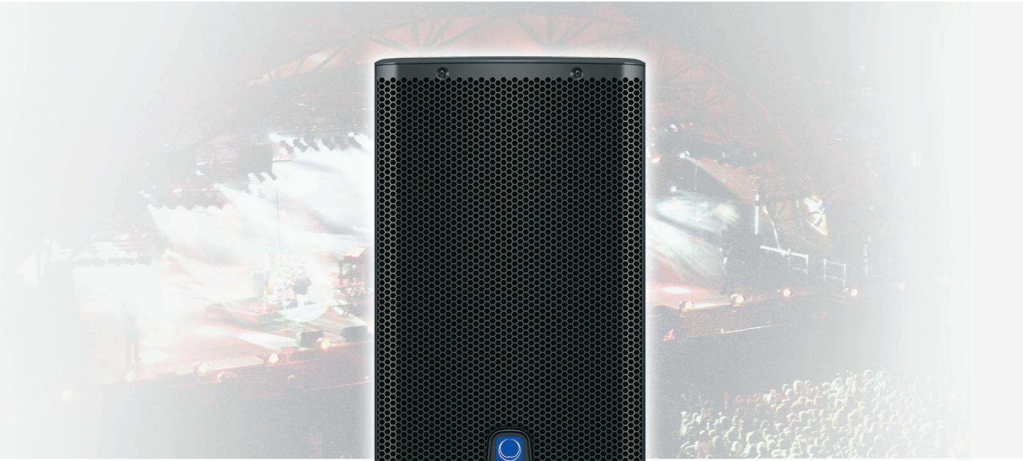

The 2,500-Watt iQ10 is a powered two-way loudspeaker ideally suited for a wide range of portable and fixed installation, music and speech sound reinforcement applications. The driver complement includes an 10" low frequency driver with a low mass voice coil for improved transient response, and a high temperature 1" compression driver with copper-clad aluminium voice coil for extended high frequency reproduction.



Equipped with a very efficient and lightweight two channel KLARK TEKNIK Class-D power amplifier, the iQ10 provides an impressive 2,500 Watts of output power. A high degree of control over the loudspeaker system's performance is managed by a sophisticated, but easy to use KLARK TEKNIK Digital Signal Processor (DSP), which provides dynamic EQ for remarkable full range response at low volume levels, and transparent limiting for the utmost clarity at high output levels – and long-term reliability. iQ10's advanced DSP speaker modelling presets include detailed and accurate models of some of the audio industry's most-respected loudspeakers.

KLARK TEKNIK also developed a highly versatile Spatial Contour Control (SCC) DSP function, which allows the user to easily optimise the iQ10's frequency response for the physical speaker placement. This advanced functionality provides frequency compensation for stand, floor, wall or ceiling placement, much like the adjustments commonly found on studio reference monitors.

iQ10

2500 Watt 2 Way
10" Powered Loudspeaker with
KLARK TEKNIK DSP Technology,
Speaker Modelling and
ULTRANET Networking

- Multiple internal rigging points for installation applications
- Mains input and link output on Neutrik powerCON* connectors
- 10-Year Warranty Program*
- Designed and engineered in the U.K.

On the rear panel amplifier module, you will find a fully featured user interface consisting of an LCD display, the Channel A and B gain controls, and a single rotary encoder for intuitive access to level, EQ, Speaker modelling, SCC, Subwoofer Integration and Feedback Control (FBI). In addition to the two combination balanced XLR/jack inputs, balanced XLR outputs for each of the two independent channels, and a Mix Out XLR connector, the iQ10 features a mic/line switch and level control with signal present LED on each channel.

The iQ10 also features our proprietary ULTRANET technology, which allows the use of CAT5 cables for transmitting pristine multi-channel audio signals and other information between ULTRANET-enabled products, such as digital mixers and personal monitor systems. This digital distribution networking not only eliminates the potential for RFI and crosstalk so common to analogue methods, but also significantly reduces the setup or installation time required. An onboard USB port provides access for remote control of the iQ10 via PC computer, as well as DSP and speaker modelling firmware updates.

The lightweight fibre glass reinforced composite enclosure is fitted with a rugged powder coated perforated steel mesh grille and multiple internal rigging points for permanent installations. The iQ10 is also fitted with a dual angle pole mount socket, allowing the enclosure to be pole mounted straight on, or raised and angled downwards for optimal audience coverage. Mains power input and link output is provided via Neutrik powerCON* connectors.

*All third-party trademarks are the property of their respective owners. Their use neither constitutes a claim of the trademark nor affiliation of the trademark owners with MUSIC Group. Product names are mentioned solely as a reference for compatibility, effects and/or components. Warranty details can be found at music-group.com.

Portable Speakers

iQ10

2500 Watt 2 Way
10" Powered Loudspeaker with
KLARK TEKNIK DSP Technology,
Speaker Modelling and
ULTRANET Networking



You Are Covered

We always strive to provide the best possible Customer Experience. Our products are made in our own [MUSIC Tribe](#) factory using state-of-the-art automation, enhanced production workflows and quality assurance labs with the most sophisticated test equipment available in the world. As a result, we have one of the lowest product failure rates in the industry, and we confidently back it up with a generous [Warranty program](#).

Portable Speakers

iQ10

2500 Watt 2 Way
10" Powered Loudspeaker with
KLARK TEKNIK DSP Technology,
Speaker Modelling and
ULTRANET Networking

Frequency Response Sensitivity 1 W / 1 m

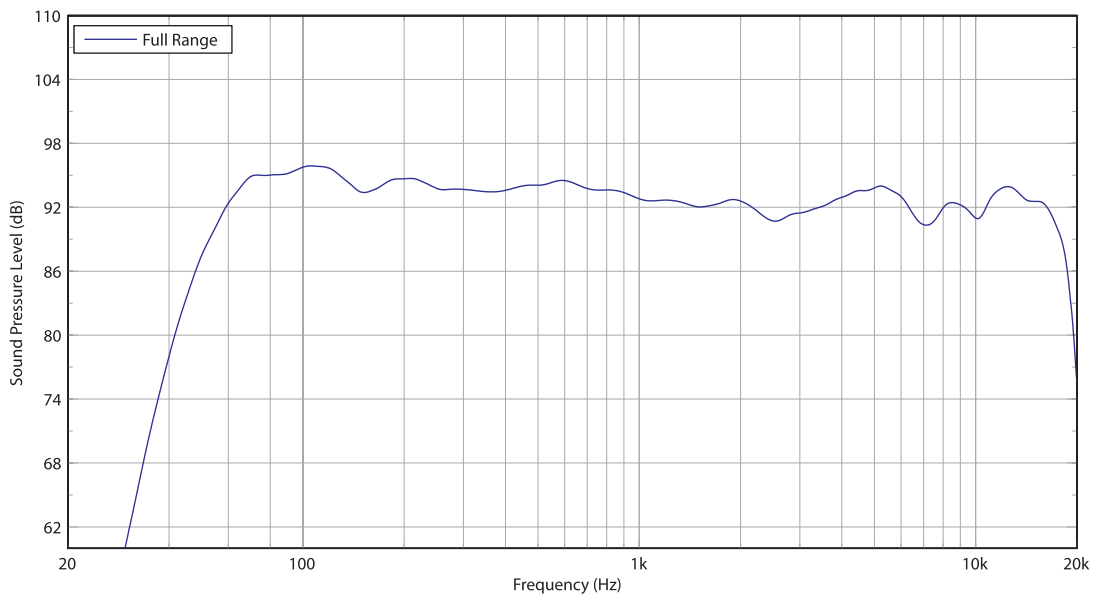

Portable Speakers

iQ10

2500 Watt 2 Way
10" Powered Loudspeaker with
KLARK TEKNIK DSP Technology,
Speaker Modelling and
ULTRANET Networking

Horizontal Beamwidth

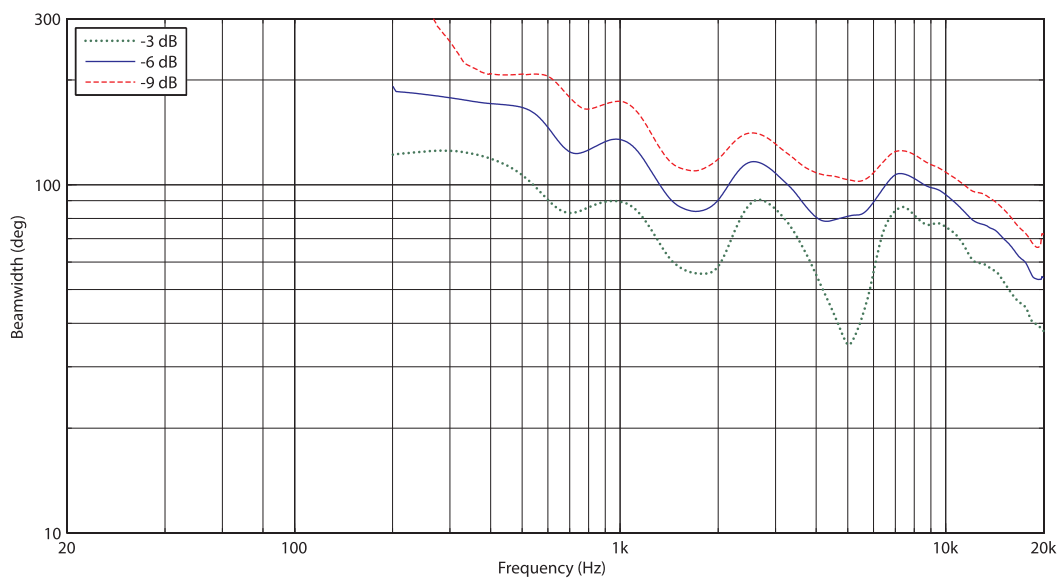

Vertical Beamwidth

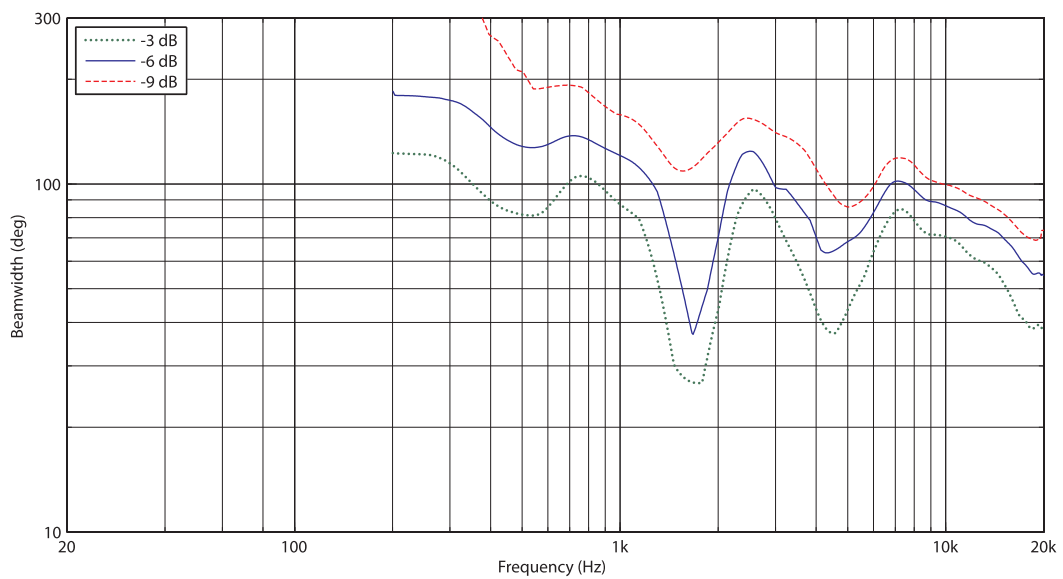

Portable Speakers

iQ10

2500 Watt 2 Way
10" Powered Loudspeaker with
KLARK TEKNIK DSP Technology,
Speaker Modelling and
ULTRANET Networking

Horizontal Polar Plots

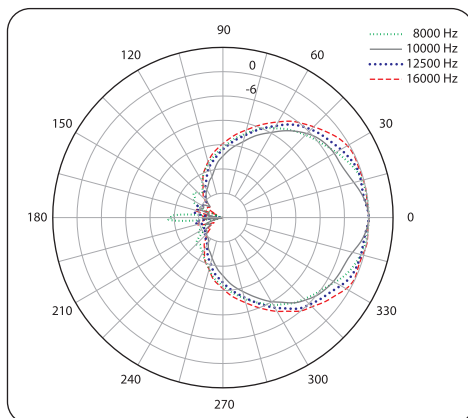
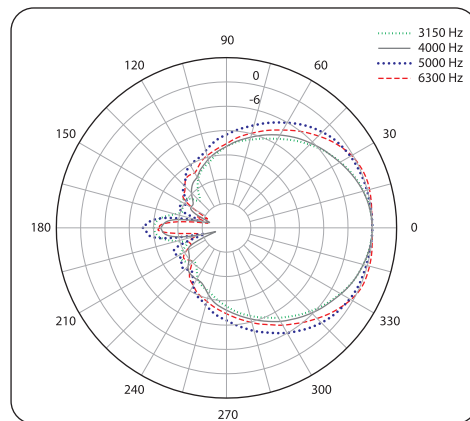
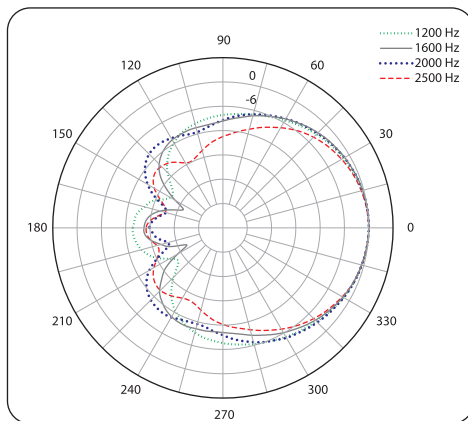
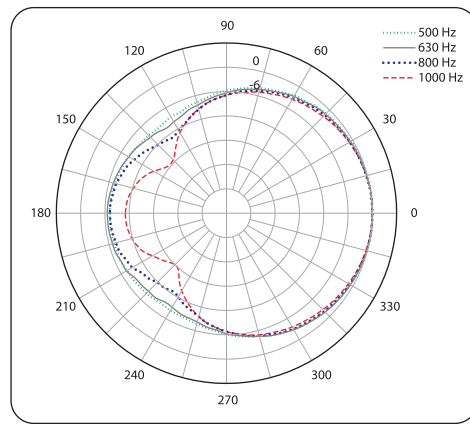
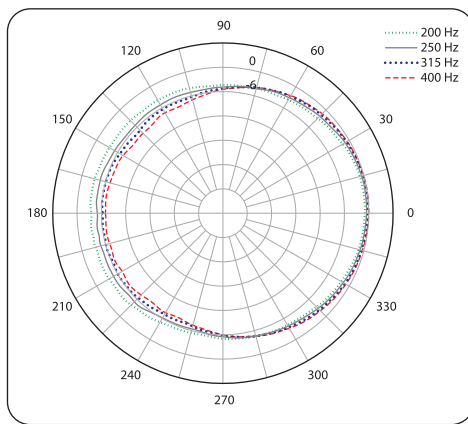

Portable Speakers

iQ10

2500 Watt 2 Way
10" Powered Loudspeaker with
KLARK TEKNIK DSP Technology,
Speaker Modelling and
ULTRANET Networking

Vertical Polar Plots

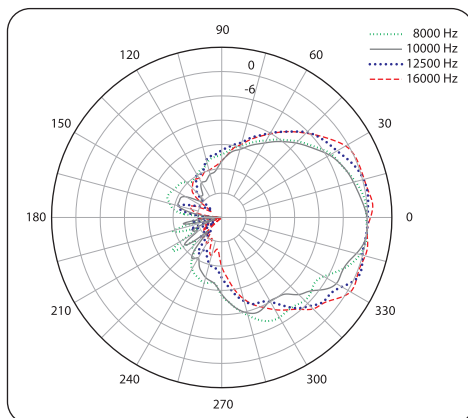
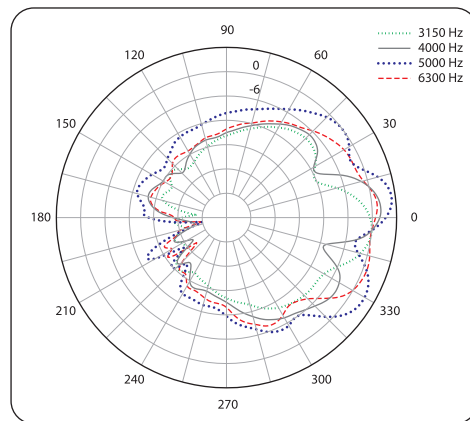
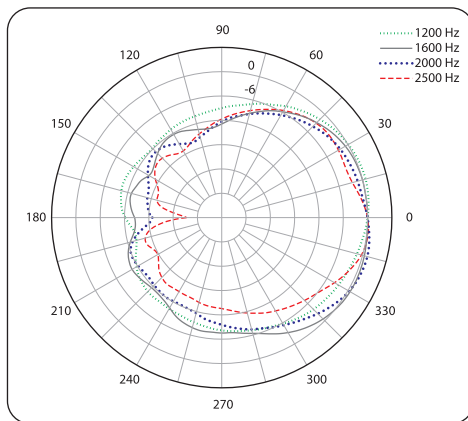
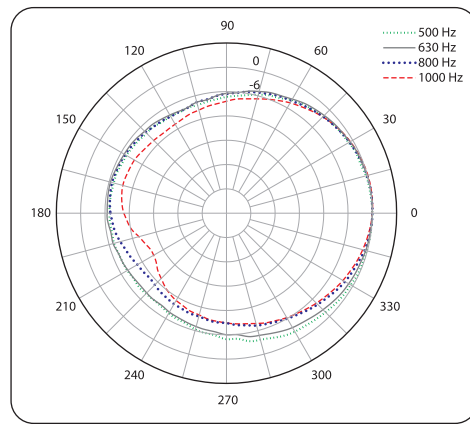
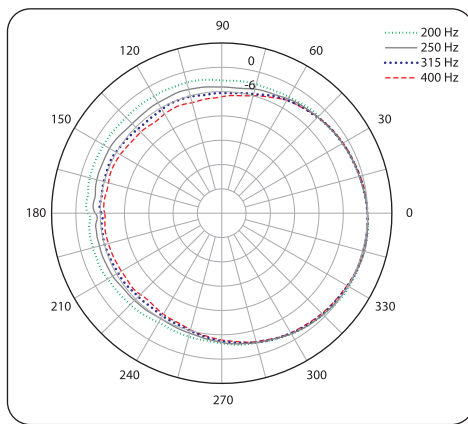

Portable Speakers

iQ10

2500 Watt 2 Way
10" Powered Loudspeaker with
KLARK TEKNIK DSP Technology,
Speaker Modelling and
ULTRANET Networking

Dimensions

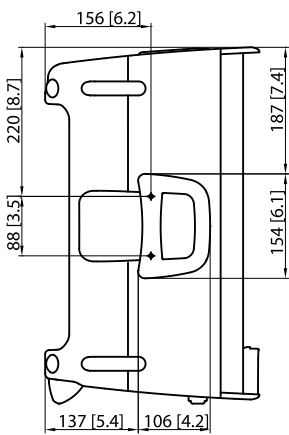
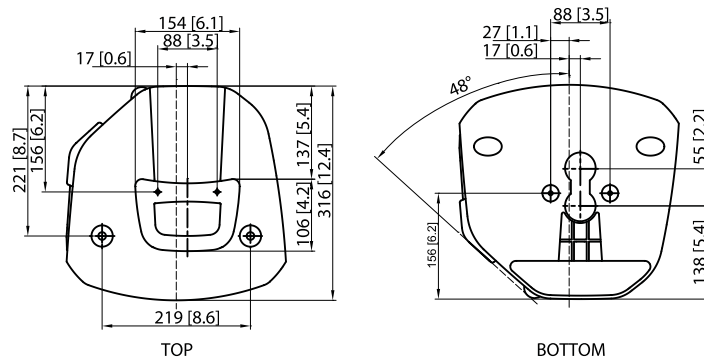

LEFT

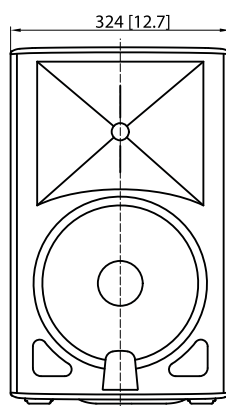

FRONT

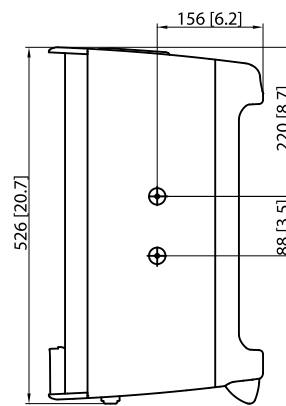

RIGHT

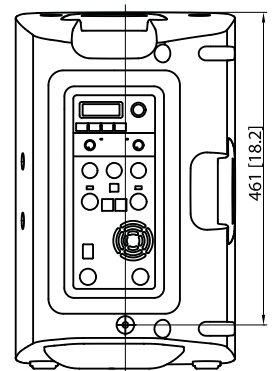

BACK

Portable Speakers

iQ10

2500 Watt 2 Way
10" Powered Loudspeaker with
KLARK TEKNIK DSP Technology,
Speaker Modelling and
ULTRANET Networking

Mounting and Rigging

The cabinet is fitted with M10 x 3 internally-threaded rigging points that allow it to be rigged with optional shoulder eyebolts in different configurations in permanent installations. The simplest method of rigging is to use the two M10 rigging points on the top, and a single pull-back rigging point on the rear panel. Adjustment of the length of the rear cable allows the cabinet to be angled for optimum room coverage.

The cabinet is fitted with a dual angle pole mount socket, allowing the enclosure to be pole mounted straight on, or raised and angled downwards for optimal audience coverage

The optional **iQ10-WB** wall bracket allows the cabinet to be surface mounted horizontally and vertically, and angled for optimum positioning and coverage.

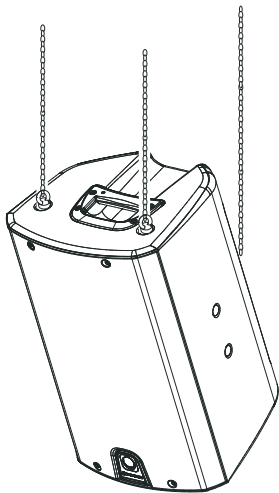

Suspension using M10 shoulder eyebolts.

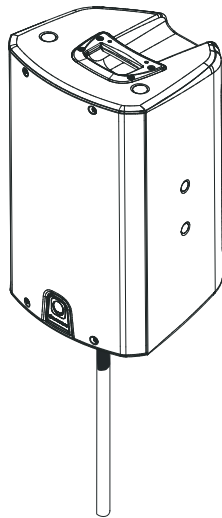

Mounting on 35 mm pole or speaker stand.

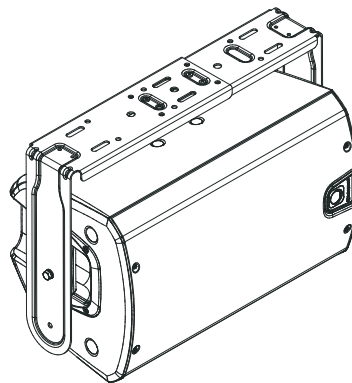

iQ10-WB wall bracket: horizontal mounting.

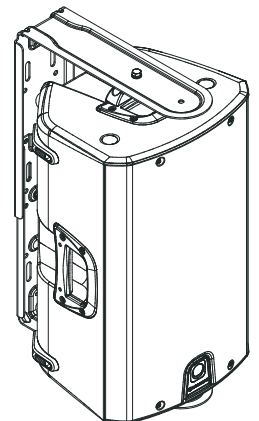

iQ10-WB wall bracket: vertical mounting.

Portable Speakers

iQ10

2500 Watt 2 Way
10" Powered Loudspeaker with
KLARK TEKNIK DSP Technology,
Speaker Modelling and
ULTRANET Networking

Technical Specifications

System

Frequency response	55 Hz – 18 kHz \pm 3 dB 50 Hz – 20 kHz -10 dB
Nominal dispersion	90° H x 60° V @ -6 dB points
Maximum SPL	129 dB peak
Crossover type	Active
Transducers	1 x 10" (256 mm) LF driver 1 x 1" (25.4 mm) HF compression driver
Limiter	Independent HF, LF, peak and rms

Amplifier

Maximum output power*	2,500 W
Type	Class-D
Protection	Short circuit, open circuit, thermal

Connectors

Input A / B	2 x combo jack/XLR
Sensitivity	Line +4 dBu, mic -22 dBu, switchable
Input impedance	20 k Ω unbalanced, 40 k Ω balanced
Maximum input level	+21 dBu
Output A / B	2 x XLR Linked to input
Mix output	XLR, balanced
Output impedance	100 Ω unbalanced, 200 Ω balanced
Ultranet input/link	2 x RJ45
Mains Supply	Neutrik powerCON input 20A and link 15A

Controls

DSP	Rotary push-encoder Buttons for PROCESS, SETUP, EXIT, ENTER
Mixer section	2 x gain controls (channels A and B) 2 x Line/Mic switch

User DSP Functions

Factory EQ presets	Positioning, Sound mode, Sound modeling, FBQ
Display	LCD 128 x 32, blue backlit
Delay	0 - 300 ms
Equalisation	High and low shelving EQ 2 x parametric EQ
Limiter	Zero attack input limiter
Presets	20 total presets, 19 user-definable
Crossover	High Pass L-R 24 dB/oct
Protection	Lock-out function for all settings

Ultranet Digital Network

System	
Signal	16 channels
Latency	< 0.9 ms
Cabling	
Cables	Shielded CAT5
Cable length	max. 246 ft / 75 m recommended

Power Supply

Power consumption	150 W @ 1/8 max power
Voltage (fuses)	
USA / Canada	120 V~, 60 Hz (T 15 A H 250 V)
UK / Australia / Europe	220-240 V~, 50/60 Hz (T 10 A H 250 V)
Korea / China	220-240 V~, 50/60 Hz (T 10 A H 250 V)
Japan	100 V~, 50/60 Hz (T 15 A H 250 V)

Enclosure

Dimensions H x W x D	526 x 324 x 316 mm (20.7 x 12.7 x 12.4")
Net weight	17.2 kg (38 lbs)
Construction	Injection-moulded polypropylene enclosure
Finish	Black painted
Grille	Powder coated perforated steel
Flying hardware	M10 x 3 points

Accessories

IQ10-WB Steel wall bracket

*independent of limiters and driver protection circuits

Portable Speakers

iQ10

2500 Watt 2 Way
10" Powered Loudspeaker with
KLARK TEKNIK DSP Technology,
Speaker Modelling and
ULTRANET Networking

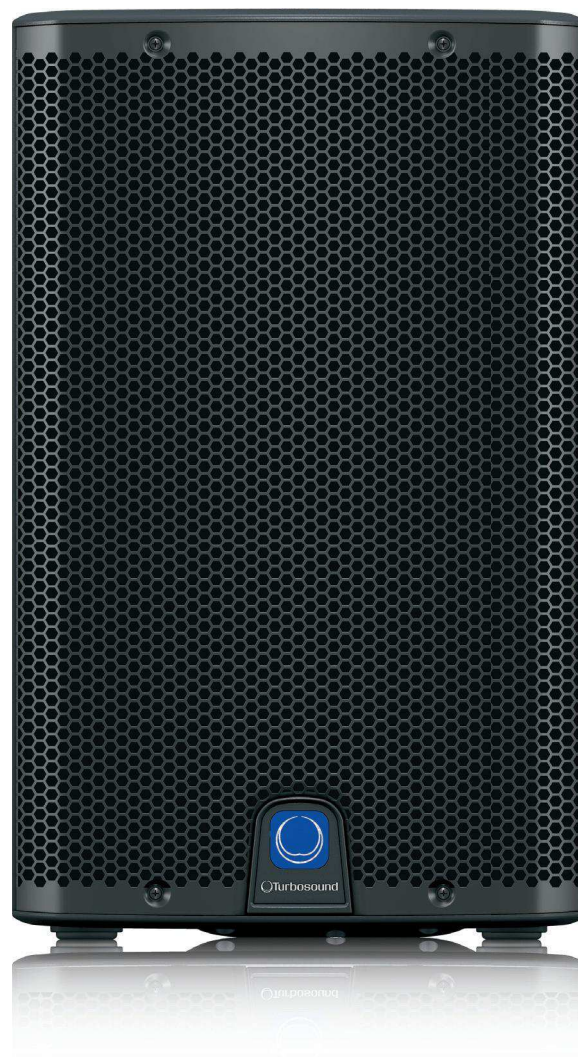

Portable Speakers

iQ10

2500 Watt 2 Way
10" Powered Loudspeaker with
KLARK TEKNIK DSP Technology,
Speaker Modelling and
ULTRANET Networking



iQ10

2500 Watt 2 Way
10" Powered Loudspeaker with
KLARK TEKNIK DSP Technology,
Speaker Modelling and
ULTRANET Networking



For service, support or more information contact the TURBOSOUND location nearest you:

Europe
MUSIC Group Services UK
Tel: +44 1562 547 100
Email: CARE@music-group.com

USA/Canada
MUSIC Group Services NV Inc.
Tel: +1 702 963 1300
Email: CARE@music-group.com

Japan
MUSIC Group Services JP K.K.
Tel: +81 3 5833 9121
Email: CARE@music-group.com

MUSIC Group accepts no liability for any loss which may be suffered by any person who relies either wholly or in part upon any description, photograph, or statement contained herein. Technical specifications, appearances and other information are subject to change without notice. All trademarks are the property of their respective owners. MIDAS, KLARK TEKNIK, LAB GRUPPEN, LAKE, TANNOY, TURBOSOUND, TC ELECTRONIC, TC HELICON, BEHRINGER, BUGERA and COOLAUDIO are trademarks or registered trademarks of MUSIC Group IP Ltd.
© MUSIC Group IP Ltd. 2018 All rights reserved.