

Touring Speakers

FLASHLINE MONITOR TFM152M-AN

Co-axial 2500 Watt
2 Way 15" Stage Monitor with
KLARK TEKNIK DSP Technology
and ULTRANET



- 2 way stage monitor for touring applications
- 2,500 Watt power featuring KLARK TEKNIK Class-D technology
- KLARK TEKNIK Digital Signal Processing for total system control
- ULTRANET digital audio networking connects to mixers and other sources
- Carbon fibre loaded 15" neodymium motor low frequency driver
- Titanium dome 1.4" neodymium motor compression driver
- Low profile design to maximise audience sight lines
- Low distortion waveguide provides 60° H x 40° V dispersion
- Fully featured user interface with LCD display for ease of navigation
- PC remote control software downloadable at turbosound.com
- 15 mm (5/8") plywood enclosure with fibre glass reinforced composite end cheeks
- Hard wearing semi matt black paint finish
- Rugged powder coated perforated steel mesh grille
- Durable handle for easy lifting and carrying
- Mains input and link output on Neutrik powerCON* connectors
- 3-Year Warranty Program*
- Designed and engineered in the U.K.

The 2-way full range TFM152M-AN is a 2,500 Watt 15" powered loudspeaker system that is ideally suited for a wide range of portable speech and music sound reinforcement applications. Designed to work individually without a controller, the TFM152M-AN provides optimal performance for wedge monitoring and is an exceptional choice for FOH, sidefill and delay line applications.



Custom-Engineered Drivers

TURBOSOUND is recognised the world over for designing and building some of the most iconic loudspeakers and subwoofers. We take meticulous care and pride in maintaining that reputation by utilising only drivers designed specifically for each application – it's what sets us apart from the competition. The TFM152M-AN loudspeaker features a carbon fibre loaded 15" neodymium low frequency driver and a titanium dome 1.4" neodymium high frequency compression driver, which is mounted on a 60° horizontal by 40° vertical dispersion low distortion waveguide.

*All third-party trademarks are the property of their respective owners. Their use neither constitutes a claim of the trademark nor affiliation of the trademark owners with MUSIC Group. Product names are mentioned solely as a reference for compatibility, effects and/or components. Warranty details can be found at music-group.com.

FLASHLINE MONITOR

TFM152M-AN

Co-axial 2500 Watt
2 Way 15" Stage Monitor with
KLARK TEKNIK DSP Technology
and ULTRANET

Class-D – Massive Power, Perfect Sound

Equipped with a very efficient and lightweight **KLARK TEKNIK** Class-D power amplifier, the TFM152M-AN provides an impressive 2,500 Watts of output power in a highly portable and lightweight package. Class-D amplification makes all the difference, offering the ultimate in energy efficiency and eliminating the need for heavy power supplies and large heat sinks.

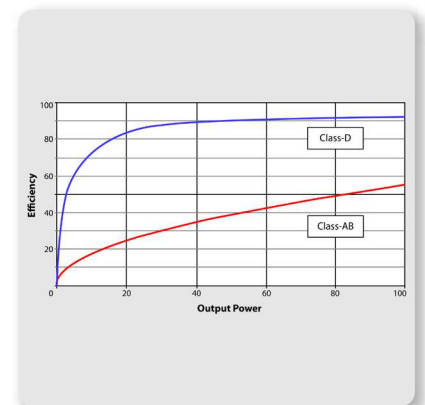

Onboard DSP

A high degree of control over the loudspeaker system's performance is managed by a sophisticated, but easy to use **KLARK TEKNIK** Digital Signal Processor (DSP), which provides dynamic EQ and transparent limiting for the utmost punch and definition at high output levels – and long-term reliability.

ULTRANET Connectivity

ULTRANET connectivity is provided by two locking etherCON* connectors. Up to 16 independent channels of 24-bit digital audio and control data are transmitted via a single CAT5 cable between compatible digital devices – including mixers, I/O stage boxes, powered loudspeakers and personal monitoring systems. Simplified cable routing and ease of setup translate directly into significant time saved during installation.



FLASHLINE MONITOR

TFM152M-AN

Co-axial 2500 Watt
2 Way 15" Stage Monitor with
KLARK TEKNIK DSP Technology
and ULTRANET



Intuitive User Interface

On the rear panel of the amplifier module, the user interface's LCD display and single rotary encoder provide intuitive access to: position compensation, user EQ control, subwoofer integration and signal routing features. In addition to the balanced XLR input, an XLR output is provided for daisy-chaining more active loudspeakers or for use with active subwoofers. An onboard USB port provides access for remote control of the TFM152M-AN via a free PC computer software download from turbosound.com – as well as convenient DSP firmware updates.

Plywood Construction

Finished in a highly durable semi matt black paint, the cabinet is constructed from 15 mm ($\frac{5}{8}$ ") plywood with fibre glass reinforced composite end cheeks and a rugged powder coated perforated steel mesh grille backed with reticulated foam. The TFM152M-AN includes a convenient pole mount socket for use with 35 mm poles/speaker stands to optimise coverage and a durable handle for easy transport. TFM152M-AN's low profile design provides improved audience line of sight for seamless integration into any application. Mains power input is provided via a Neutrik powerCON* connector.



Touring-Grade Performance

Designed to provide exceptional and unobtrusive onstage performance for travelling musicians, houses of worship, banquet facilities, night clubs – and a host of other venues, the 2,500-Watt TFM152M-AN puts touring-grade sound quality into a scalable loudspeaker system that is supremely portable and versatile.

Touring Speakers

FLASHLINE MONITOR TFM152M-AN

Co-axial 2500 Watt
2 Way 15" Stage Monitor with
KLARK TEKNIK DSP Technology
and ULTRANET

You Are Covered

We always strive to provide the best possible Customer Experience. Our products are made in our own MUSIC Group factory using state-of-the-art automation, enhanced production workflows and quality assurance labs with the most sophisticated test equipment available in the world. As a result, we have one of the lowest product failure rates in the industry, and we confidently back it up with a generous 3-Year Warranty program.



Touring Speakers

FLASHLINE MONITOR TFM152M-AN

Co-axial 2500 Watt
2 Way 15" Stage Monitor with
KLARK TEKNIK DSP Technology
and ULTRANET

Frequency Response Sensitivity 1 W / 1 m

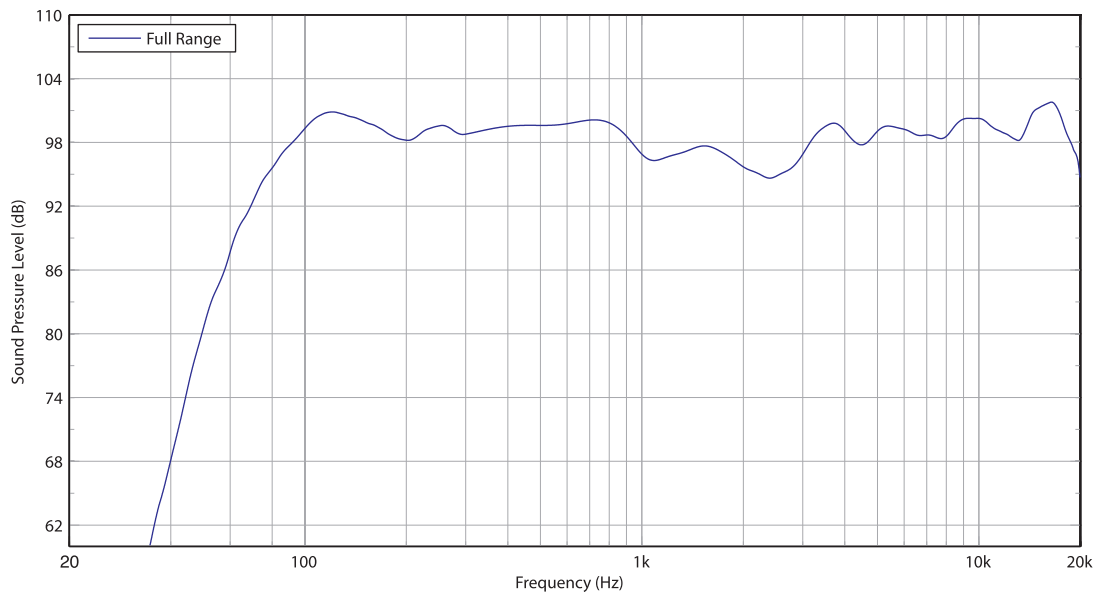

FLASHLINE MONITOR

TFM152M-AN

Co-axial 2500 Watt
2 Way 15" Stage Monitor with
KLARK TEKNIK DSP Technology
and ULTRANET

Horizontal Beamwidth

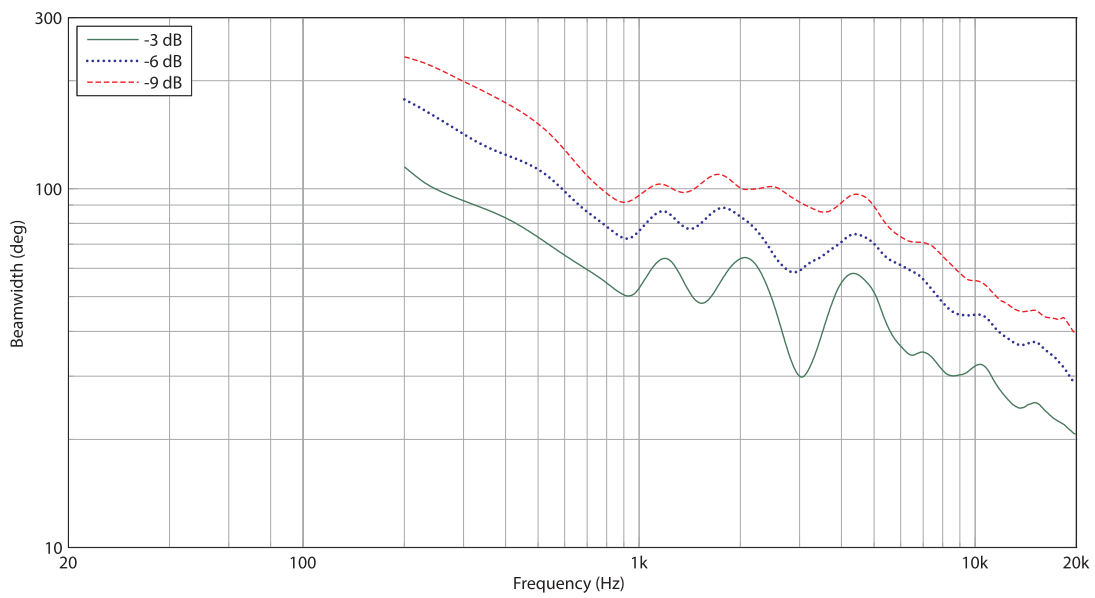

Vertical Beamwidth

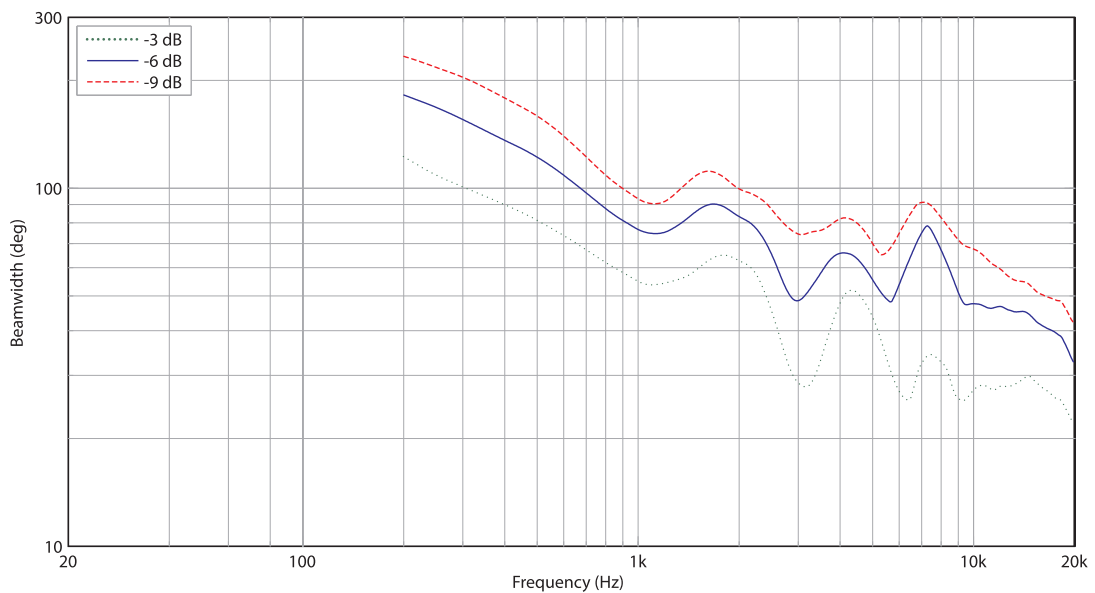

Touring Speakers

FLASHLINE MONITOR

TFM152M-AN

Co-axial 2500 Watt
2 Way 15" Stage Monitor with
KLARK TEKNIK DSP Technology
and ULTRANET

Horizontal Polar Plots

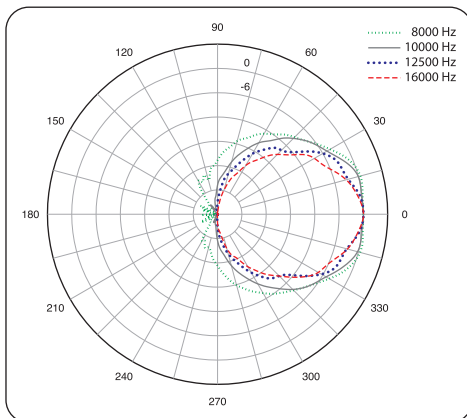
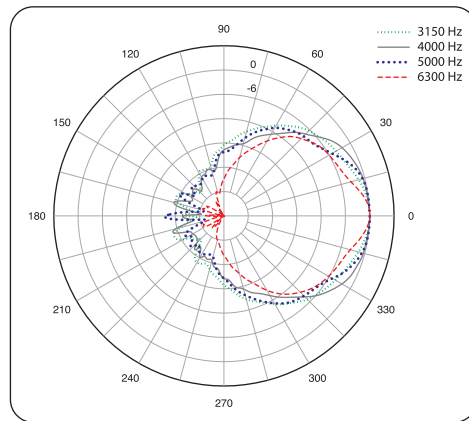
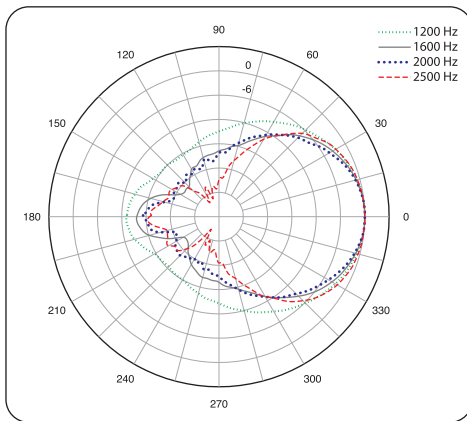
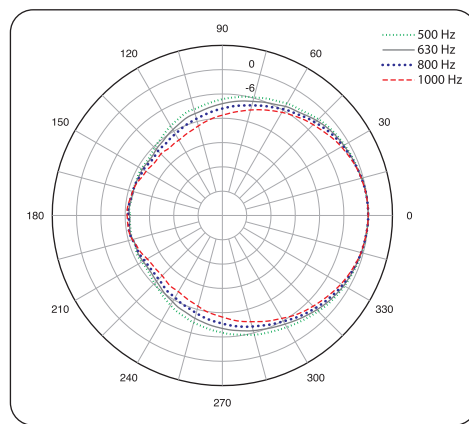
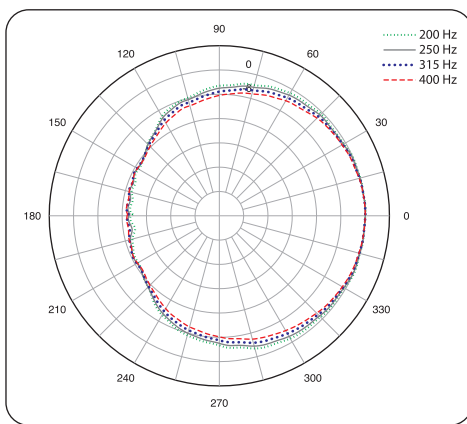

Touring Speakers

FLASHLINE MONITOR

TFM152M-AN

Co-axial 2500 Watt
2 Way 15" Stage Monitor with
KLARK TEKNIK DSP Technology
and ULTRANET

Vertical Polar Plots

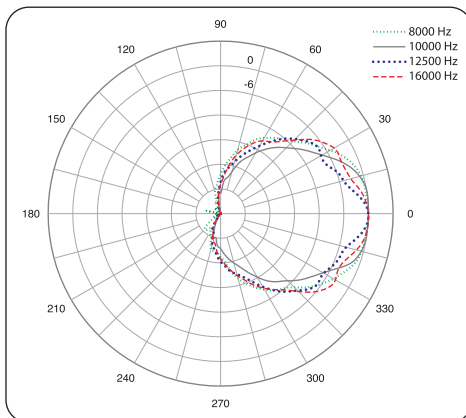
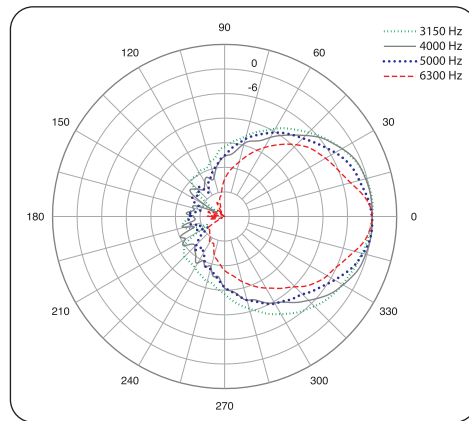
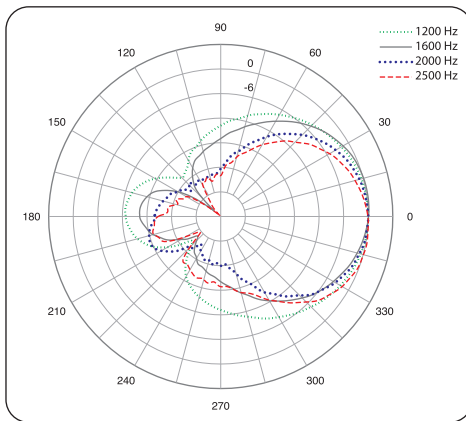
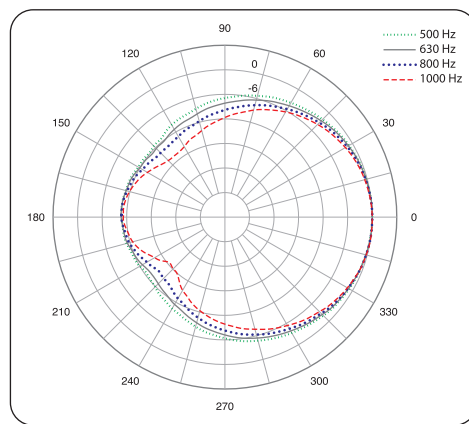
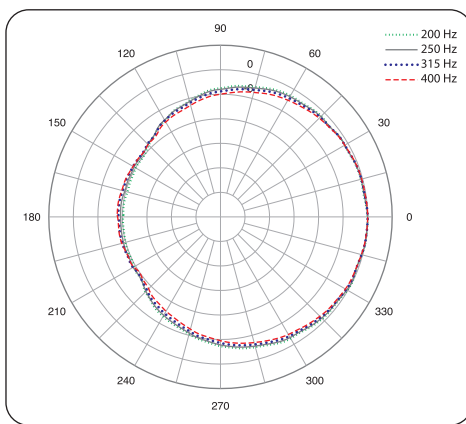

Touring Speakers

FLASHLINE MONITOR TFM152M-AN

Co-axial 2500 Watt
2 Way 15" Stage Monitor with
KLARK TEKNIK DSP Technology
and ULTRANET

Dimensions

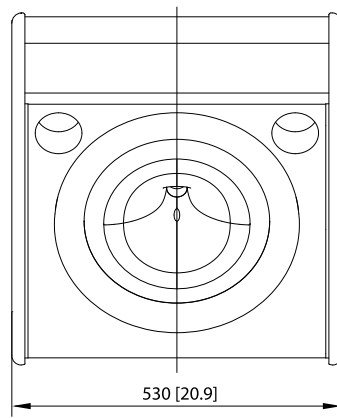

TOP

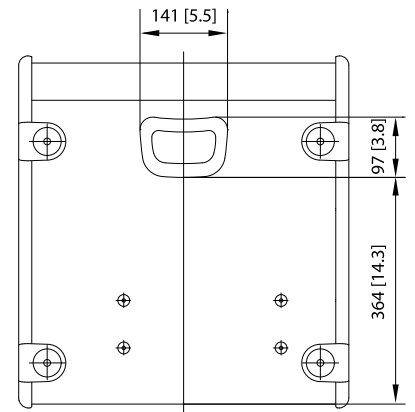

BOTTOM

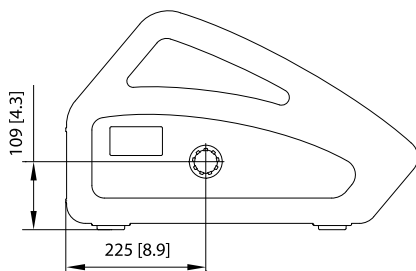

LEFT

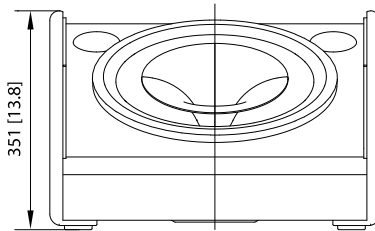

FRONT

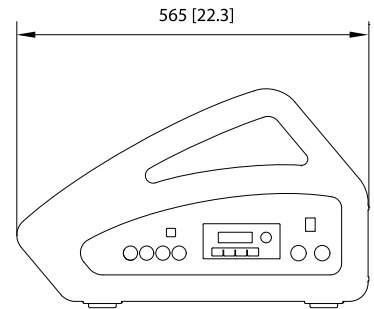

RIGHT

Touring Speakers

FLASHLINE MONITOR

TFM152M-AN

Co-axial 2500 Watt
2 Way 15" Stage Monitor with
KLARK TEKNIK DSP Technology
and ULTRANET

Technical Specifications

System

Frequency Response	60 Hz – 18 kHz \pm 3 dB 50 Hz – 20 kHz -10 dB
Nominal Dispersion	60° H x 40° V @ -6 dB points, rotatable
Maximum SPL	132 dB peak
Crossover type	Active
Transducers	1 x 15" (393.5 mm) LF driver 1 x 1.4" (33 mm) HF compression driver
Limiter	Independent HF, LF, peak and rms

Amplifier

Maximum output power*	2500 W*
Type	Class-D
Protection	Short circuit, thermal

Connectors

Input / Link	1 x combo jack/XLR, 1 x XLR
Sensitivity	-2 dBu
Input impedance	40 k Ω balanced
Maximum input level	+12.5 dBu
Ultranet input/link	2 x RJ45
Mains Supply	Neutrik powerCON input 20A and link 15A†

Controls

DSP	Rotary push-encoder and level control Buttons for Process, Setup, Exit, Enter
-----	----------------------------------------------------------------------------------

User DSP Functions

Factory EQ presets	Positioning, Sound mode, FBQ
Display	LCD 128 x 32, blue , backlit
Delay	0 - 300 ms
Equalisation	High and low shelving EQ, 2 x parametric EQ
Limiter	Zero attack input limiter
Presets	20 total presets, 19 user-defi nable
Crossover	High pass L-R 24 dB/oct
Protection	Lock-out function for all settings

Ultranet Digital Network

Digital processing	
Factory EQ presets	24-bit, 44.1 / 48 kHz sample rate
System	
Signal	16 channels
Latency	< 0.9 ms
Cabling	
Cables	Shielded CAT5
Cable length	max. 246 ft / 75 m recommended

Touring Speakers

FLASHLINE MONITOR

TFM152M-AN

Co-axial 2500 Watt
2 Way 15" Stage Monitor with
KLARK TEKNIK DSP Technology
and ULTRANET

Power Supply

Power consumption	180 W @ 1/8 max power**
Voltage (fuses)	
USA / Canada	120 V~, 60 Hz (T 15 A H 250 V)
UK / Australia / Europe	220-240 V~, 50/60 Hz (T 10 A H 250 V)
Korea / China	220-240 V~, 50/60 Hz (T 10 A H 250 V)
Japan	100 V~, 50/60 Hz (T 15 A H 250 V)

Enclosure

Dimensions (H x W x D)	351 x 530 x 565 mm (13.8 x 20.9 x 22.3")
Net weight	20.2 kg (44.5 lbs)
Construction	15 mm (5/8") birch plywood + polypropylene plastic
Finish	Semi matt black paint
Grille	Powder coated perforated steel
Flying hardware	N/A

*independent of limiters and driver protection circuits.

†Only qualified personnel are allowed to modify the AC-Main cord and to adhere to all applicable national standards.

**Power consumption for a single device only.

Touring Speakers

FLASHLINE MONITOR

TFM152M-AN

Co-axial 2500 Watt
2 Way 15" Stage Monitor with
KLARK TEKNIK DSP Technology
and ULTRANET



FLASHLINE MONITOR TFM152M-AN

Co-axial 2500 Watt
2 Way 15" Stage Monitor with
KLARK TEKNIK DSP Technology
and ULTRANET



FLASHLINE MONITOR

TFM152M-AN

Co-axial 2500 Watt
2 Way 15" Stage Monitor with
KLARK TEKNIK DSP Technology
and ULTRANET



Touring Speakers

FLASHLINE MONITOR TFM152M-AN

Co-axial 2500 Watt
2 Way 15" Stage Monitor with
KLARK TEKNIK DSP Technology
and ULTRANET



For all help, support or more information contact the TURBOSOUND location nearest you!

Europe
MUSIC Group Services UK
Tel: +44 (0) 271 2296
Email: CARE@music-group.com

USA/Canada
MUSIC Group Services NY Inc.
Tel: +1 781 806 6296
Email: CARE@music-group.com

Japan
MUSIC Group Services JP K.K.
Tel: +81 (0) 6331 0454
Email: CARE@music-group.com

MUSIC Group accepts no liability for any loss which may be suffered by any person who relies either wholly or in part upon any description, photograph, or statement contained herein. The product specifications, appearance and other information are subject to change without notice. All trademarks are the property of their respective owners. MDAI, KLARK TEKNIK, LAB GRUPPER, LARK, THORNTON, TURBOSOUND, TC ELECTRONIC, TC INFLIGHT, 94488822, 866226 and DSA are trademarks or registered trademarks of MUSIC Group IP Ltd © MUSIC Group IP Ltd. 2016. All rights reserved.