

Install Speakers

DUBLIN TCX118B-R

18" Band Pass Subwoofer for Installation
Applications (Weather Resistant)

- Band pass subwoofer for fixed installation applications
- 1,000 Watts continuous, 4,000 Watts peak power
- All components weather resistant to IP54 for outdoor use
- Double suspension 18" low frequency driver with inside/outside wound coil
- Low distortion dual port design for maximum sound pressure level
- 15 mm (5/8") birch plywood enclosure with hard wearing semi matt black paint finish
- Integral M10 rigging points for ease of installation
- Captive cable tail with sealed cable gland on aluminium connector panel
- 3-Year Warranty Program*
- Designed and engineered in England



The DUBLIN TCX118B-R is a 4,000 Watt 18" dual ported bandpass enclosure that is optimally tuned for extended low frequency response. Engineered to work in conjunction with **TURBOSOUND** loudspeaker management systems, the TCX118B-R provides very high output FOH performance and is ideally suited for a wide range of music and live sound reinforcement applications.



Custom-Engineered Drivers

TURBOSOUND is recognised the world over for designing and building some of the most iconic loudspeakers and subwoofers. We take meticulous care and pride in maintaining that reputation by utilising only drivers designed specifically for each application – it's what sets us apart from the competition.

The TCX118B-R features a powerful, double suspension 18" low frequency driver that utilises a special inside/outside wound voice coil for higher magnetic density, better heat dissipation, high power handling capacity, and improved efficiency. For its size and operating bandwidth, the TCX118B-R delivers extremely

high and virtually distortion-free output for world-class low frequency performance that will stand the test of time.

Install Speakers

DUBLIN TCX118B-R

18" Band Pass Subwoofer for Installation
Applications (Weather Resistant)

Bandpass Enclosure Design

Bandpass enclosures are extremely efficient, creating maximum bass output within a specific frequency range by increasing the acoustic load presented to the driver. The low distortion bandpass design utilised in the TCX118B-R reinforces the bass musical instrument frequencies, and steep cut-off slopes ensure an effective acoustic transition for use with DUBLIN Series full-range loudspeakers. A typical application could consist of an TCX118B-R providing the low-frequency bass extension for one, or two DUBLIN Series top cabinets.



Construction and Connectivity

Constructed from 15 mm ($\frac{5}{8}$ ") birch plywood, the cabinet is finished in hard wearing semi matt black textured paint and includes internal M10 threaded rigging points for use in permanent installation. The rear panel features a sealed captive cable and gland for added protection from the elements.

Install Speakers

DUBLIN TCX118B-R

18" Band Pass Subwoofer for Installation
Applications (Weather Resistant)

Designed to Weather the Elements

When permanently installed, the TCX118B-R presents a discreet appearance with no visible side handles for visually unobtrusive loudspeaker arrays. The weatherised paint, zinc plated grill with outdoor powdercoat, and weather resistant coated drivers deliver an IP54 rated package that not only provides class-leading performance, but maintains its attractive appearance for many years.



You Are Covered

We always strive to provide the best possible Customer Experience. Our products are made in our own [MUSIC Group](#) factory using state-of-the-art automation, enhanced production workflows and quality assurance labs with the most sophisticated test equipment available in the world. As a result, we have one of the lowest product failure rates in the industry, and we confidently back it up with a generous [3-Year Warranty program](#).

Install Speakers

DUBLIN

TCX118B-R

18" Band Pass Subwoofer for Installation
Applications (Weather Resistant)

Frequency Response Sensitivity 1 W / 1 m

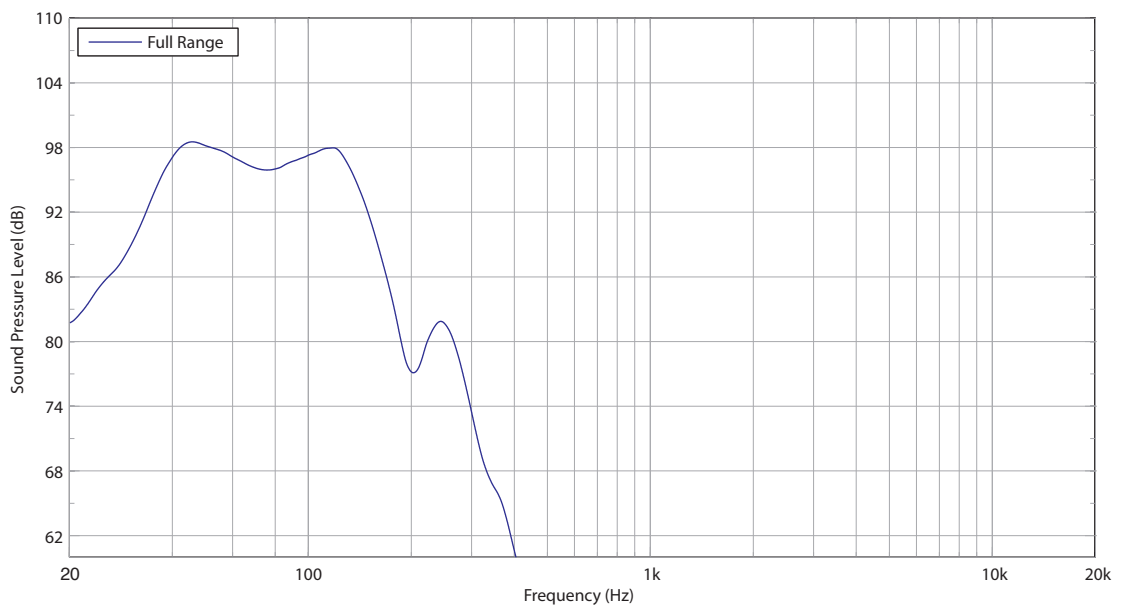

Impedance

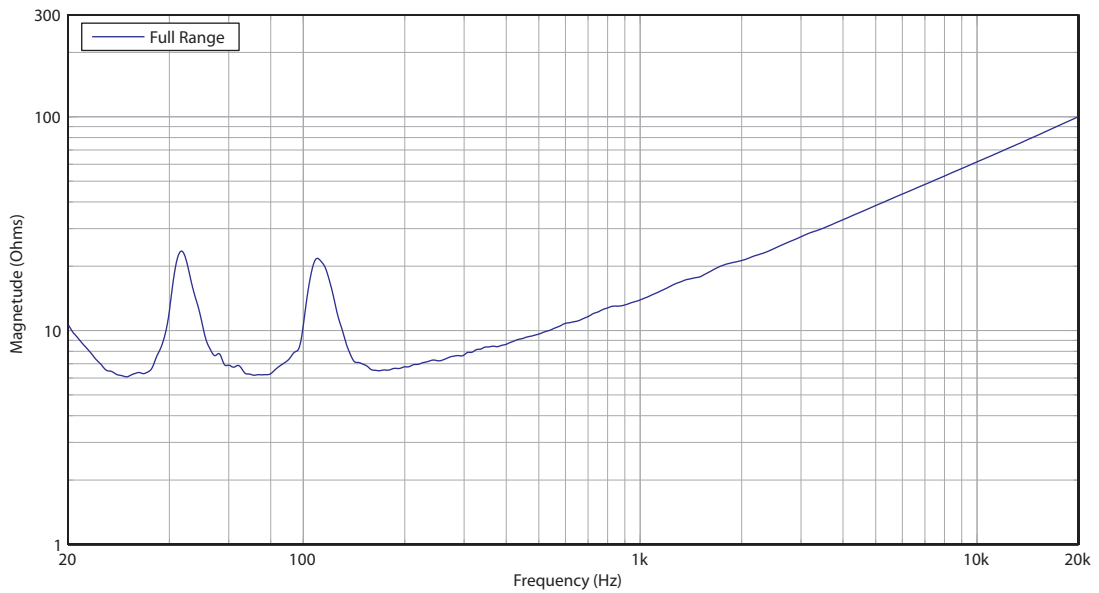

Install Speakers

DUBLIN TCX118B-R

18" Band Pass Subwoofer for Installation
Applications (Weather Resistant)

Dimensions

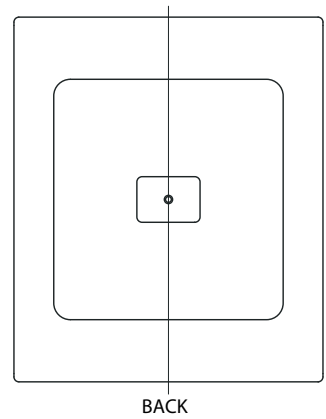
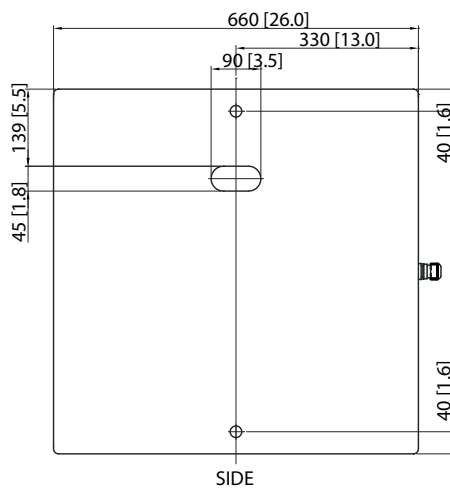
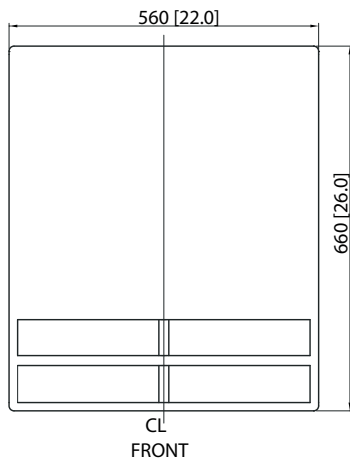
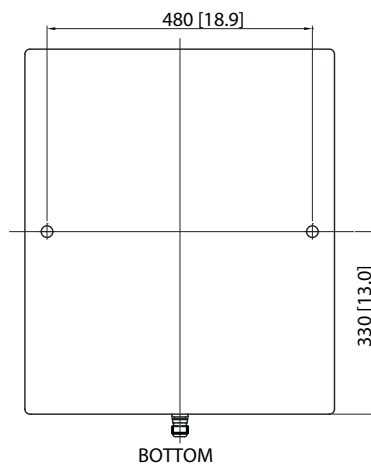
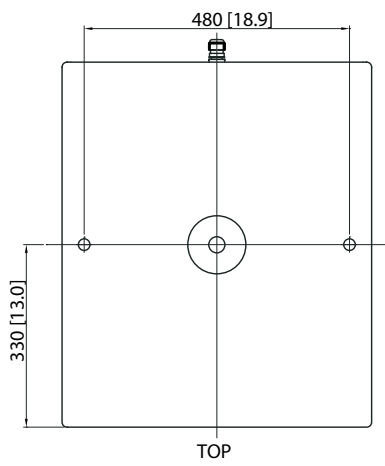

Install Speakers

DUBLIN

TCX118B-R

18" Band Pass Subwoofer for Installation
Applications (Weather Resistant)

Technical Specifications

System

Frequency response	35 Hz - 125 Hz \pm 3 dB 25 Hz - 170 Hz -10 dB
Nominal dispersion	Half space
Power handling (IEC)	1,000 W continuous, 4,000 W peak
Sensitivity	97 dB (1 W @ 1 m)
Maximum SPL	127 dB continuous, 133 dB peak
Impedance	8 Ω
Components	1 x 18" (457 mm) LF driver

Enclosure

Connectors	2-core captive cable tail
Wiring	Pins 1+ / 1- input, pins 2+ / 2- link
Dimensions HWD	660 x 560 x 660 mm (26.0 x 22.0 x 26.0")
Net weight	42.1 kg (92.6 lbs)
Construction	15 mm (5/8") birch plywood
Finish	Semi matt black paint
Grille	Powder coated perforated Zinc plated steel
Flying hardware	M10 x 8 Points

Install Speakers

DUBLIN TCX118B-R

18" Band Pass Subwoofer for Installation
Applications (Weather Resistant)

Architecture & Engineering Specifications

The loudspeaker shall be of the passive subwoofer type consisting of one 18" (457 mm) LF driver. The loudspeaker shall be weather resistant for outdoor use, to rating standard IP54. Performance specifications of a typical production unit shall meet or exceed the following: frequency response, measured with swept sine wave input, shall be flat within ± 3 dB from 35 Hz to 125 Hz and within -10 dB from 25 Hz to 170 Hz. Nominal dispersion, shall be Half Space. Nominal impedance shall be 8 Ohms. Power handling shall be 1,000 Watts continuous, 4,000 Watts peak. Sensitivity, measured on axis, mean averaged over stated bandwidth, shall be 97 dB, 1 Watt @ 1 metre. Maximum SPL (peak), measured at 1 metre with music program at stated amplifier input, shall be 133 dB. Dimensions: 660 mm high x 560 mm wide x 660 mm deep (26.0" x 22.0" x 26.0"). Net weight: 42.1 kg (92.6 lbs). The loudspeaker system shall be the [TURBOSOUND TCX118B-R](#). No other loudspeaker shall be acceptable unless submitted data from an independent test laboratory verifies that the above combined performance / size specifications are equalled or exceeded.

Install Speakers

DUBLIN TCX118B-R

18" Band Pass Subwoofer for Installation
Applications (Weather Resistant)

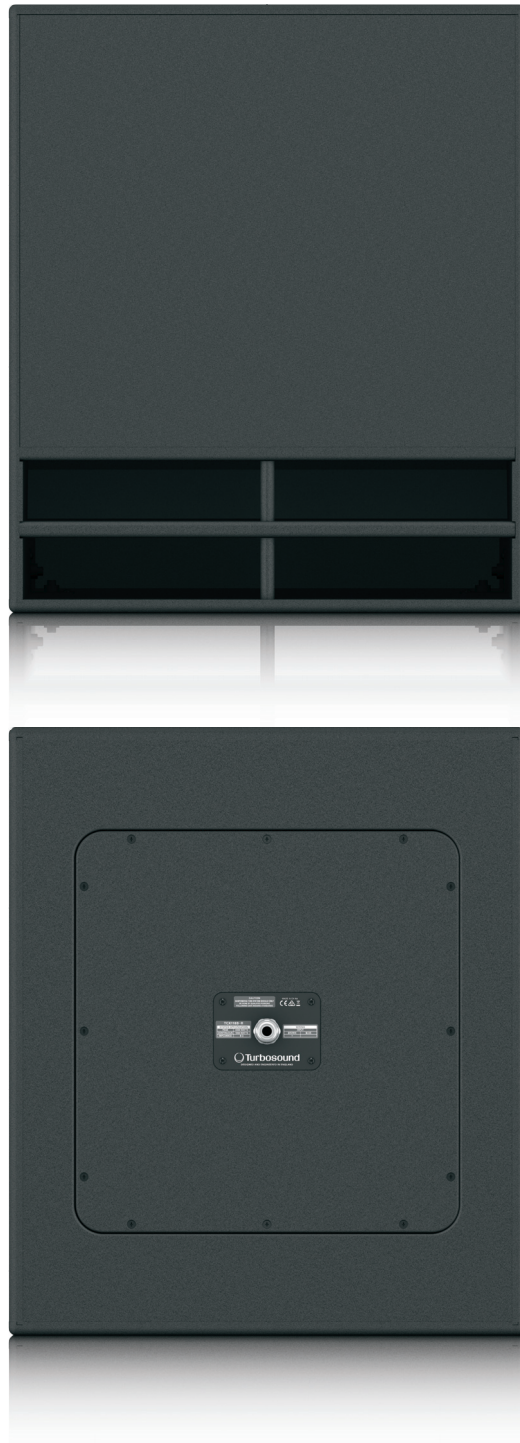

Install Speakers

DUBLIN TCX118B-R

18" Band Pass Subwoofer for Installation
Applications (Weather Resistant)



Install Speakers

DUBLIN

TCX118B-R

18" Band Pass Subwoofer for Installation
Applications (Weather Resistant)



For service, support or more information contact the TURBOSOUND location nearest you:

Europe
MUSIC Group Services UK
Tel: +44 156 273 2290
Email: CARE@music-group.com

USA/Canada
MUSIC Group Services NV Inc.
Tel: +1 702 800 8290
Email: CARE@music-group.com

Japan
MUSIC Group Services JP K.K.
Tel.: +81 3 6231 0454
Email: CARE@music-group.com

MUSIC Group accepts no liability for any loss which may be suffered by any person who relies either wholly or in part upon any description, photograph, or statement contained herein. Technical specifications, appearances and other information are subject to change without notice. All trademarks are the property of their respective owners. MIDAS, KLARK TEKNIK, TURBOSOUND, BEHRINGER, BUGERA and DDA are trademarks or registered trademarks of MUSIC Group IP Ltd. © MUSIC Group IP Ltd. 2015 All rights reserved.

