

Install Speakers

IMPACT TCI53-TR-WH

Dual 2 Way 5" Full Range Loudspeaker with Line Transformer for Installation Applications (Weather Resistant, White)

- Compact 2 way full range surface-mount loudspeaker for installation applications
- 120 Watts continuous, 480 Watts peak power
- High excursion dual 5" low frequency drivers with high temperature voice coil
- Dual 1" ferrofluid cooled neodymium high frequency drivers
- Multiple transformer taps for 70 V and 100 V line systems or 8 Ohm direct input
- Weather resistant plated perforated grille with powder coating for outdoor use
- Proprietary elliptical waveguide provides wide 100° H x 70° V dispersion
- Wall-mount bracket with integral loudspeaker connections included
- Architecturally styled glass filled impact resistant enclosure
- Semi matt white finish fits unobtrusively in any environment
- 2 x M6 rigging points compatible with TURBOSOUND and OmniMount* brackets
- 3/8" mic stand fitting for spot monitor applications
- 3-Year Warranty Program**
- Designed and engineered in England

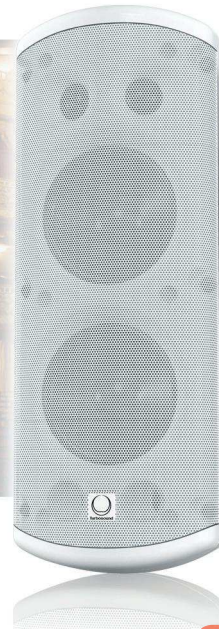

The ultra-compact IMPACT TCI53-TR-WH is an indoor/outdoor passive two way surface-mount loudspeaker that is ideally suited for a wide range of installed speech and music applications. With a power handling capacity of 480 Watts, the weather-resistant system consists of dual high excursion 5" low frequency driver with a high temperature voice coil, and dual 1" neodymium ferro-fluid cooled high frequency driver mated to a proprietary elliptical waveguide – for a wide 100° horizontal by 70° vertical dispersion pattern.

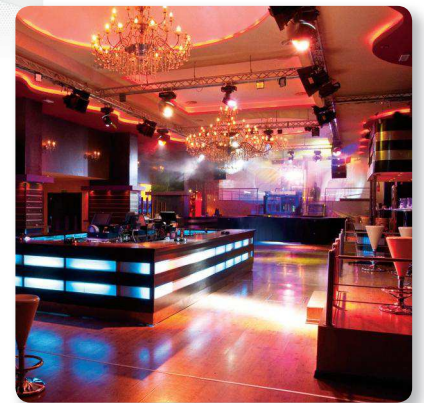

Custom-Engineered Drivers

TURBOSOUND is recognised the world over for designing and building some of the most iconic loudspeakers and subwoofers in the industry. We take meticulous care and pride in maintaining that reputation by utilising only drivers designed specifically for each application – it's what sets us apart from the competition. The custom designed dual high excursion 5" low frequency and 1" neodymium high frequency drivers ensure truly world-class performance that will deftly stand the test of time.

*All third-party trademarks are the property of their respective owners. Their use neither constitutes a claim of the trademark nor affiliation of the trademark owners with MUSIC Group. Product names are mentioned solely as a reference for compatibility, effects and/or components.

**Warranty details can be found at music-group.com.

Install Speakers

IMPACT TCI53-TR-WH

Dual 2 Way 5" Full Range Loudspeaker with
Line Transformer for Installation Applications
(Weather Resistant, White)

Internal Transformer

The TCI53-TR-WH includes an internal line transformer with multiple taps for use in 70 and 100 Volt line distributed sound applications, as well as a direct 8 Ohm input for use with low-impedance amplifiers. Taps are provided at 120, 60, and 30 Watts on the 100 V line; 120, 60, 30, and 15 Watts on the 70 V line.

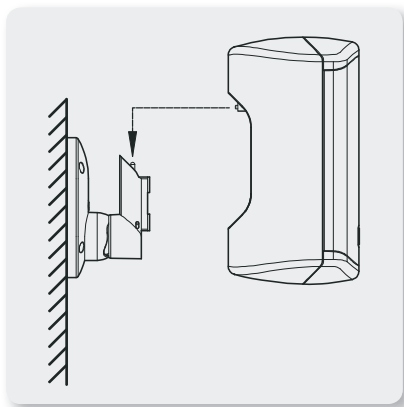

Installation and Connectivity

The TCI53-TR-WH is supplied with an adjustable wall mounting bracket that also provides the loudspeaker connections, allowing the brackets alone to be sited, installed, and wired in the early stages of building construction or remodeling – making final installation a greatly simplified and cost effective process. Threaded internal M6 rigging points are also provided for installation with [TURBOSOUND](#) wall and ceiling hardware, as well as industry standard brackets. A convenient $\frac{3}{8}$ " mic stand fitting, hidden under the EPDM rubber cover on the bottom of the cabinet, allows affixing the TCI53-TR-WH to a standard microphone stand for use as a 'spot monitor'.

Designed to Weather the Elements

When permanently installed, the architecturally styled, glass filled and impact resistant TCI53-TR-WH enclosure sports a classic semi matt white finish, which allows it to fit unobtrusively and elegantly into any environment. The included integral wall mounting bracket provides hidden cable management, completing the seamless visual presentation. The weatherised paint, zinc plated grill with outdoor powdercoat, and weather resistant coated drivers deliver an IP34 rated package that not only provides class-leading performance, but maintains its attractive appearance for many years.



Install Speakers

IMPACT

TCI53-TR-WH

Dual 2 Way 5" Full Range Loudspeaker with
Line Transformer for Installation Applications
(Weather Resistant, White)



You Are Covered

We always strive to provide the best possible Customer Experience. Our products are made in our own **MUSIC Group** factory using state-of-the-art automation, enhanced production workflows and quality assurance labs with the most sophisticated test equipment available in the world. As a result, we have one of the lowest product failure rates in the industry, and we confidently back it up with a generous **3-Year Warranty program**.

Install Speakers

IMPACT

TCI53-TR-WH

Dual 2 Way 5" Full Range Loudspeaker with Line Transformer for Installation Applications (Weather Resistant, White)

Frequency Response Sensitivity 1 W / 1 m

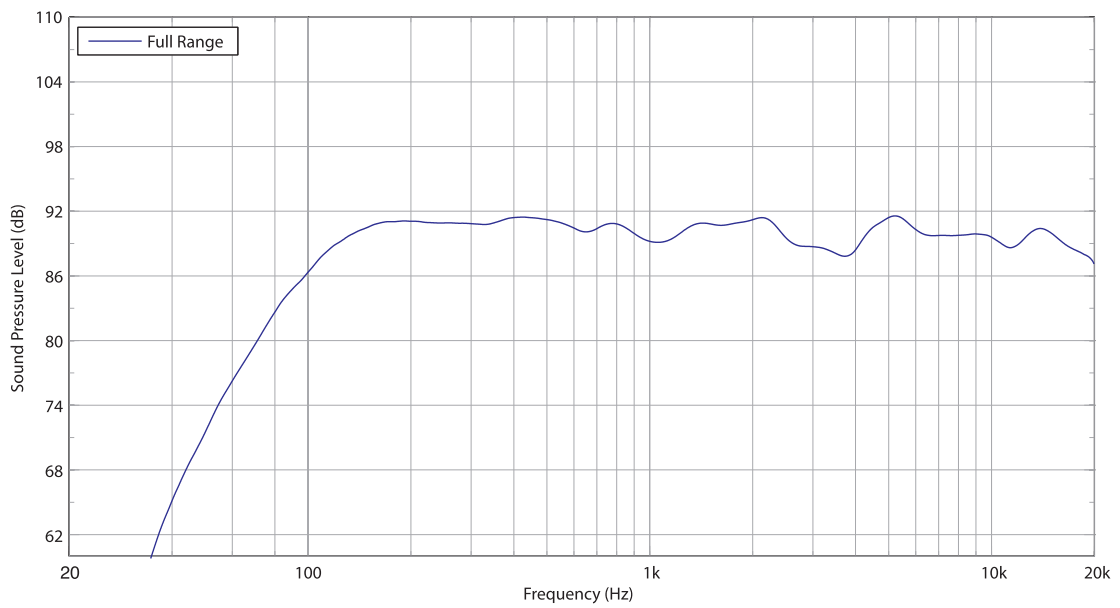

Impedance

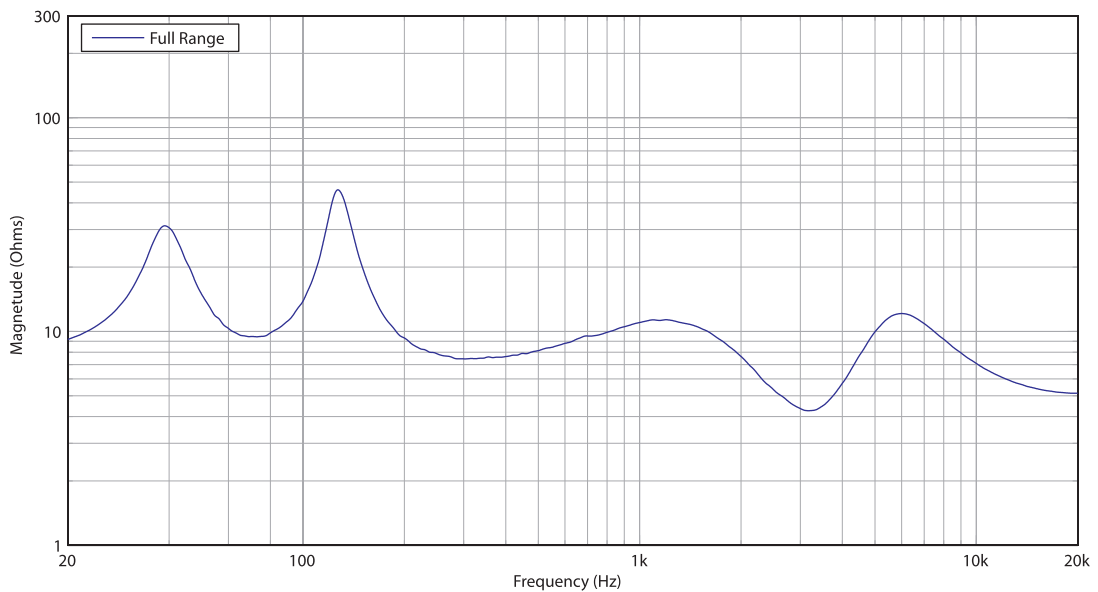

Install Speakers

IMPACT TCI53-TR-WH

Dual 2 Way 5" Full Range Loudspeaker with
Line Transformer for Installation Applications
(Weather Resistant, White)

Horizontal Beamwidth

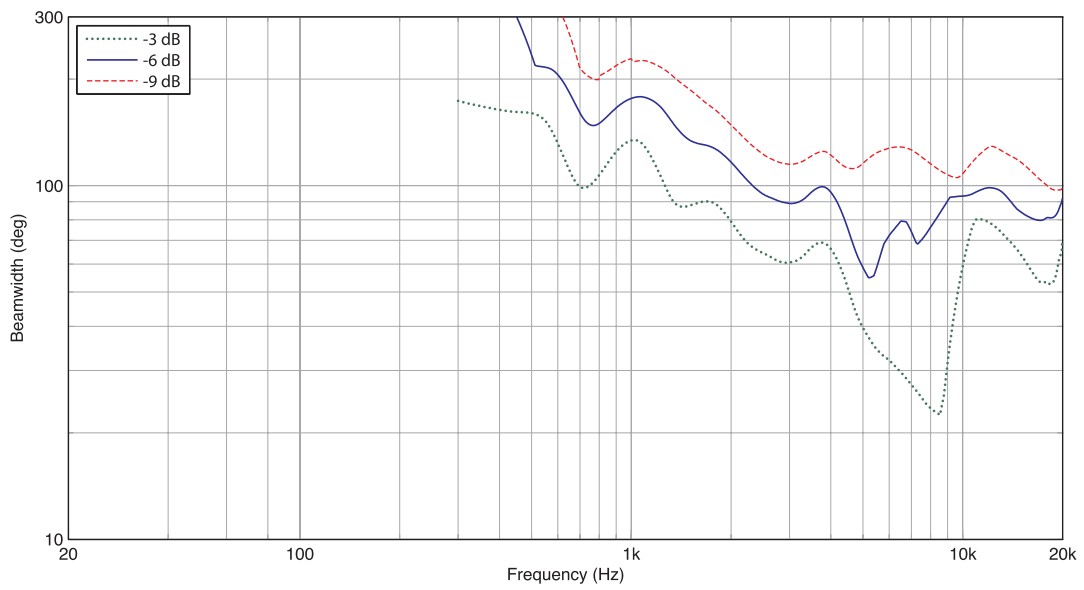

Vertical Beamwidth

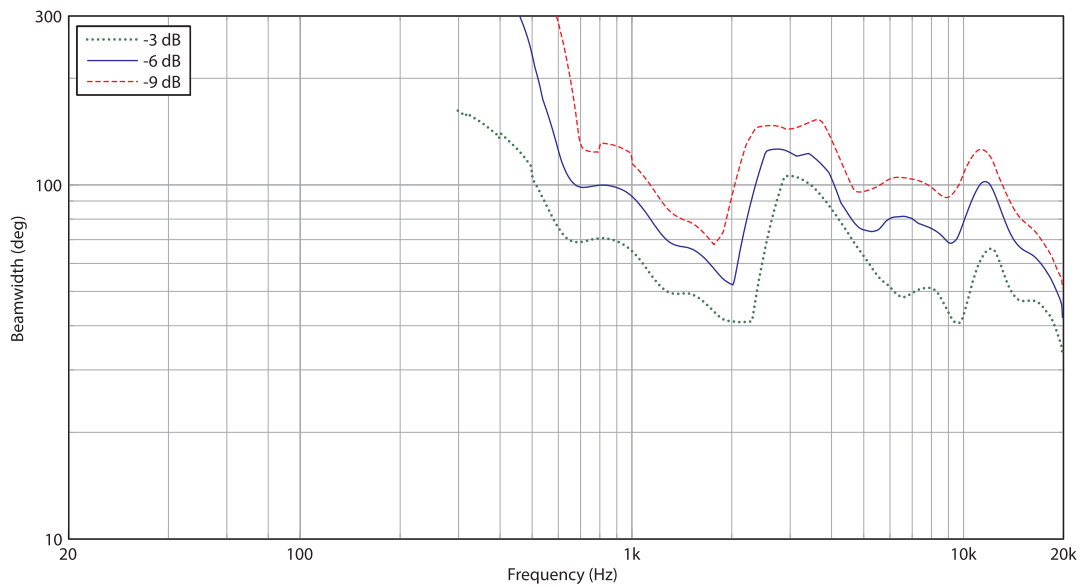

Install Speakers

IMPACT TCI53-TR-WH

Dual 2 Way 5" Full Range Loudspeaker with
Line Transformer for Installation Applications
(Weather Resistant, White)

Horizontal Polar Plots

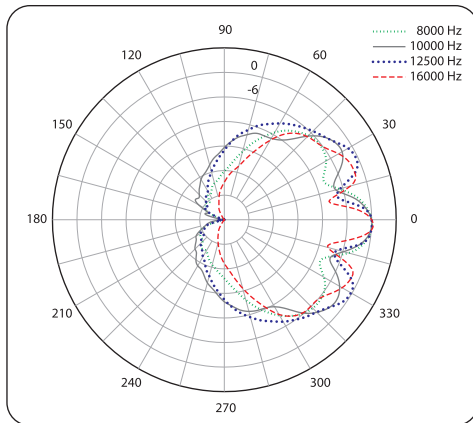
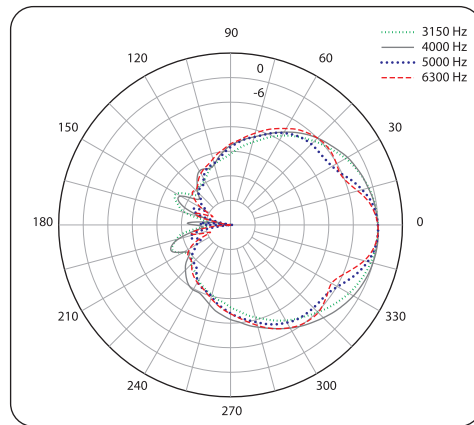
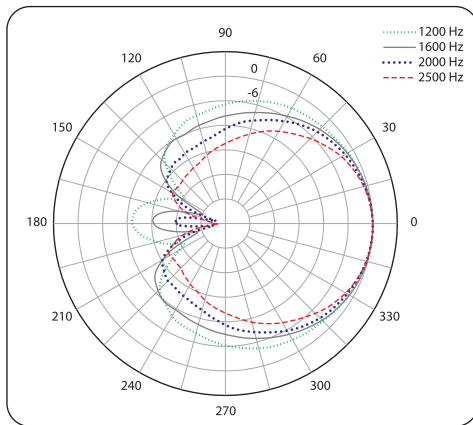
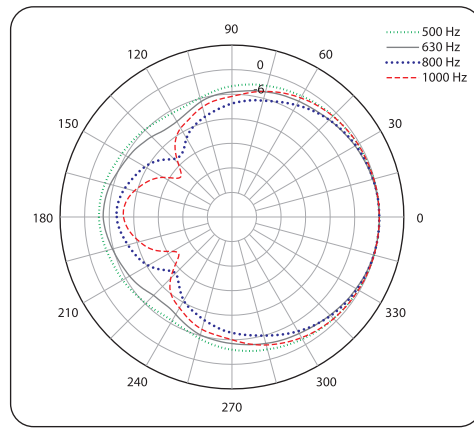
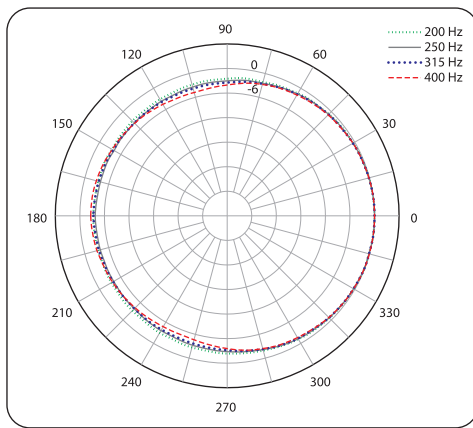

Install Speakers

IMPACT TCI53-TR-WH

Dual 2 Way 5" Full Range Loudspeaker with
Line Transformer for Installation Applications
(Weather Resistant, White)

Vertical Polar Plots

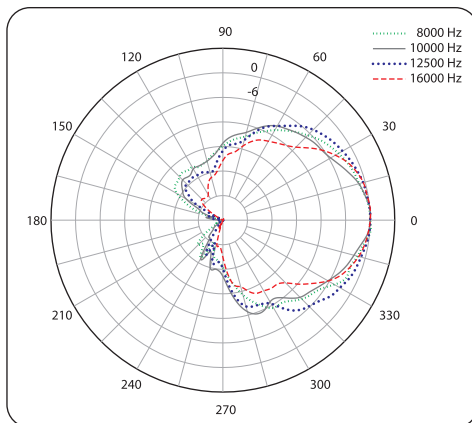
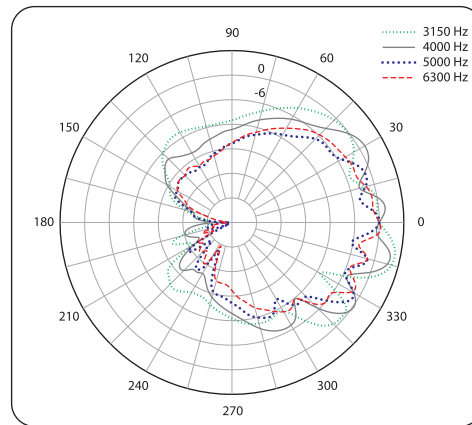
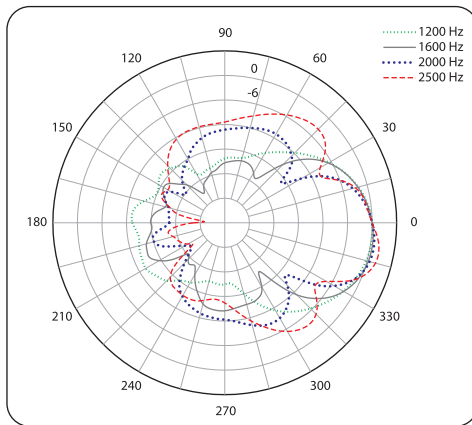
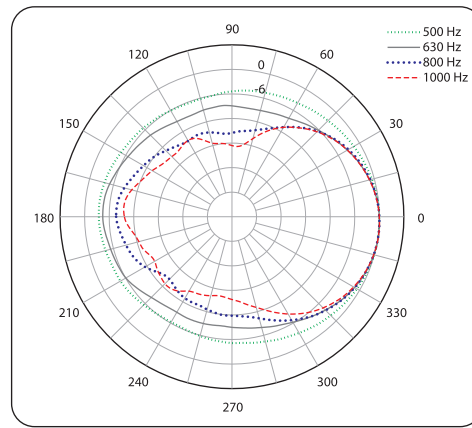
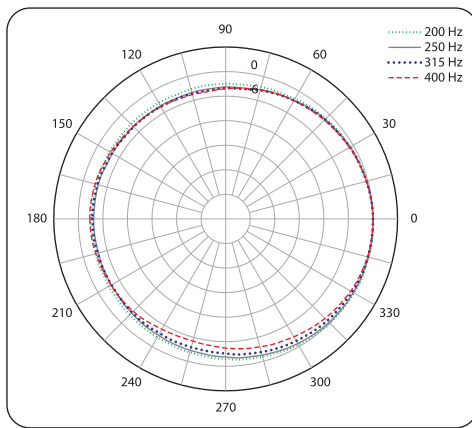

Install Speakers

IMPACT

TCI53-TR-WH

Dual 2 Way 5" Full Range Loudspeaker with Line Transformer for Installation Applications (Weather Resistant, White)

Dimensions

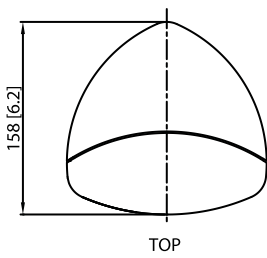

TOP

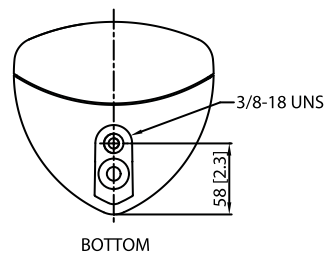

BOTTOM

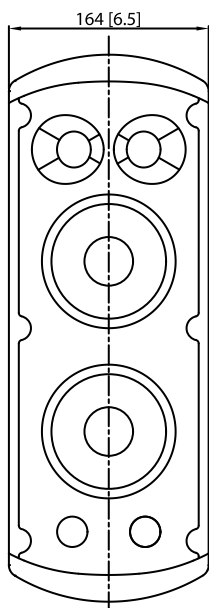

CL
FRONT

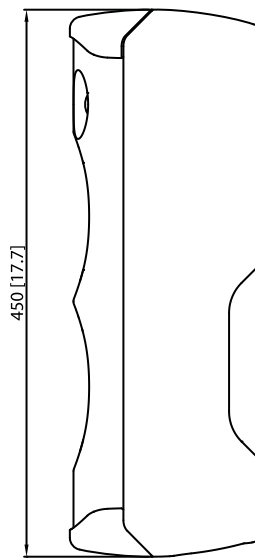

SIDE

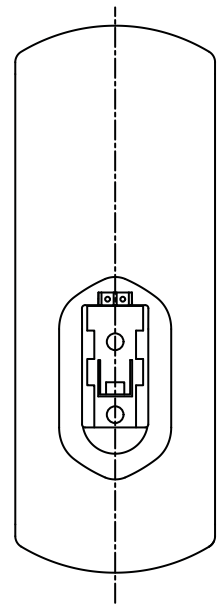

REAR

Install Speakers

IMPACT

TCI53-TR-WH

Dual 2 Way 5" Full Range Loudspeaker with
Line Transformer for Installation Applications
(Weather Resistant, White)

Technical Specifications

System

Frequency response	74 Hz - 18 kHz \pm 3 dB 43 Hz - 20 kHz -10 dB
Nominal dispersion	100° H x 70° V @ -6 dB points
Power handling (IEC)	
Passive	120 W continuous, 480 W peak
100 V line	120, 60, 30 W continuous
70 V line	120, 60, 30, 15 W continuous
Sensitivity	90 dB (1 W @ 1 m)
Maximum SPL	
Passive	111 dB continuous, 117 dB peak
100 V line	117, 114, 111 dB peak
70 V line	117, 114, 111, 105 dB peak
Impedance	8 Ω
Components	2 x 5" (127 mm) LF driver 2 x 1" (25 mm) HF soft dome driver

Enclosure

Connectors	Screw terminal block
Wiring	Input +VE, -VE
Dimensions HWD	450 x 164 x 158 mm (17.7 x 6.5 x 6.2")
Net weight	5.0 kg (11.0 lbs)
Construction	Gas injected, glass-filled moulded ABS enclosure
Finish	White (black optional)
Grille	Powder coated perforated Zinc plated steel
Flying hardware	M6 x 2 points

Accessories

Wall bracket - included

Install Speakers

IMPACT TCI53-TR-WH

Dual 2 Way 5" Full Range Loudspeaker with
Line Transformer for Installation Applications
(Weather Resistant, White)

Architecture & Engineering Specifications

The system shall be of the passive two-way type consisting of two 5" (127 mm) low frequency drivers and two 1" (25 mm) ferro-fluid cooled neodymium high frequency tweeters with integral line transformer and shall be supplied with an adjustable wall bracket providing integral electrical connections. The loudspeaker shall be weather resistant for outdoor use, to rating standard IP34. Performance specifications of a typical production unit shall meet or exceed the following: Frequency response, measured with swept sine wave input, shall be flat within ± 3 dB from 74 Hz to 18 kHz, and within -10 dB from 43 Hz to 20 kHz. Nominal dispersion, at -6 dB points, shall average 100° H x 70° V. Nominal impedance shall be 8 ohms. Power handling shall be 120 watts continuous, 480 Watts peak. Sensitivity, measured with 1 Watt input at 1 metre distance on axis, mean averaged over stated bandwidth shall be 90 dB. Maximum SPL (peak) measured with music program input at stated amplifier power shall be 117 dB. Dimensions: 450 mm high x 164 mm wide x 158 mm deep (17.7" x 6.5" x 6.2"). Net weight: 5.0 kg (11.0 lbs). The loudspeaker system shall be the [TURBOSOUND IMPACT TCI53-TR-WH](#). No other loudspeaker shall be acceptable unless submitted data from an independent test laboratory verifies that the above combined performance / size specifications are equalled or exceeded.

Install Speakers

IMPACT TCI53-TR-WH

Dual 2 Way 5" Full Range Loudspeaker with
Line Transformer for Installation Applications
(Weather Resistant, White)

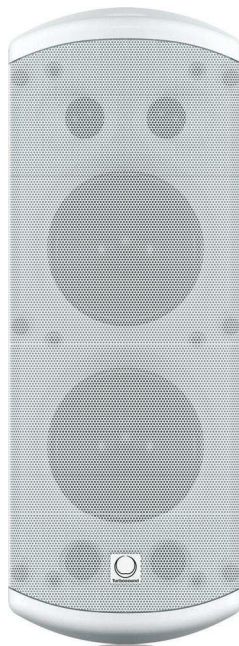

Install Speakers

IMPACT TCI53-TR-WH

Dual 2 Way 5" Full Range Loudspeaker with
Line Transformer for Installation Applications
(Weather Resistant, White)



Install Speakers

IMPACT TCI53-TR-WH

Dual 2 Way 5" Full Range Loudspeaker with
Line Transformer for Installation Applications
(Weather Resistant, White)



For service, support or more information contact the TURBOSOUND location nearest you:

Europe
MUSIC Group Services UK
Tel: +44 156 273 2290
Email: CARE@music-group.com

USA/Canada
MUSIC Group Services NV Inc.
Tel: +1 702 800 8290
Email: CARE@music-group.com

Japan
MUSIC Group Services JP K.K.
Tel: +81 3 6231 0454
Email: CARE@music-group.com

MUSIC Group accepts no liability for any loss which may be suffered by any person who relies either wholly or in part upon any description, photograph, or statement contained herein. Technical specifications, appearances and other information are subject to change without notice. All trademarks are the property of their respective owners. MIDAS, KLARK TEKNIK, TURBOSOUND, BEHRINGER, BUGERA and DDA are trademarks or registered trademarks of MUSIC Group IP Ltd. © MUSIC Group IP Ltd. 2015 All rights reserved.