

Install Speakers

IMPACT TCI32-T-WH

Pair of 2 Way 3.5" Full Range
Loudspeakers with Line Transformers
for Installation Applications (White)

- Pair of compact 2 way full range surface-mount loudspeakers for installation applications
- 30 Watts continuous, 120 Watts peak power
- High excursion 3.5" low frequency driver with high temperature voice coil
- 1" ferrofluid cooled neodymium high frequency driver
- Multiple transformer taps for 70 V and 100 V line systems or 16 Ohm direct input
- Proprietary elliptical waveguide provides wide 120° H x 100° V dispersion
- Wall-mount bracket with integral loudspeaker connections included
- Architecturally styled glass filled impact resistant enclosure
- Semi matt white finish fits unobtrusively in any environment
- 2 x M6 rigging points compatible with TURBOSOUND and OmniMount* brackets
- 3/8" mic stand fitting for spot monitor applications
- 3-Year Warranty Program**
- Designed and engineered in England

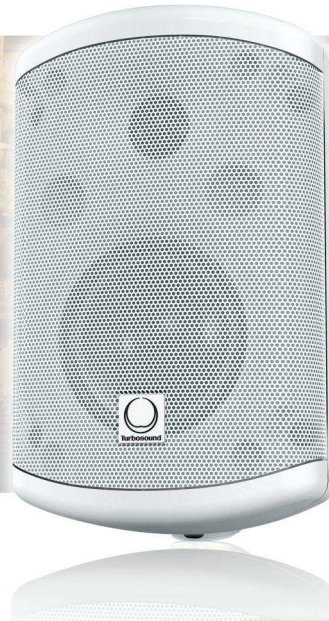

Shipped in pairs, the ultra-compact IMPACT TCI32-T-WH is a passive two way surface-mount loudspeaker that is ideally suited for a wide range of installed speech and music applications. With a power handling capacity of 120 Watts, the system consists of a high excursion 3.5" low frequency driver with a high temperature voice coil, and a 1" neodymium ferro-fluid cooled high frequency driver mated to a proprietary elliptical waveguide – for a wide 120° horizontal by 100° vertical dispersion pattern.



Custom-Engineered Drivers

TURBOSOUND is recognised the world over for designing and building some of the most iconic loudspeakers and subwoofers in the industry. We take meticulous care and pride in maintaining that reputation by utilising only drivers designed specifically for each application – it's what sets us apart from the competition. The custom designed high excursion 3.5" low frequency and 1" neodymium high frequency drivers ensure truly world-class performance that will deftly stand the test of time.

*All third-party trademarks are the property of their respective owners. Their use neither constitutes a claim of the trademark nor affiliation of the trademark owners with MUSIC Group. Product names are mentioned solely as a reference for compatibility, effects and/or components.

**Warranty details can be found at music-group.com.

Install Speakers

IMPACT TCI32-T-WH

Pair of 2 Way 3.5" Full Range
Loudspeakers with Line Transformers
for Installation Applications (White)

Internal Transformer

The TCI32-T-WH includes an internal line transformer with multiple taps for use in 70 and 100 Volt line distributed sound applications, as well as a direct 16 Ohm input for use with low-impedance amplifiers. Taps are provided at 30, 15, and 7.5 Watts on the 100 V line; 30, 15, 7.5, and 3.75 Watts on the 70 V line.



Discreet Implementation

When permanently installed, the architecturally styled, glass filled and impact resistant TCI32-T-WH enclosure sports a classic semi matt white finish, which allows it to fit unobtrusively and elegantly into any environment. The included integral wall mounting bracket provides hidden cable management, completing the seamless visual presentation.

Installation and Connectivity

The TCI32-T-WH is supplied with an adjustable wall mounting bracket that also provides the loudspeaker connections, allowing the brackets alone to be sited, installed, and wired in the early stages of building construction or remodelling – making final installation a greatly simplified and cost effective process. Threaded internal M6 rigging points are also provided for installation with **TURBOSOUND** wall and ceiling hardware, as well as industry standard brackets. A convenient $\frac{3}{8}$ " mic stand fitting, hidden under the EPDM rubber cover on the bottom of the cabinet, allows affixing the TCI32-T-WH to a standard microphone stand for use as a 'spot monitor'.

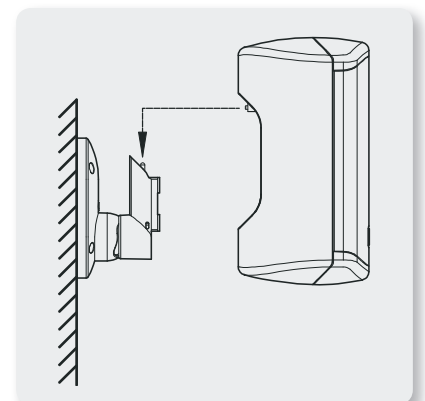

Install Speakers

IMPACT TCI32-T-WH

Pair of 2 Way 3.5" Full Range
Loudspeakers with Line Transformers
for Installation Applications (White)



You Are Covered

We always strive to provide the best possible Customer Experience. Our products are made in our own **MUSIC Group** factory using state-of-the-art automation, enhanced production workflows and quality assurance labs with the most sophisticated test equipment available in the world. As a result, we have one of the lowest product failure rates in the industry, and we confidently back it up with a generous **3-Year Warranty program**.

Install Speakers

IMPACT TCI32-T-WH

Pair of 2 Way 3.5" Full Range
Loudspeakers with Line Transformers
for Installation Applications (White)

Frequency Response Sensitivity 1 W / 1 m

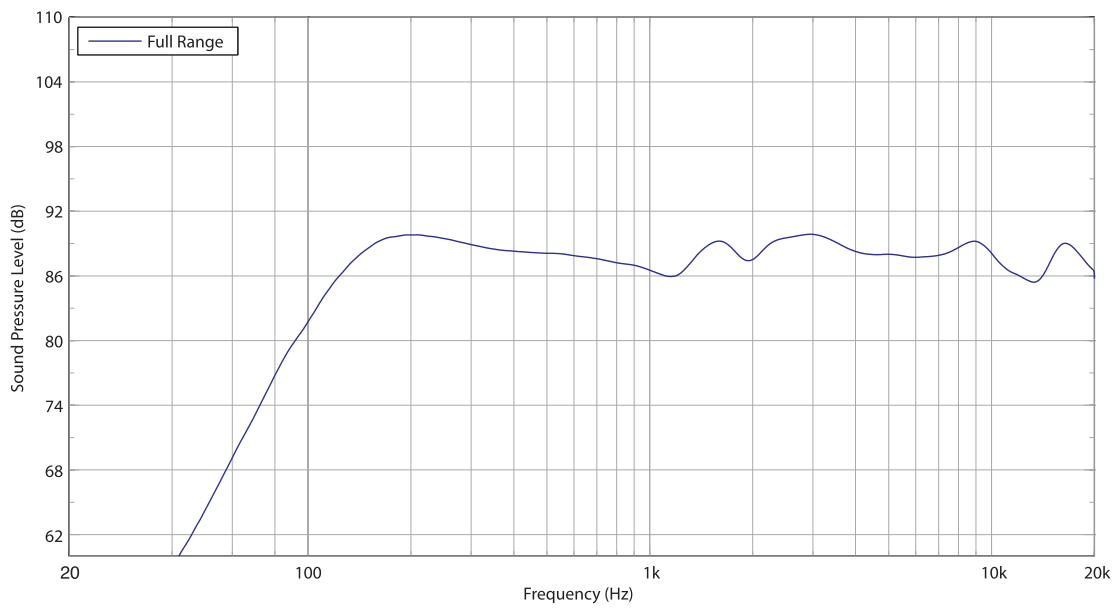

Impedance

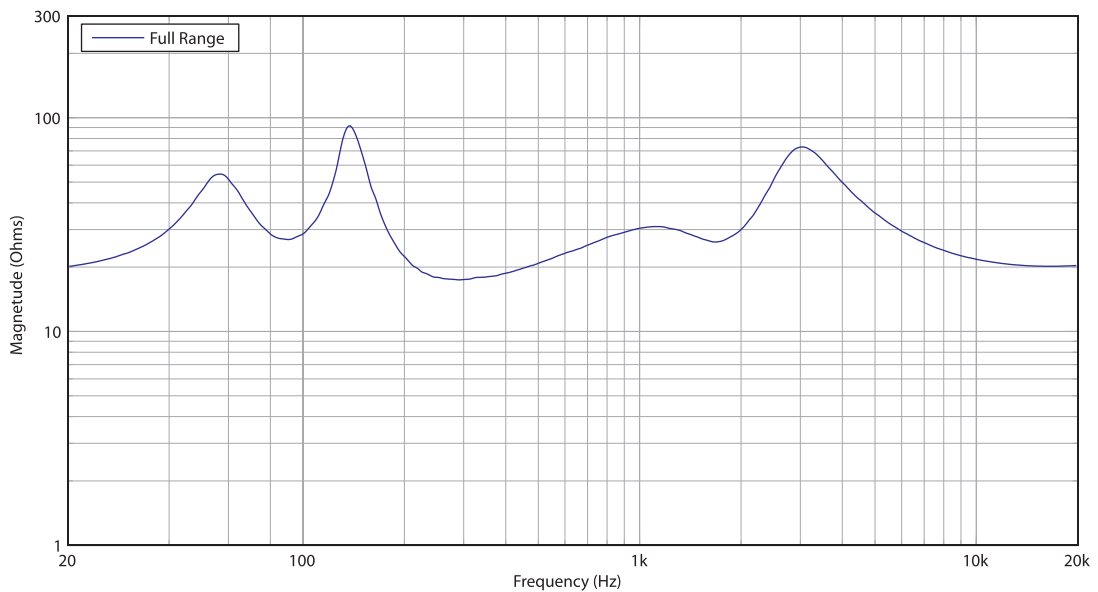

Install Speakers

IMPACT TCI32-T-WH

Pair of 2 Way 3.5" Full Range
Loudspeakers with Line Transformers
for Installation Applications (White)

Horizontal Beamwidth

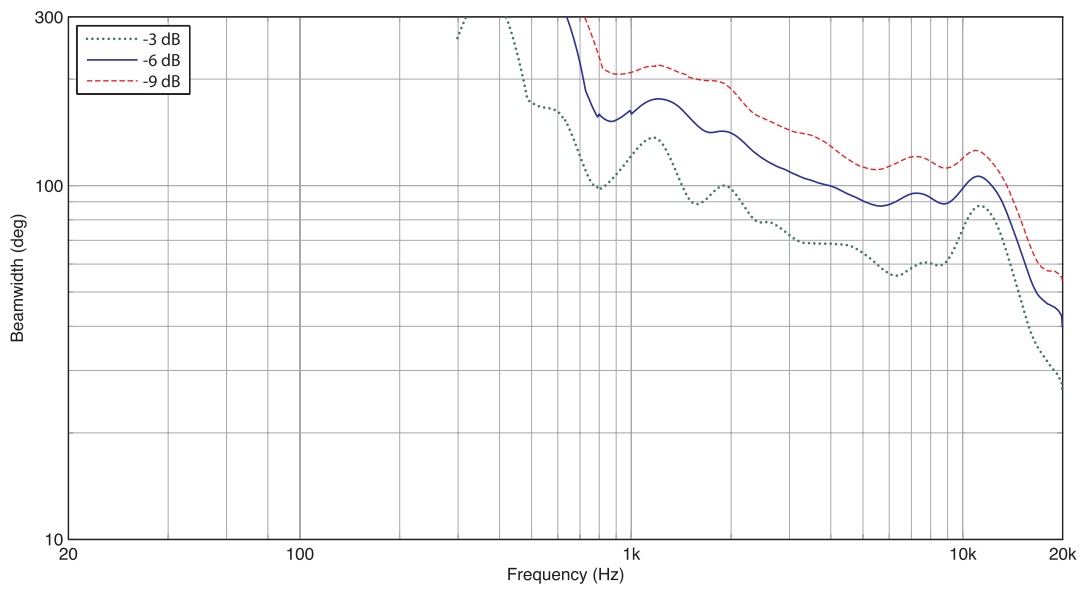

Vertical Beamwidth

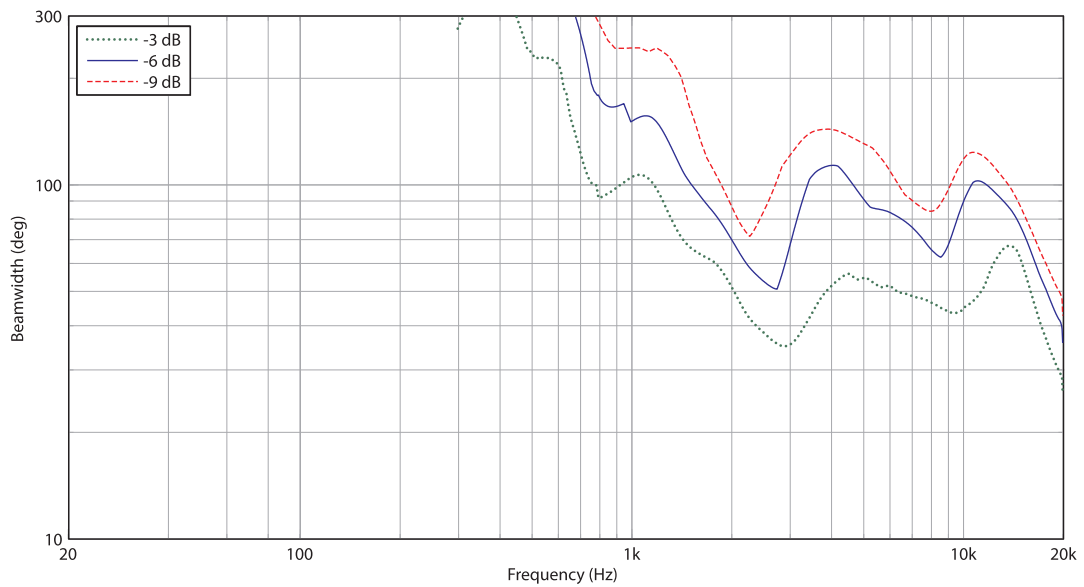

Install Speakers

IMPACT TCI32-T-WH

Pair of 2 Way 3.5" Full Range
Loudspeakers with Line Transformers
for Installation Applications (White)

Horizontal Polar Plots

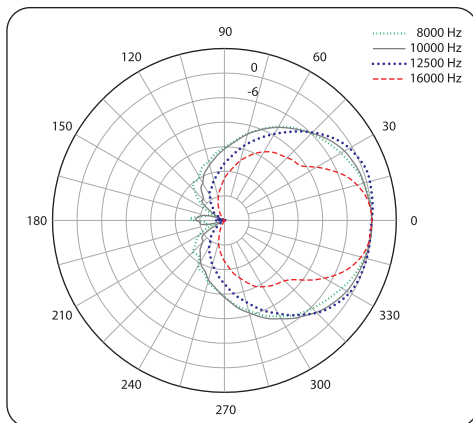
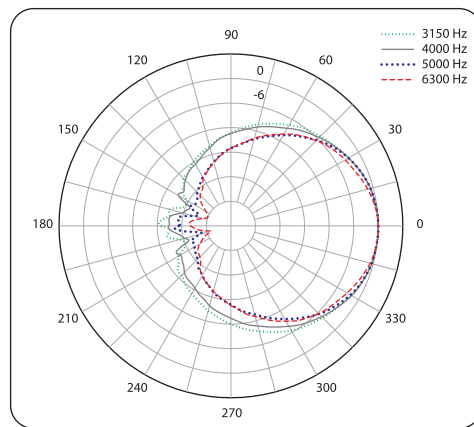
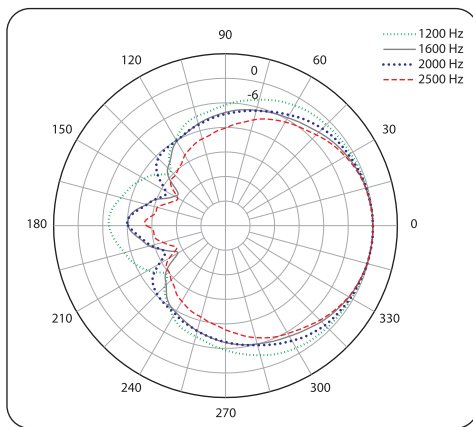
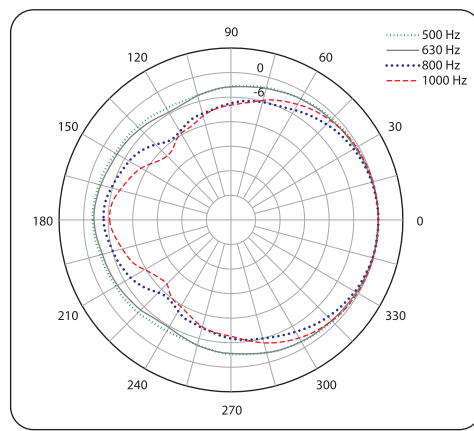
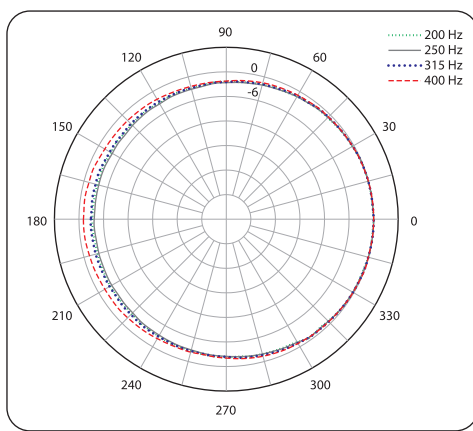

Install Speakers

IMPACT TCI32-T-WH

Pair of 2 Way 3.5" Full Range
Loudspeakers with Line Transformers
for Installation Applications (White)

Vertical Polar Plots

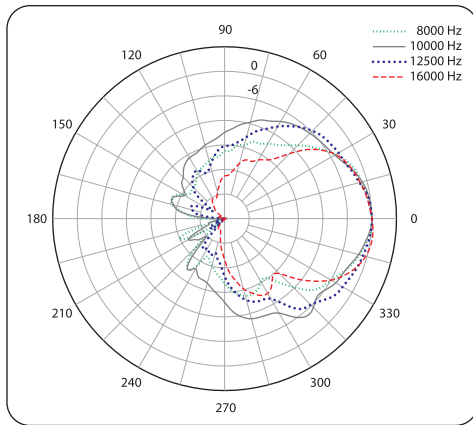
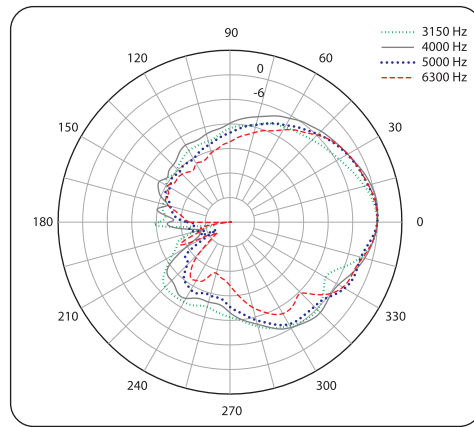
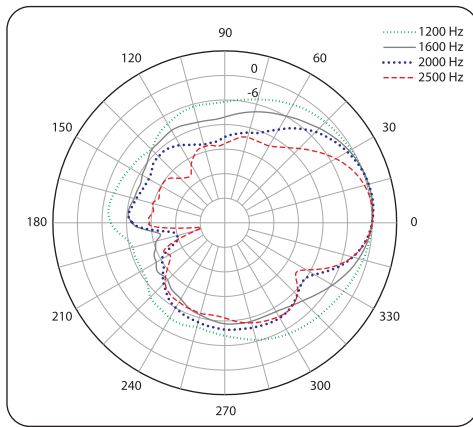
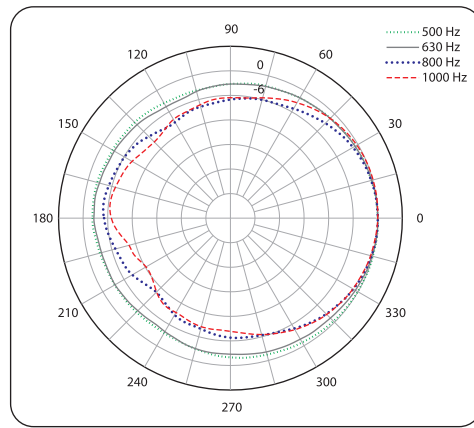
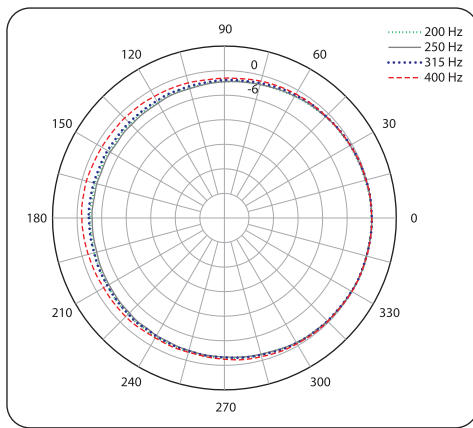

Install Speakers

IMPACT TCI32-T-WH

Pair of 2 Way 3.5" Full Range
Loudspeakers with Line Transformers
for Installation Applications (White)

Dimensions

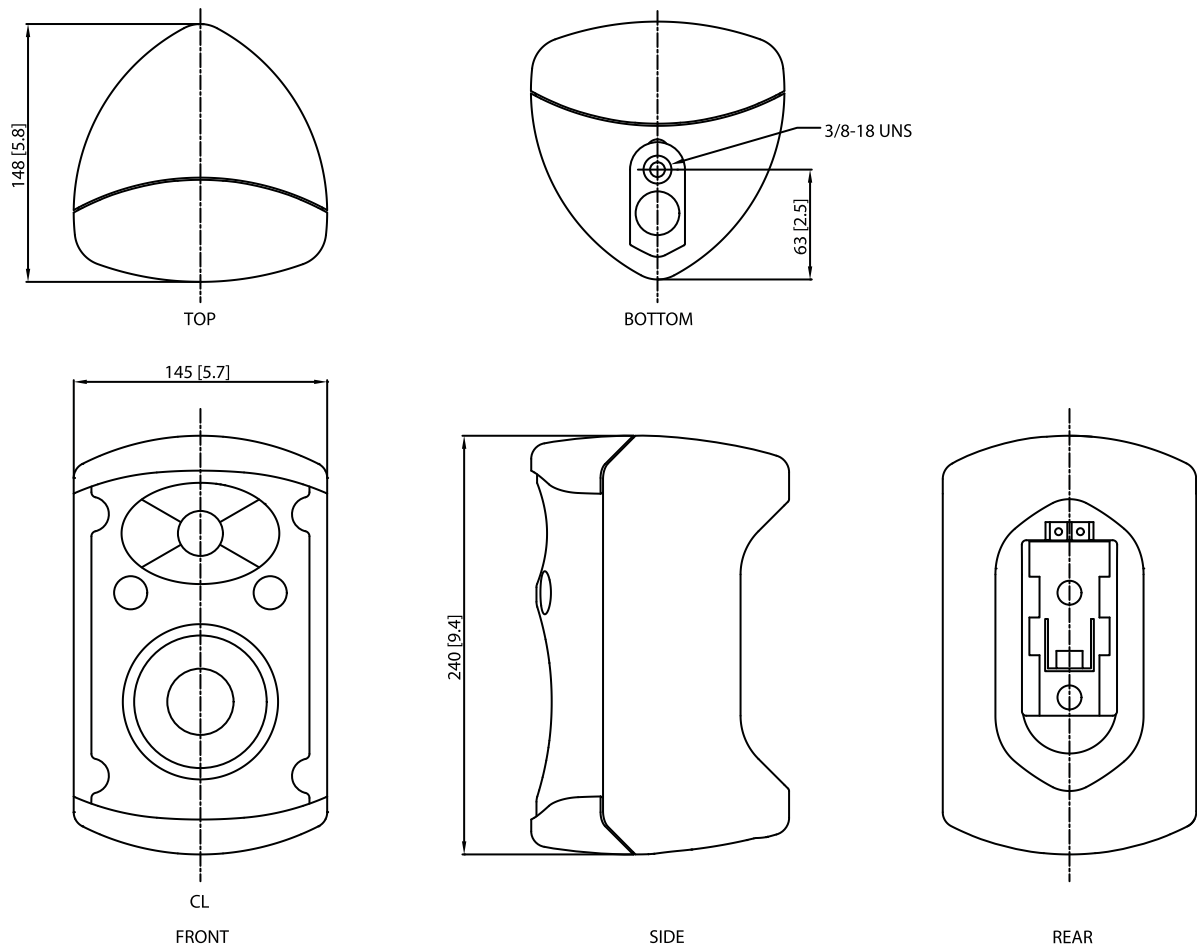

Install Speakers

IMPACT

TCI32-T-WH

Pair of 2 Way 3.5" Full Range
Loudspeakers with Line Transformers
for Installation Applications (White)

Technical Specifications

System

Frequency response	90 Hz - 20 kHz \pm 3 dB 70 Hz - 20 kHz -10 dB
Nominal dispersion	120° H x 100° V @ -6 dB points
Power handling (IEC)	
Passive	30 W continuous, 120 W peak
100 V line	30, 15, 7.5 W continuous
70 V line	30, 15, 7.5, 3.75 W continuous
Sensitivity	88 dB (1 W @ 1 m)
Maximum SPL	
Passive	103 dB continuous, 109 dB peak
100 V line	109, 106, 103 dB peak
70 V line	109, 106, 103, 100 dB peak
Impedance	16 Ω
Components	1 x 3.5" (89 mm) LF driver 1 x 1" (25 mm) HF soft dome driver

Enclosure

Connectors	Screw terminal block
Wiring	Input +VE, -VE
Dimensions HWD	240 x 145 x 148 mm (9.4 x 5.7 x 5.8")
Net weight	2.8 kg (6.2 lbs)
Construction	Gas injected, glass-filled moulded ABS enclosure
Finish	White (black optional)
Grille	Powder coated perforated steel
Flying hardware	M6 x 2 points

Accessories

Wall bracket - included

Install Speakers

IMPACT TCI32-T-WH

Pair of 2 Way 3.5" Full Range
Loudspeakers with Line Transformers
for Installation Applications (White)

Architecture & Engineering Specifications

The system shall be of the passive two-way type consisting of one 3.5" (89 mm) low frequency driver and one 1" (25 mm) ferro-fluid cooled neodymium high frequency tweeter with integral line transformer and shall be supplied with an adjustable wall bracket providing integral electrical connections. Performance specifications of a typical production unit shall meet or exceed the following: Frequency response, measured with swept sine wave input, shall be flat within ± 3 dB from 90 Hz to 20 kHz, and within -10 dB from 70 Hz to 20 kHz. Nominal dispersion, at -6 dB points, shall average 120° H x 100° V. Nominal impedance shall be 16 ohms. Power handling shall be 30 watts continuous, 120 Watts peak. Sensitivity, measured with 1 Watt input at 1 metre distance on axis, mean averaged over stated bandwidth shall be 88 dB. Maximum SPL (peak) measured with music program input at stated amplifier power shall be 109 dB. Dimensions: 240 mm high x 145 mm wide x 148 mm deep (9.5" x 5.7" x 5.8"). Net weight: 2.8 kg (6.2 lbs). The loudspeaker system shall be the **TURBOSOUND** IMPACT TCI32-T-WH. No other loudspeaker shall be acceptable unless submitted data from an independent test laboratory verifies that the above combined performance / size specifications are equalled or exceeded.

Install Speakers

IMPACT TCI32-T-WH

Pair of 2 Way 3.5" Full Range
Loudspeakers with Line Transformers
for Installation Applications (White)

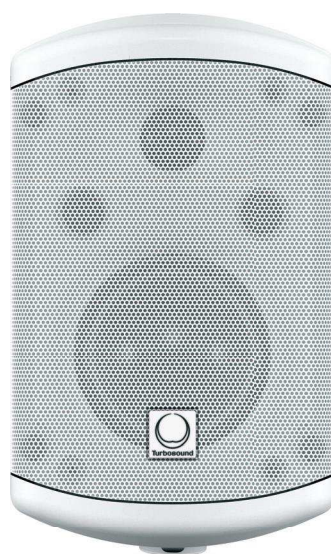

Install Speakers

IMPACT TCI32-T-WH

Pair of 2 Way 3.5" Full Range
Loudspeakers with Line Transformers
for Installation Applications (White)

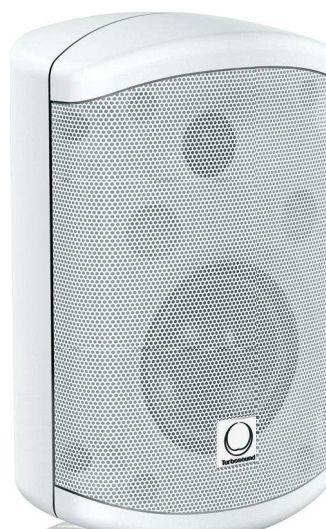
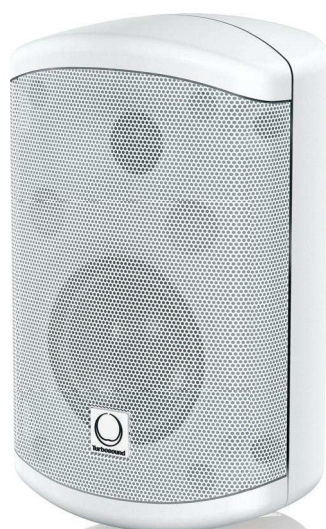

Install Speakers

IMPACT TCI32-T-WH

Pair of 2 Way 3.5" Full Range
Loudspeakers with Line Transformers
for Installation Applications (White)



For service, support or more information contact the TURBOSOUND location nearest you:

Europe
MUSIC Group Services UK
Tel: +44 156 273 2290
Email: CARE@music-group.com

USA/Canada
MUSIC Group Services NV Inc.
Tel: +1 702 800 8290
Email: CARE@music-group.com

Japan
MUSIC Group Services JP K.K.
Tel: +81 3 6231 0454
Email: CARE@music-group.com

MUSIC Group accepts no liability for any loss which may be suffered by any person who relies either wholly or in part upon any description, photograph, or statement contained herein. Technical specifications, appearances and other information are subject to change without notice. All trademarks are the property of their respective owners. MIDAS, KLARK TEKNIK, TURBOSOUND, BEHRINGER, BUGERA and DDA are trademarks or registered trademarks of MUSIC Group IP Ltd. © MUSIC Group IP Ltd. 2015 All rights reserved.

