

ART 932-A

PROFESSIONAL ACTIVE SPEAKER

DESCRIPTION

ART 932-A is masterfully engineered to deliver stellar audio performance and versatility for intensive audio applications. The combination of a 3" titanium/neodymium compression driver, 12" woofer - two-channel 2100W amplifier, and the constant directivity True Resistive Waveguide produces coherent 100° x 60° coverage for the listening area with up to 132 dB SPL, distortion-free sound. Merging RCF proprietary FiRPHASE and Bass Motion Control DSP processing, perfectly tuned for each model, the audience will experience absolute clarity and deep, powerful bass response.

The sleek cabinet uses a special polypropylene composite material with an M-brace internal reinforcement, making it easy to carry and secure to install on a pole, flown-, wall-, or truss-mounted using the multiple rigging points available.



FEATURES

- Up to 132 dB Sound Pressure Level
- 2100W Class-D Bi-Amplification
- 45-20000 Hz linear frequency response
- 3" Titanium/Neodymium Compression Driver
- 12" Woofer
- FiRPHASE zero degrees phase technology
- Bass Motion Control woofer excursion management

TECHNICAL SPECIFICATIONS

Acoustical specifications	Frequency Response:	50 Hz ÷ 20000 Hz
	Max SPL @ 1m:	132 dB
	Horizontal coverage angle:	100°
	Vertical coverage angle:	60°
Transducers	Compression Driver:	1 x 1.4" neo, 3.0" v.c
	Woofers:	12", 2.5" v.c
Input/Output section	Input signal:	bal/unbal
	Input connectors:	XLR, Jack
	Output connectors:	XLR
	Input sensitivity:	-2 dBu/+4 dBu
Processor section	Crossover Frequencies:	700Hz
	Protections:	Thermal, RMS
	Limiter:	Soft Limiter
	Controls:	Linear, Boost, Stage, Volume
Power section	Total Power:	2100 W Peak
	High frequencies:	700 W Peak
	Low frequencies:	1400 W Peak
	Cooling:	Convection
	Connections:	VDE
Standard compliance	CE marking:	Yes
Physical specifications	Cabinet/Case Material:	PP Composite
	Hardware:	1 x M10 Top, 1 x M10 each side
	Handles:	1 Top , 1 each side
	Pole mount/Cap:	Yes
	Grille:	Steel
	Color:	Black
Size	Height:	642 mm / 25.28 inches
	Width:	370 mm / 14.57 inches
	Depth:	363 mm / 14.29 inches
	Weight:	18.8 kg / 41.45 lbs
Shipping informations	Package Height:	685 mm / 26.97 inches
	Package Width:	430 mm / 16.93 inches
	Package Depth:	423 mm / 16.65 inches
	Package Weight:	21 kg / 46.3 lbs



PART NUMBER

- **13000681**
ART 932-A
115V
EAN 8024530019266

- **13000680**
ART 932-A
220-240V
EAN 8024530019112

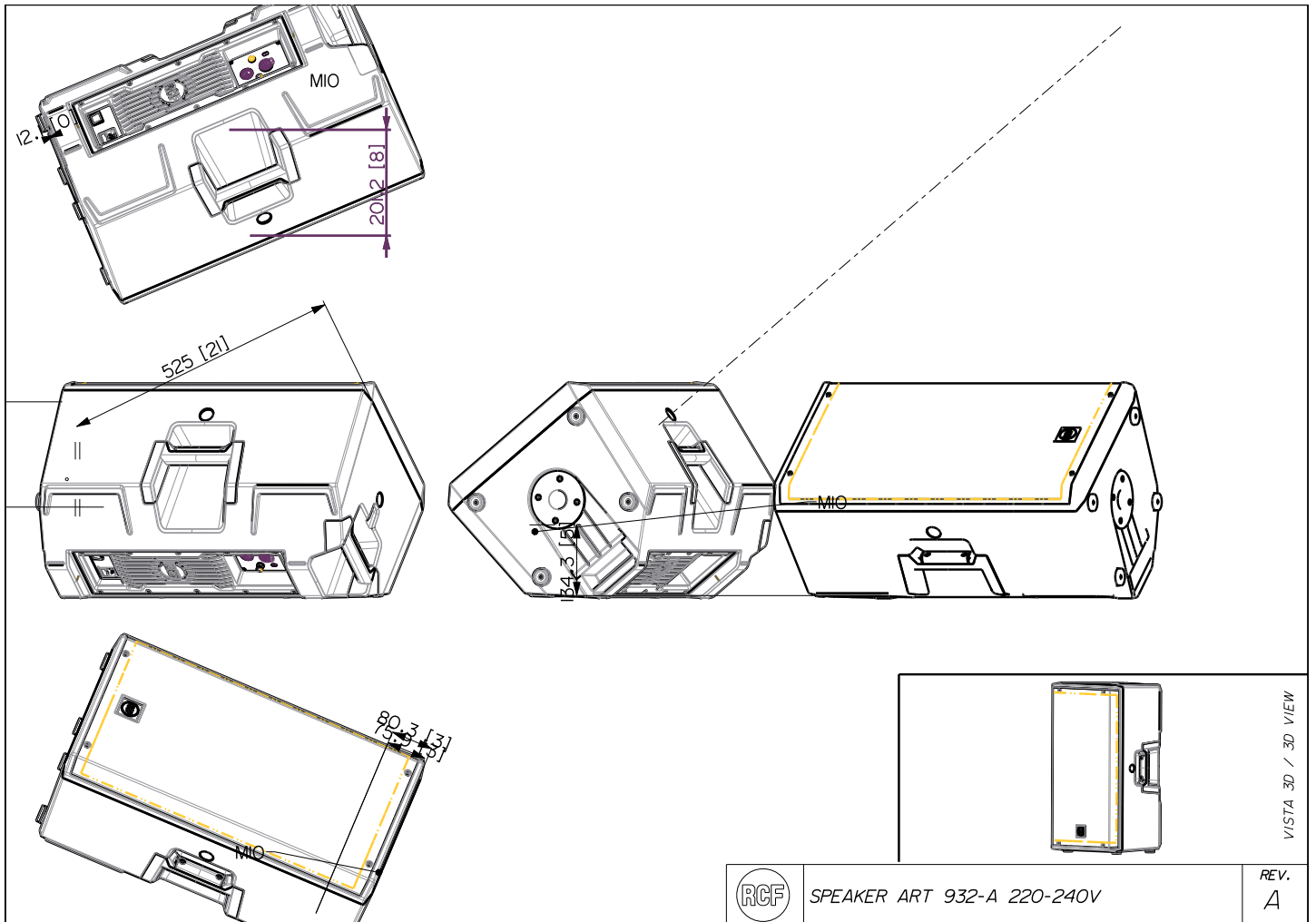

SPEAKER ART 932-A 220-240V

REV.
A

VISTA 3D / 3D VIEW

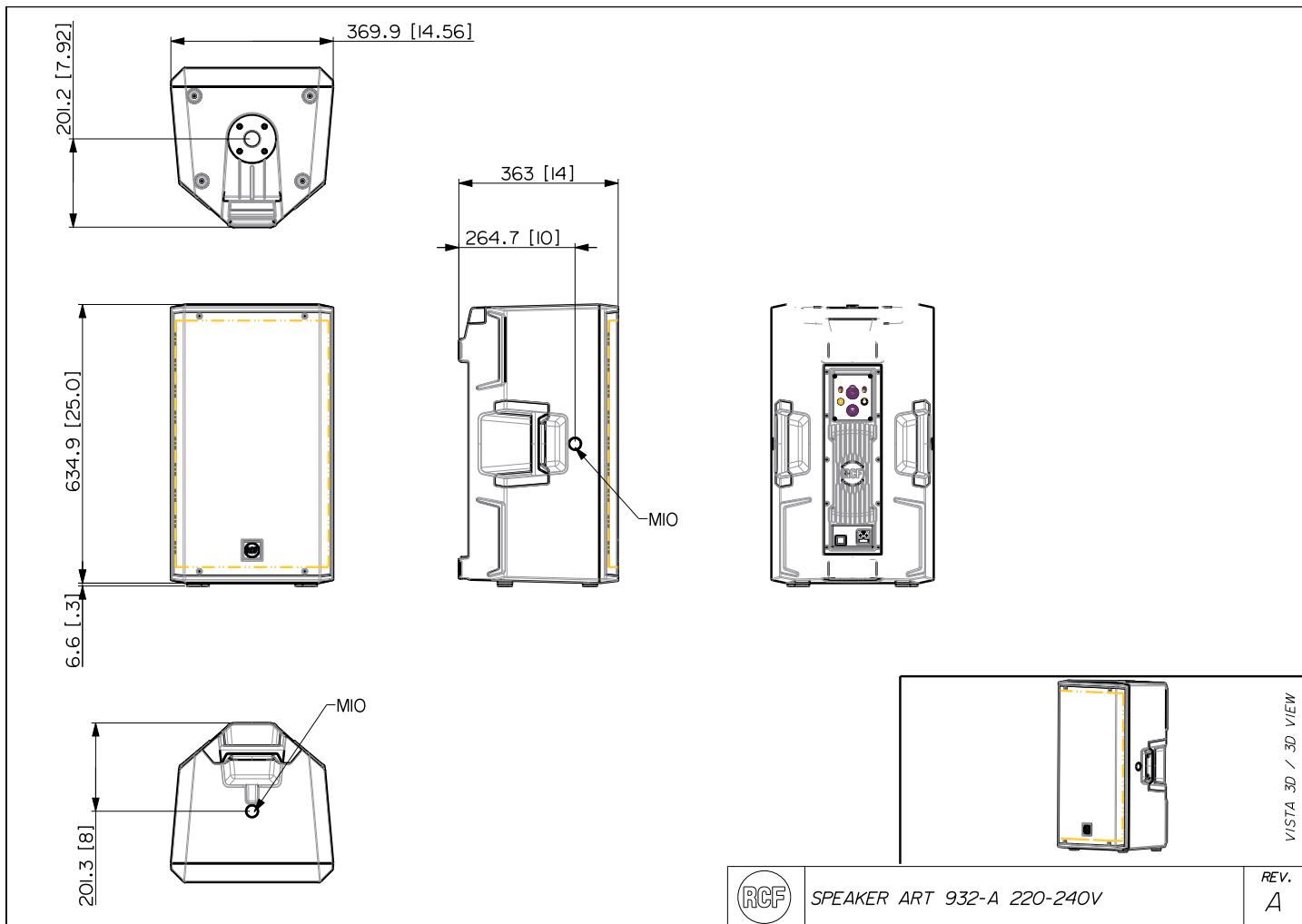

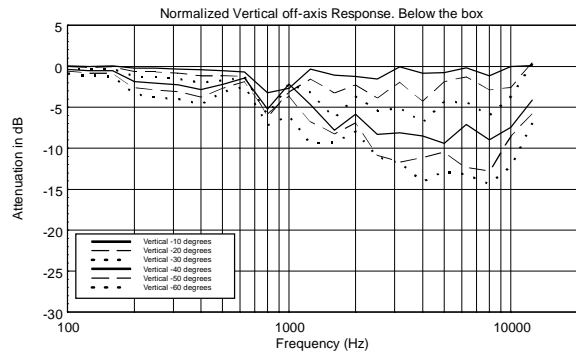
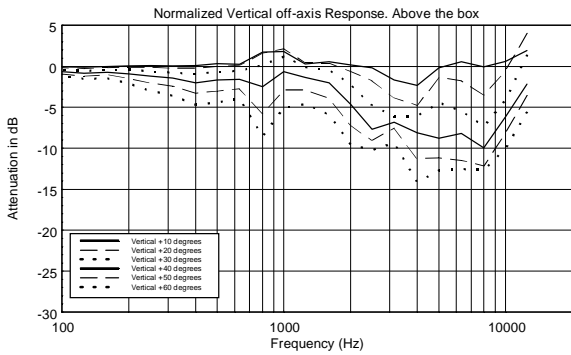
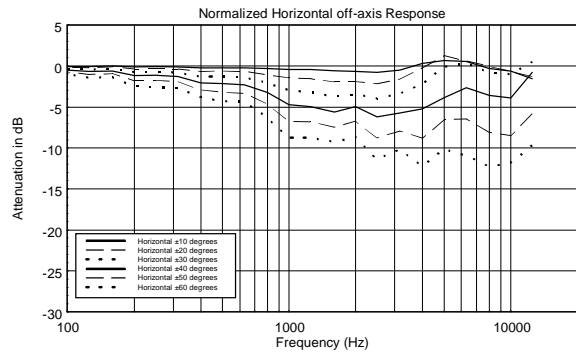
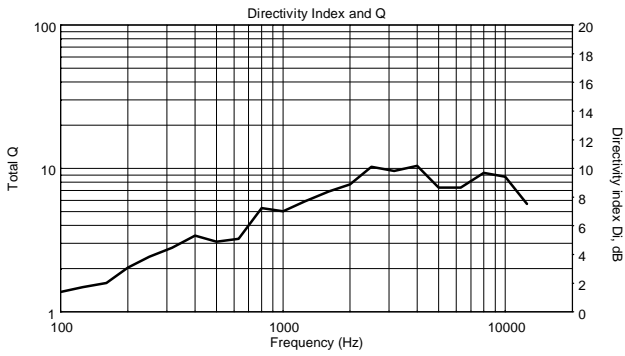
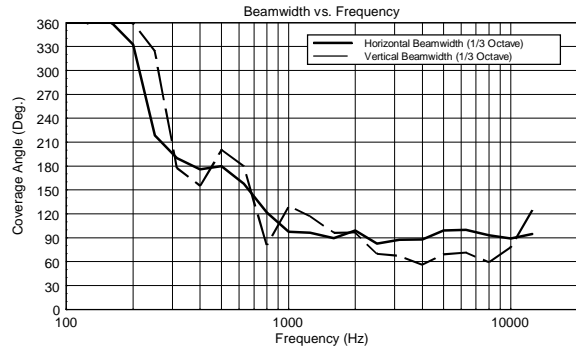
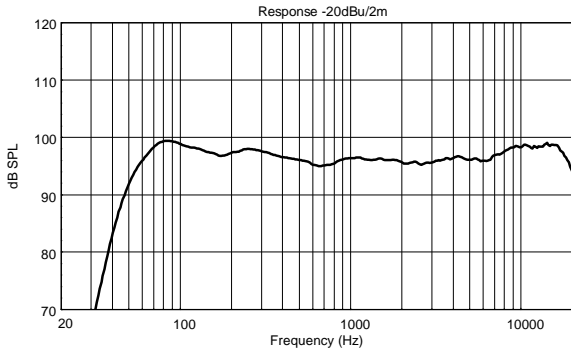

Horizontal 1/3 Octave Polars

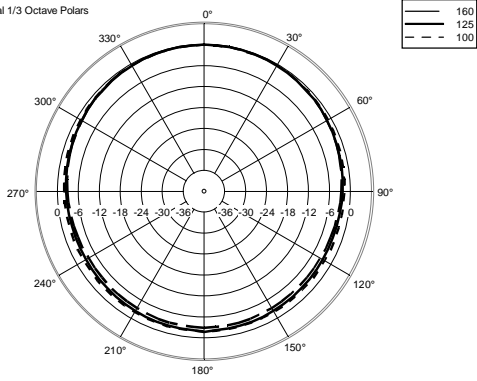

Horizontal 1/3 Octave Polars

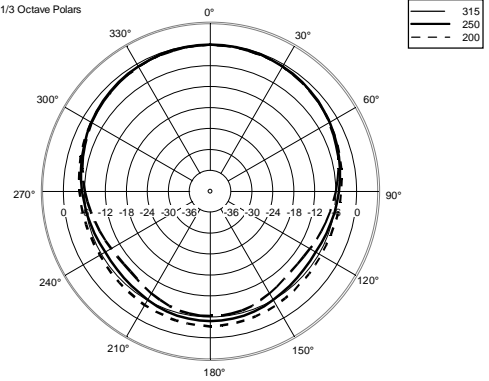

Horizontal 1/3 Octave Polars

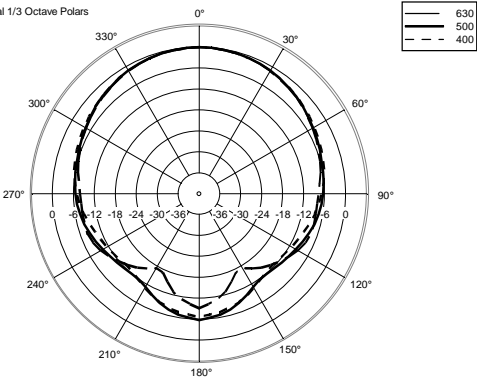

Horizontal 1/3 Octave Polars

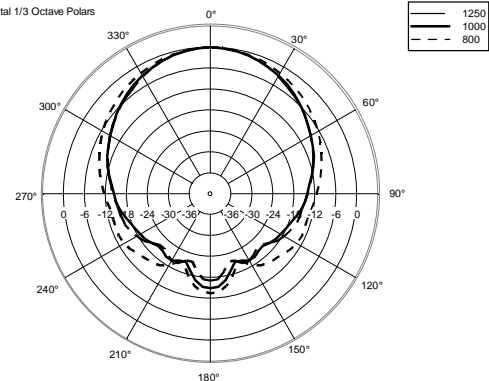

Horizontal 1/3 Octave Polars

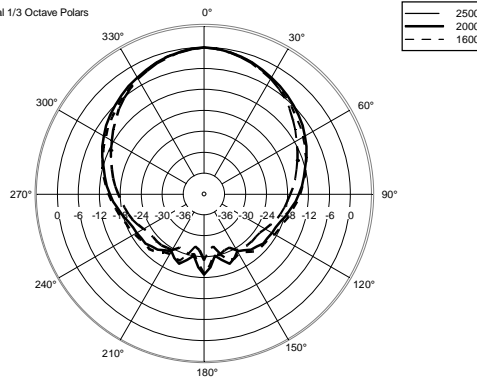

Horizontal 1/3 Octave Polars

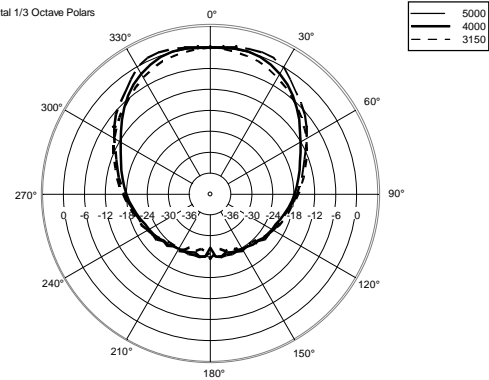

Horizontal 1/3 Octave Polars

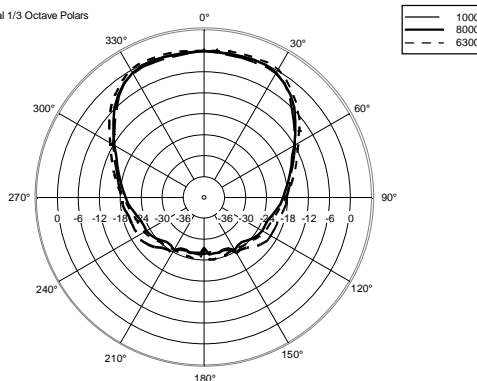



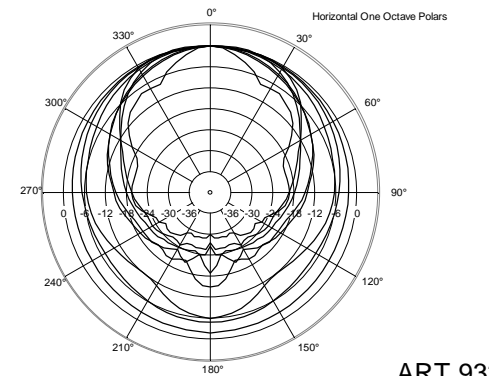

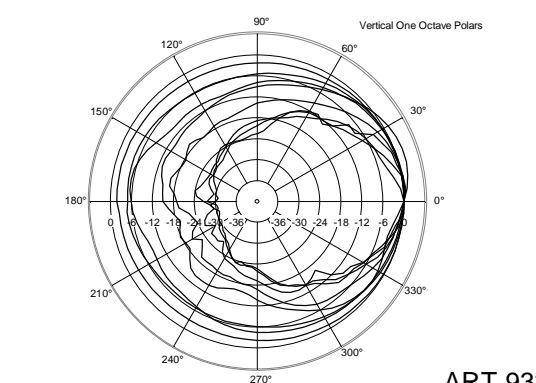
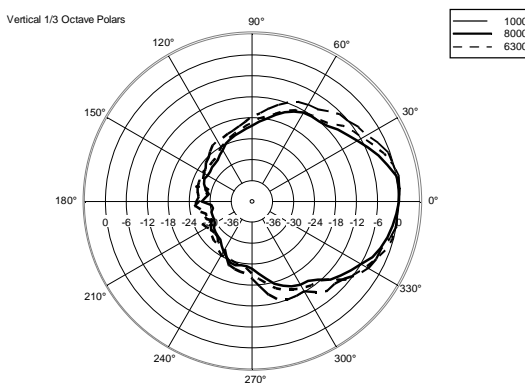
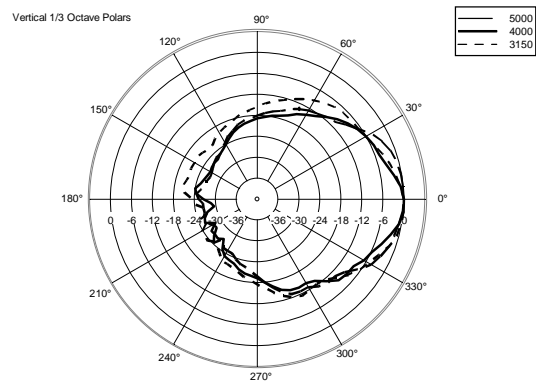
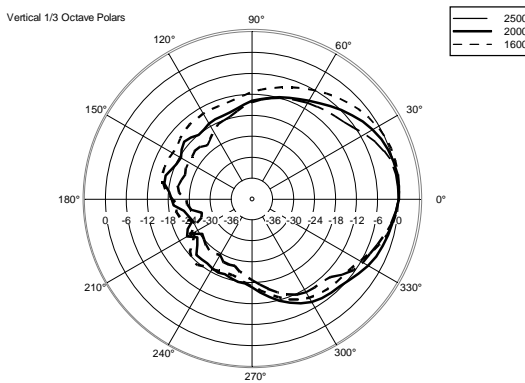
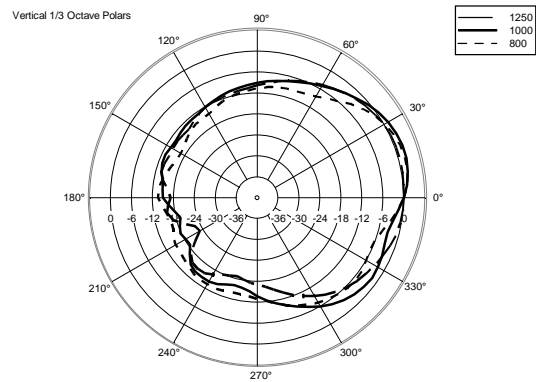
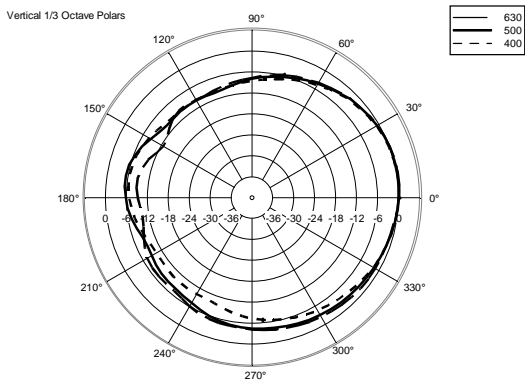
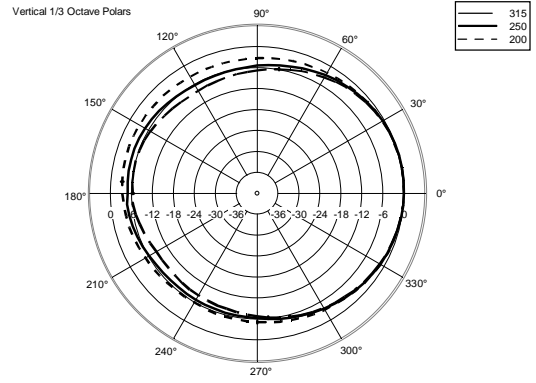
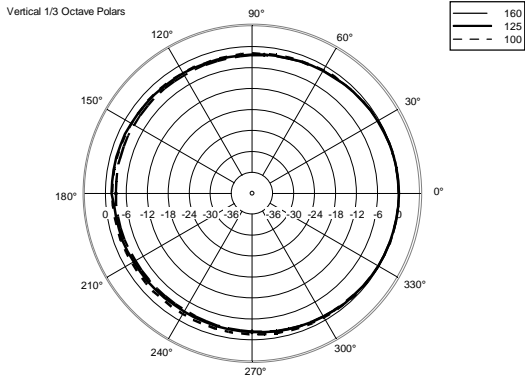



Horizontal One Octave Polars





ACCESSORIES

	AC PMA - POLE MOUNT	PART NUMBER EAN:	13360034 8024530007713
	AC PM-M20	PART NUMBER EAN:	13360067 8024530014599
	AC PMX POLE MOUNT M20	PART NUMBER EAN:	13360232 8024530010058
	AC PRO-FS PROFESS. LOCKING FLOOR STAND	PART NUMBER EAN:	13360109 8024530006471
	AC PRO-PM PROFESS. LOCKING POLE MOUNT	PART NUMBER EAN:	13360110 8024530006488
	COVER CVR ART 912	PART NUMBER EAN:	13360474 8024530018849
	FLYING BRACKET FL-BR ART 912	PART NUMBER EAN:	13360477 8024530019204
	HORIZONTAL BRACKET H-BR ART 912	PART NUMBER EAN:	13360475 8024530019228
	VERTICAL BRACKET V-BR ART 912	PART NUMBER EAN:	13360476 8024530019211