

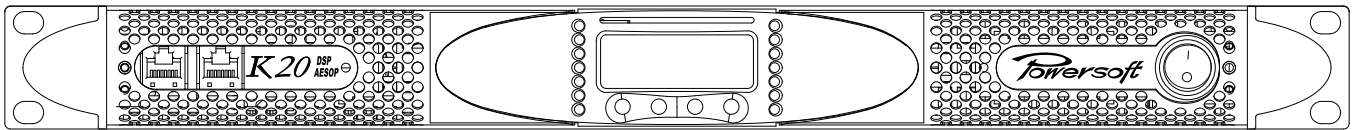

K Series

Top class amplification covering
any power needs in touring applications

K2, K3
K6, K8, K10, K20
and DSP + AESOP versions



USER GUIDE

powersoft_KSeries_uguide_mul_v3.0

Data are subject to change without notice.
For latest update please refer to the
online version available on www.powersoft-audio.com.

K Series | User Guide

English

1.Important safety instructions	1
2.Regulatory information	2
3.K Series	3
3:1.Welcome	3
3:4.About the amplifier platform	3
3:2.Unpacking & checking for shipping damage	3
3:3.Disposal of the packing material	3
4.Installation	4
4:1.Cooling	4
4:2.Cleaning	4
4:3.AC mains supply	5
4:4.Precautions regarding installation	5
5.Connections	6
5:1.Signal grounding	6
5:2.Analog input	6
5:3.Analog line output	6
5:4.Digital Input	6
5:5.AESOP	6
5:6.Loudspeaker connections	7
5:6.1.Bridge-tied load	7
5:7.V Ext	7
5:8.RS-485 connection	7
6.LEDs and display menu	8
6:1.LED chart	8
6:2.Front display	8
6:2.1.How to navigate the main menu	8
6:2.2.Menu diagrams	9
7.Warranty and assistance	10
7:1.Warranty	10
7:1.1.Product warranty	10
7:1.2.Return of Goods	10
7:1.3.Repair or replacement	10
7:1.4.Cost and responsibility of transport	10
7:2.Assistance	10

Française

1.Importantes instructions de sécurité	11
---	-----------

A

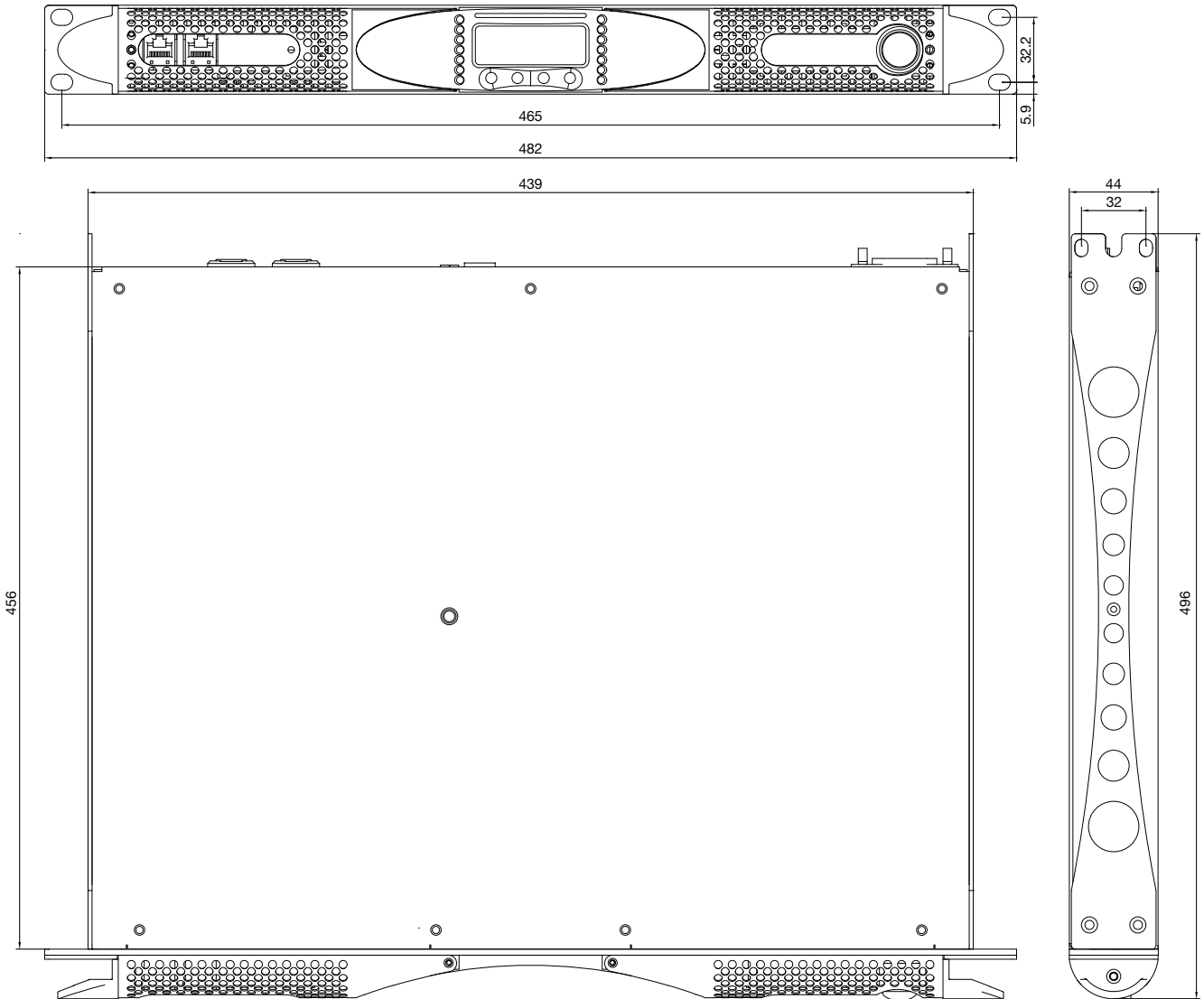

B

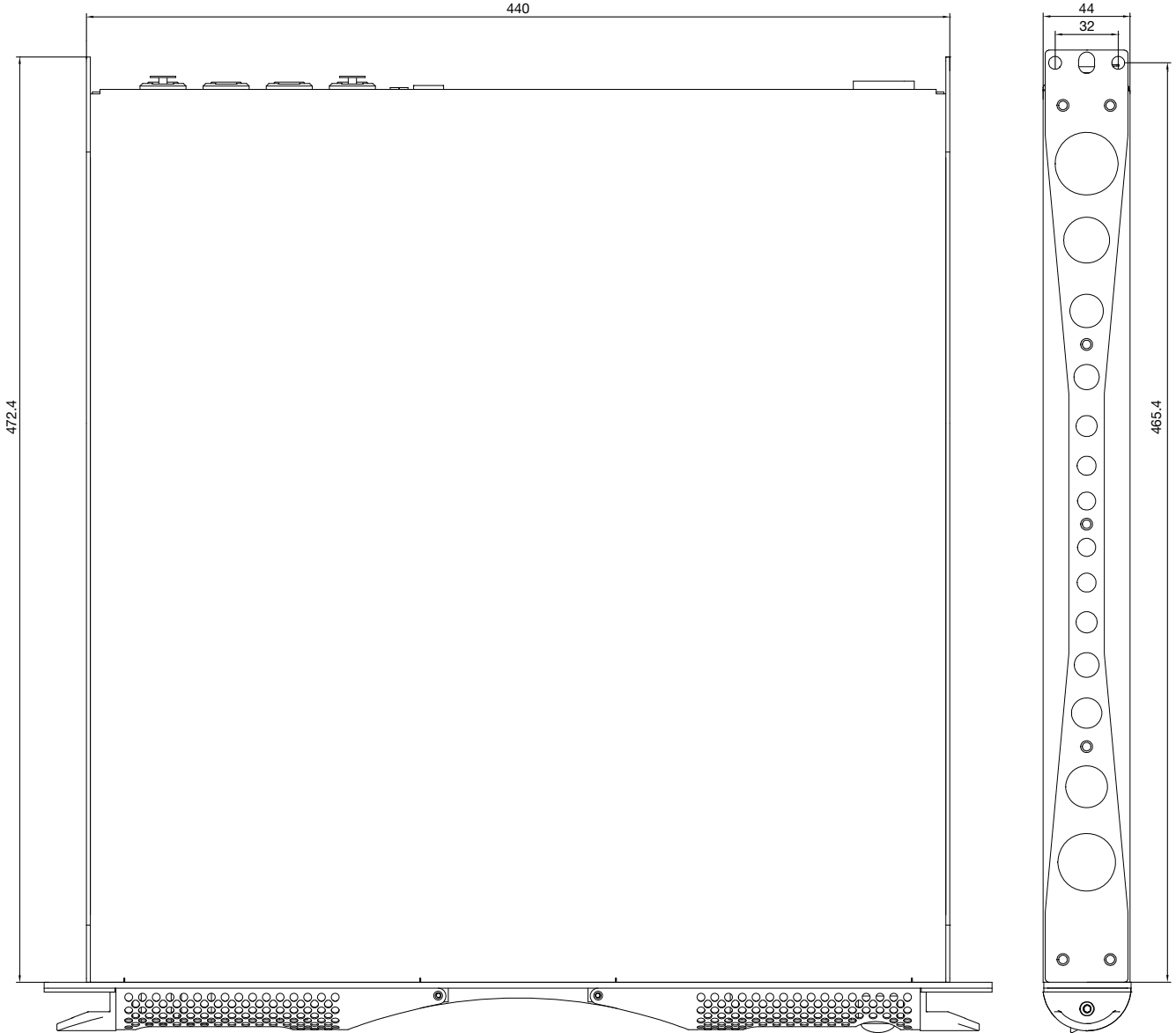
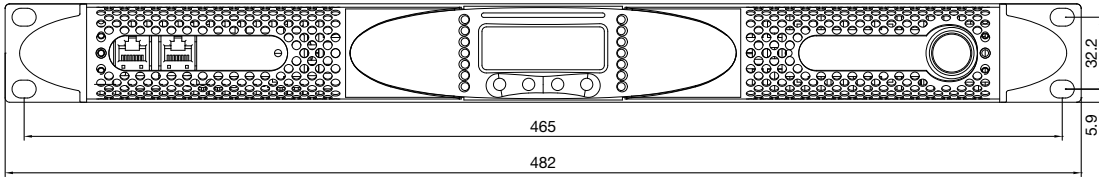

C

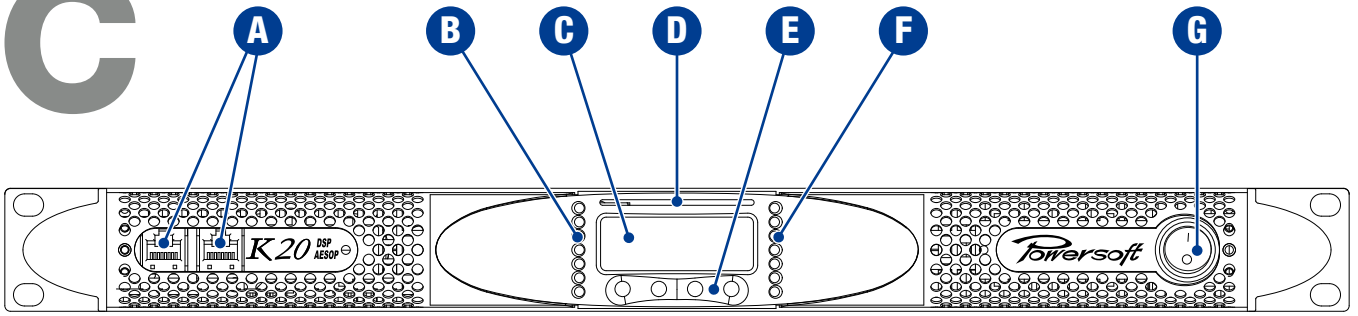

D

K2, K3

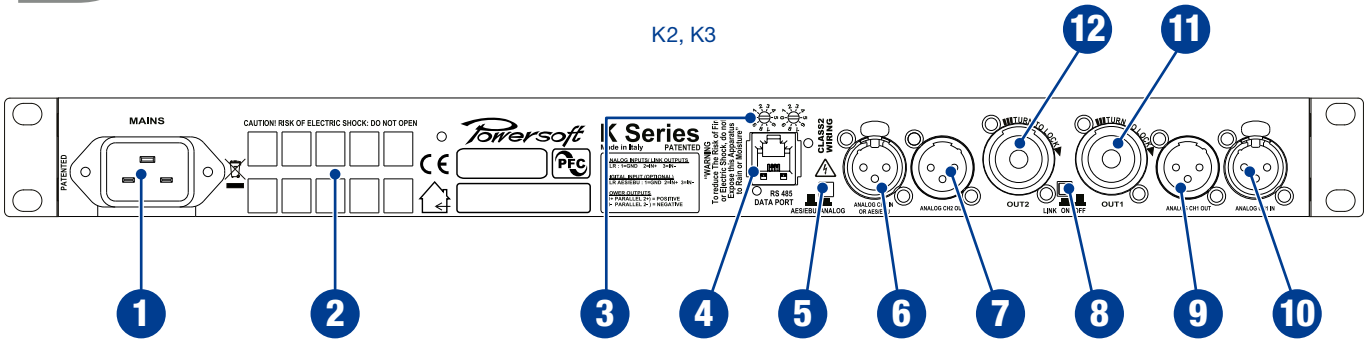

E

K2, K3 AESOP

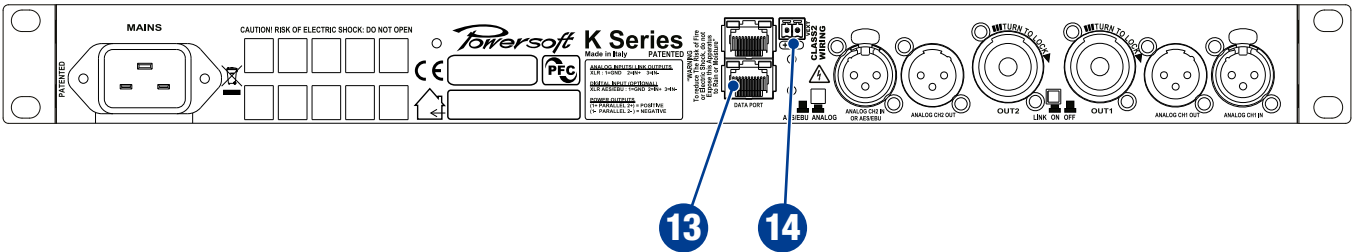

English

- A. RJ45 plugs (either AESOP or RS485 ports according to the amplifier configuration)
- B. LED bar: signal metering channel 1
- C. Main display
- D. Smart Card slot
- E. Multifunction buttons
- F. LED bar: signal metering channel 2
- G. Main switch

- 1. Mains plug
- 2. Air vents
- 3. Serial ID selector for the RS485 port (non AESOP version only)
- 4. RS485 serial port (non AESOP version only)
- 5. AES3/analog switch for input 2
- 6. Input 2: channel 2 analog input in analog mode or AES3 input in AES3 mode, according to the position of the switch in #5
- 7. Line output channel 2
- 8. Link button: link input from channels 1 and 2
- 9. Line output channel 1
- 10. Input 1: channel 1 analog input
- 11. Speaker connector: output channel 1
- 12. Speaker connector: output channel 2
- 13. Ethernet+AESOP ports (AESOP version only)
- 14. Vext: 12 V_{DC}, 1A external voltage input (AESOP version only)

Française

- A.
- B.
- C.
- D.
- E.
- F.
- G.

- 1.
- 2.
- 3.
- 4.
- 5.
- 6.
- 7.
- 8.
- 9.
- 10.
- 11.
- 12.
- 13.
- 14.

Español

- A.
- B.
- C.
- D.
- E.
- F.
- G.

- 1.
- 2.
- 3.
- 4.
- 5.
- 6.
- 7.
- 8.
- 9.
- 10.
- 11.
- 12.
- 13.
- 14.

Italiano

- A.
- B.
- C.
- D.
- E.
- F.
- G.

- 1.
- 2.
- 3.
- 4.
- 5.
- 6.
- 7.
- 8.
- 9.
- 10.
- 11.
- 12.
- 13.
- 14.

F

K6, K8, K10, K20

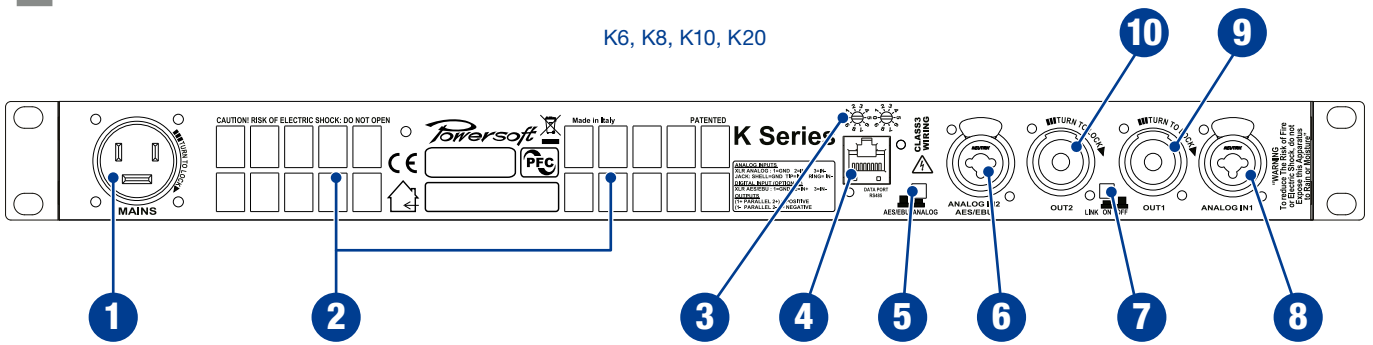

G

K6, K8, K10, K20 AESOP

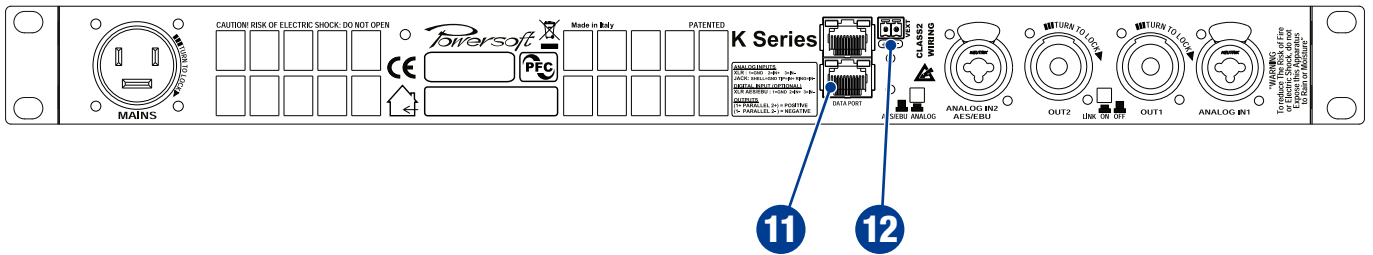

English

1. Mains plug
2. Air vents
3. Serial ID selector for the RS485 port (non AESOP version only)
4. RS485 serial port (non AESOP version only)
5. AES3/analog switch for input 2
6. Input 2: channel 2 analog input in analog mode or AES3 input in AES3 mode, according to the position of the switch in #5
7. Link button: link input from channels 1 and 2
8. Input 1: channel 1 analog input
9. Speaker connector: output channel 1
10. Speaker connector: output channel 2
11. Ethernet+AESOP ports (AESOP version only)
12. Vext: 12 V_{DC}, 1A external voltage input (AESOP version only)

Française

- 1.
- 2.
- 3.
- 4.
- 5.
- 6.
- 7.
- 8.
- 9.
- 10.
- 11.
- 12.

Español

- 1.
- 2.
- 3.
- 4.
- 5.
- 6.
- 7.
- 8.
- 9.
- 10.
- 11.
- 12.

Italiano

- 1.
- 2.
- 3.
- 4.
- 5.
- 6.
- 7.
- 8.
- 9.
- 10.
- 11.
- 12.

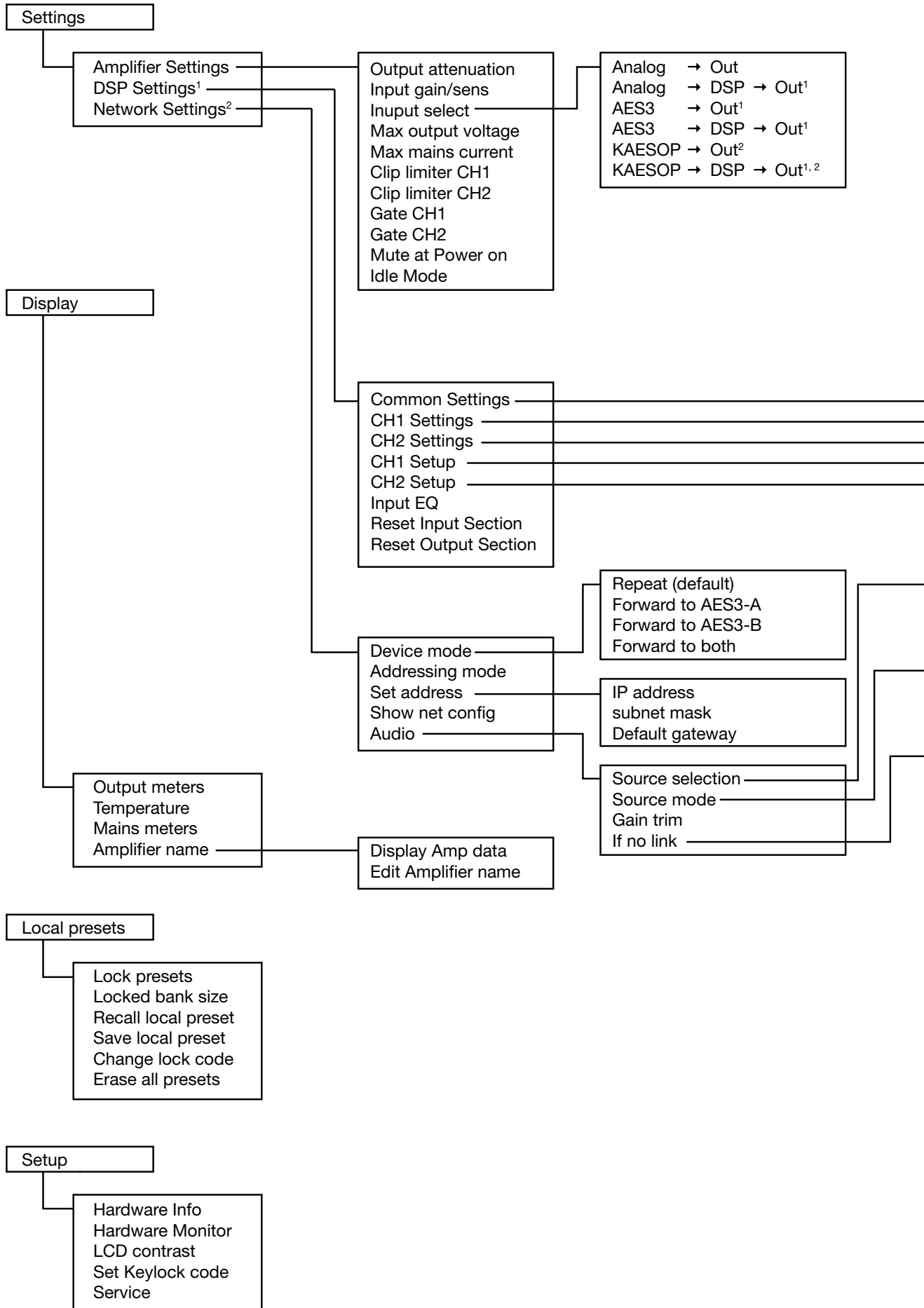

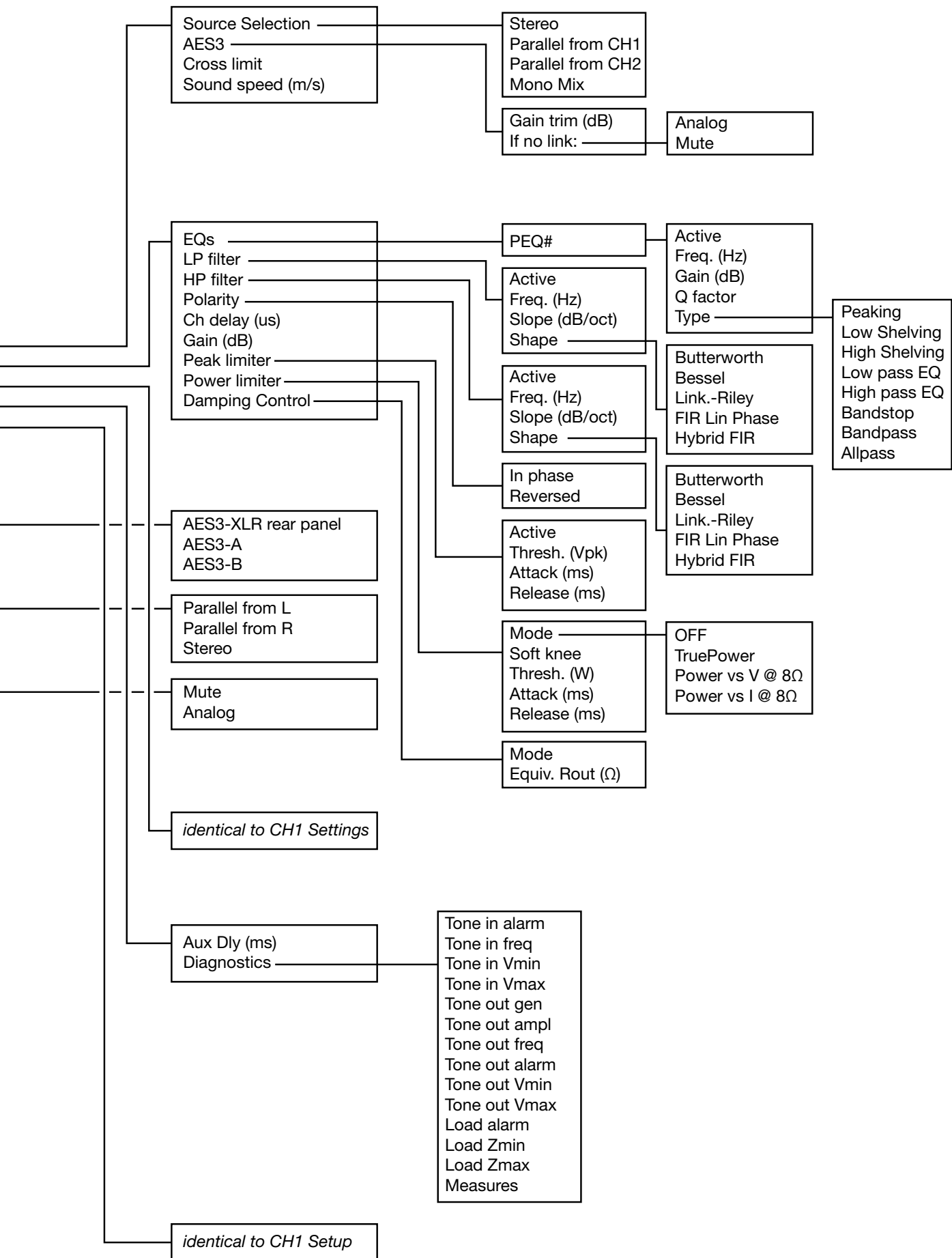

¹ Available only with optional KDSP board

² Available only with optional KAESOP board

I

Analog input XLR-M pinout

Pin 1	GND
Pin 2	HOT ⊕
Pin 3	COLD ⊖

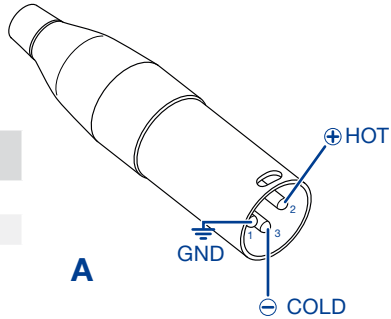

Analog input TRS Jack pinout

Tip	HOT ⊕
Ring	COLD ⊖
Sleeve	GND

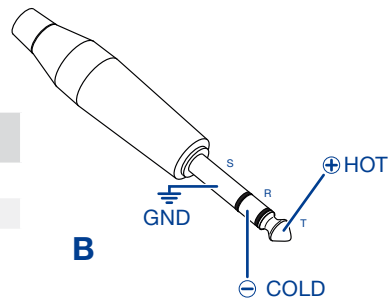

Analog line output XLR-F pinout

Pin 1	GND
Pin 2	HOT ⊕
Pin 3	COLD ⊖

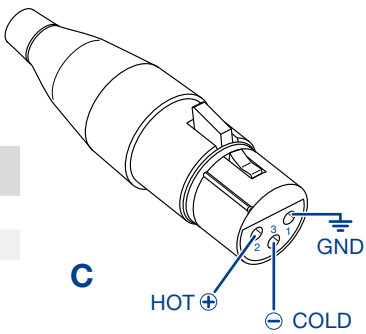

J

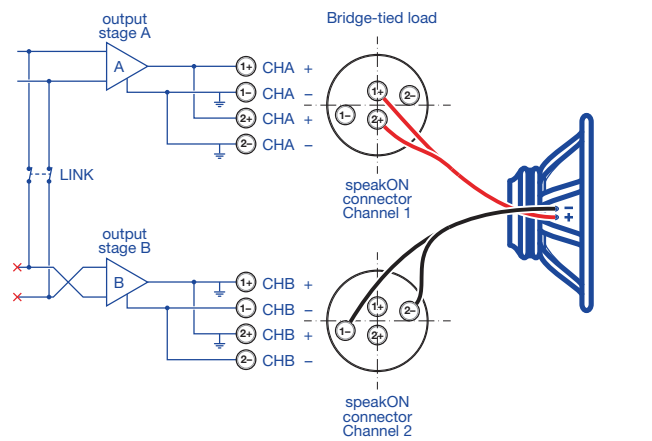
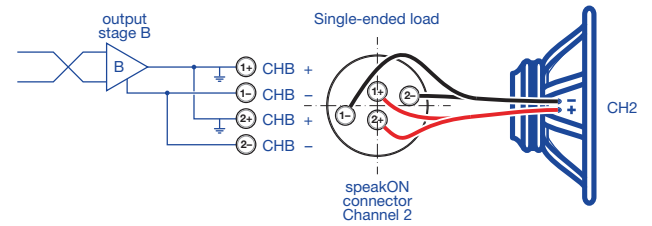
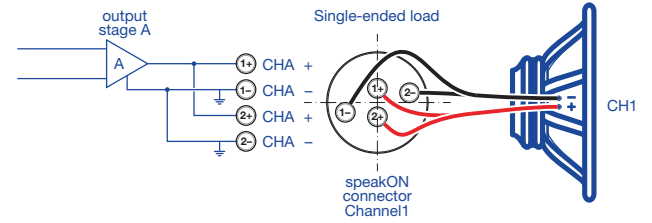

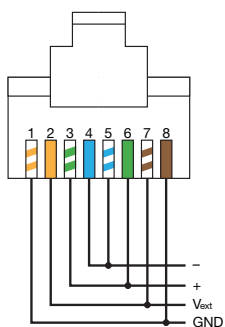

K





Important safety instructions

EXPLANATIONS OF GRAPHICAL SYMBOLS

 The triangle with the lightning bolt is used to alert the user to the risk of electric shock.

 The triangle with the exclamation point is used to alert the user to important operating or maintenance instructions.

 The CE-mark indicates the compliance with the low voltage and electromagnetic compatibility.

 Symbol for earth/ground connection.

 Symbol indicating that the equipment is for indoor use only.

 Symbol for conformity with Directive 2002/96/EC and Directive 2003/108/EC of the European Parliament on waste electrical and electronic equipment (WEEE).

 **WARNING: TO REDUCE THE RISK OF ELECTRIC SHOCK, DO NOT ATTEMPT TO OPEN ANY PART OF THE UNIT. NO USER-SERVICEABLE PARTS INSIDE. REFER SERVICING TO QUALIFIED SERVICE PERSONNEL.**

 **TO COMPLETELY DISCONNECT THIS APPARATUS FROM THE AC MAINS, DISCONNECT THE POWER SUPPLY CORD PLUG FROM THE AC RECEPTACLE.***

 **THE MAINS PLUG OF THE POWER SUPPLY CORD MUST REMAIN READILY ACCESSIBLE.****

 **DO NOT EXPOSE THIS EQUIPMENT TO RAIN OR MOISTURE, DRIPPING OR SPLASHING LIQUIDS. OBJECTS FILLED WITH LIQUIDS, SUCH AS VASES, SHOULD NOT BE PLACED ON THIS APPARATUS.**

 **K6, K8, K10 AND K20 MUST BE INSTALLED IN RACK CABINETS: INSTEAD OF CONNECTING THE AMPLIFIER TO THE POWER GRID DIRECTLY, PLUG THE AMPLIFIER'S MAINS CONNECTIONS VIA A SECTIONING BREAKER TO A POWER DISTRIBUTION PANEL INSIDE THE RACK CABINET.**

 **WHEN THE UNIT IS INSTALLED IN A CABINET OR A SHELF, MAKE SURE THAT IT HAS SUFFICIENT SPACE ON ALL SIDES TO ALLOW FOR PROPER VENTILATION (50 CM FROM THE FRONT AND REAR VENTILATION OPENINGS).**

 **CONNECTION TO THE MAINS SHALL BE DONE ONLY BY A ELECTROTECHNICAL SKILLED PERSON ACCORDING THE NATIONAL REQUIREMENTS OF THE COUNTRIES WHERE THE UNIT IS SOLD.**



Electrical energy can perform many useful functions. This unit has been engineered and manufactured to ensure your personal safety. But IMPROPER USE CAN RESULT IN POTENTIAL ELECTRICAL SHOCK OR FIRE HAZARD.

In order not to defeat the safeguards incorporated into this product, observe the following basic rules for its installation, use and service. Please read these "Important Safeguards" carefully before use.

Important safety instructions

1. Read these instructions.
2. Keep these instructions.
3. Heed all warnings.
4. Follow all instructions.
5. Do not use this equipment near water.
6. Clean only with a dry cloth.
7. Do not block any ventilation openings. Install in accordance with the manufacturer's instructions.
8. Do not install near any heat sources such as radiators, heat registers, stoves, or other apparatus (including amplifiers) that produce heat.
9. Do not defeat the safety purpose of the polarized or grounding-type plug. A polarized plug has two blades with one wider than the other. A grounding type plug has two blades and a third grounding prong. The wide blade or the third prong are provided for your safety. If the provided plug does not fit into your outlet, consult an electrician for replacement of the obsolete outlet.
10. Protect the power cord from being walked on or pinched particularly at plugs, convenience receptacles, and the point where they exit from the apparatus.
11. Only use attachments/accessories specified by the manufacturer.
12. Use only with the cart, stand, tripod, bracket, or table specified by the manufacturer, or sold with the apparatus. When a cart is used, use caution when moving the cart/apparatus combination to avoid injury from tip-over.
13. Unplug this apparatus during lightning storms or when unused for long periods of time.
14. Refer all servicing to qualified service personnel. Servicing is required when the apparatus has been damaged in any way, such as power-supply cord or plug is damaged, liquid has been spilled or objects have fallen into the apparatus, the apparatus has been exposed to rain or moisture, does not operate normally, or has been dropped.



Numbers 9 and 13 apply only to K2 and K3.

* K6, K8, K10 and K20: interrupt the mains by switching the sectioning breaker off.

** Valid for K2 and K3 model only; with K6, K8, K10 and K20 a free leads power cord (i.e. without plug) is provided: this solution is intended for connecting the device to a sectioning breaker on the mains. Refer to the installation instruction for selecting the proper sectioning breaker.

Regulatory information

2

FCC COMPLIANCE NOTICE

This device complies with part 15 of the FCC rules. Operation is subject to the following two conditions: (1) This device may not cause harmful interference, and (2) this device must accept any interference received, including interference that may cause undesired operation.

CAUTION: Changes or modifications not expressly approved by the party responsible for compliance could void the user's authority to operate the equipment.

NOTE: This equipment has been tested and found to comply with the limits for a Class B digital device, pursuant to part 15 of the FCC Rules. These limits are designed to provide reasonable protection against harmful interference in a residential installation. This equipment generates, uses, and can radiate radio frequency energy and, if not installed and used in accordance with the instruction manual, may cause harmful interference to radio communications. However, there is no guarantee that interference will not occur in a particular installation. If this equipment does cause harmful interference to radio or television reception, which can be determined by turning the equipment off and on, the user is encouraged to try to correct the interference by one or more of the following measures:

- ▶ Reorient or relocate the receiving antenna.
- ▶ Increase the separation between the equipment and receiver.
- ▶ Connect the equipment into an outlet on a circuit different from that to which the receiver is connected.
- ▶ Consult the dealer or an experienced radio/TV technician for help.

WEEE DIRECTIVE

If the time arises to throw away your product, please recycle all the components possible.



This symbol indicates that when the end-user wishes to discard this product, it must be sent to separate collection facilities for recovery and recycling. By separating this product from other household-type waste, the volume of waste sent to incinerators or land-fills will be reduced and natural resources will thus be conserved.

The Waste Electrical and Electronic Equipment Directive (WEEE Directive) aims to minimise the impact of electrical and electronic goods on the environment. Powersoft S.p.A. comply with the Directive 2002/96/EC and 2003/108/EC of the European Parliament on waste electrical and electronic equipment (WEEE) in order to reduce the amount of WEEE that is being disposed of in land-fill site. All of our products are marked with the WEEE symbol; this indicates that this product must NOT be disposed of with other waste. Instead it is the user's responsibility to dispose of their waste electrical and electronic equipment by handing it over to an approved reprocessor, or by returning it to Powersoft S.p.A. for reprocessing. For more information about where you can send your waste equipment for recycling, please contact Powersoft S.p.a. or one of your local distributors.

EC DECLARATION OF CONFORMITY

Manufacturer:
Powersoft S.p.A.
via E. Conti 5
50018 Scandicci (Fi)
Italy



We declare that under our sole responsibility the products:

Model Names: K2, K3, K6, K8, K10, K20
K2 DSP+AESOP, K3 DSP+AESOP,
K6 DSP+AESOP, K8 DSP+AESOP, K10 DSP+AESOP,
K20 DSP+AESOP.

Intended use: Professional Audio Amplifier

Are in conformity with the provisions of the following EC Directives, including all amendments, and with national legislation implementing these directives:

- ▶ 2006/95/EC Low Voltage Directive
- ▶ 2004/108/EC Electromagnetic Compatibility Directive
- ▶ 2002/95/CE RoHS Directive

The following armonized standards are applied:

- ▷ EN 55103-1:2009 /A1:2012
- ▷ EN 55014-1:2006 /A1:2009 /A2:2011
- ▷ EN 55022:2010 /AC:2011
- ▷ EN 61000-3-2:2006 /A1:2009 /A2: 2009
- ▷ EN 61000-3-3:2013
- ▷ EN 61000-3-11:2000
- ▷ EN 61000-3-12:2011
- ▷ EN 55103-2:2009 /IS:2012
- ▷ EN 61000-4-2:2009
- ▷ EN 61000-4-3:2006 /A1:2008 /IS1:2009 /A2:2010
- ▷ EN 61000-4-4:2012
- ▷ EN 61000-4-5:2006
- ▷ EN 61000-4-6:2014
- ▷ EN 61000-4-11:2004
- ▷ EN 60065:2002 /A1:2006 /A11:2008 /A2:2010 /A12:2011

Scandicci,
15 July 2014

Luca Lastrucci
Managing Director

For compliance questions only: compliance@powersoft.it

3:1.Welcome

Congratulations on buying a Powersoft K Series amplifier! We know you are eager to use your new amplifier, but please take a moment to read this user's manual and safety instructions. In case you have any questions, please do not hesitate to contact your dealer or Powersoft.

Powersoft is a leading company in the field of high efficiency audio power management. The Powersoft switching mode technology has changed the way the world looks at professional audio amplification: no other amplifier's performance comes close for applications demanding high power and long term reliability. Thanks to amazing reductions in heat output and weight, without sacrificing output powers, Powersoft amplifiers can be used in an unlimited range of PA applications such as opera houses, theaters, churches, cinema, and theme parks.

3:4.About the amplifier platform

K Series has many advanced features, digital control of many parameters, adjustable maximum mains consumption, selectable digital presets and a graphic display that shows detailed information of the status of the amplifier. All K Series amplifiers come with built in Power Factor Correction. This unique feature ensures that a predominantly resistive load is presented to mains thus minimizing current distortion and voltage/current displacement. This leads to improved performance of the amplifier at high levels of output and avoids mains-voltage collapses, typical of standard and switching power supplies. Another great advantage of this technology is that its performance is, to a large extent, independent of mains voltage. The rated output power does not vary with load/line conditions.

3:2.Unpacking & checking for shipping damage

Your Powersoft product has been completely tested and inspected before leaving the factory. Carefully inspect the shipping package before opening it, and then immediately inspect your new product. If you find any damage notify the shipping company immediately.

The box contains the following:

- ▶ One K Series amplifier.
- ▶ One AC mains power cord
- ▶ This user guide.

3:3.Disposal of the packing material

The transport and protective packing has been selected from materials which are environmentally friendly for disposal and can normally be recycled.

Rather than just throwing these materials away, please ensure they are offered for recycling.

Installation

4

The common installation of the amplifier is in rack cabinets: in order to limit the risk of mechanical damages, the amplifiers must be fixed to the rack using both frontal and rear mounting brackets.

Note: Instead of connecting the amplifier to the power grid directly, plug the amplifier's mains connections to a power distribution panel inside the rack cabinet.

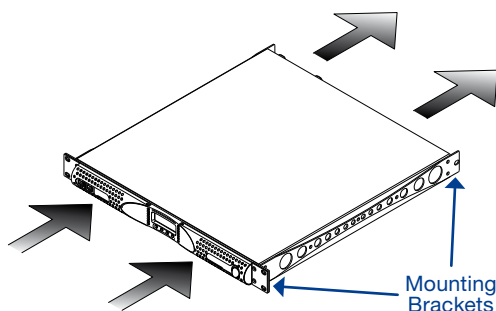

FIGURE 1: Mounting brackets and air flow direction.

4:1.Cooling

Install the amplifier in a well-ventilated location: the ventilation openings must not be impeded by any item such as newspapers, tablecloths, curtains, etc; keep a distance of at least 50 cm from the front and rear ventilation openings of the amplifier.

All Powersoft amplifiers implement a forced-air cooling system to maintain low and constant operating temperatures. Drawn by the internal fans, air enters from the front panel and is forced over all components, exiting at the back of the amplifier.

The amplifier's cooling system features "intelligent" variable-speed DC fans which are controlled by the heatsink temperature sensing circuits: the fans speed will increase only when the temperature detected by the sensors rises over carefully predetermined values. This ensures that fan noise and internal dust accumulation are kept to a strict minimum.

Should however the amplifier be subject to an extreme thermal load, the fan will force a very large volume of air through the heat sink. In the extremely rare event that the amplifier should dangerously overheat, sensing circuits shut down all channels until the amplifier cools down to a safe operating temperature. Normal operation is resumed automatically without the need for user intervention.

X Series amplifiers can be stacked one on top of the other due to the efficient cooling system they are equipped with.

There is however a safety limit to be observed: in case a rack with closed back panels is used, leave one rack unit empty every four installed amplifiers to guarantee adequate air flow.

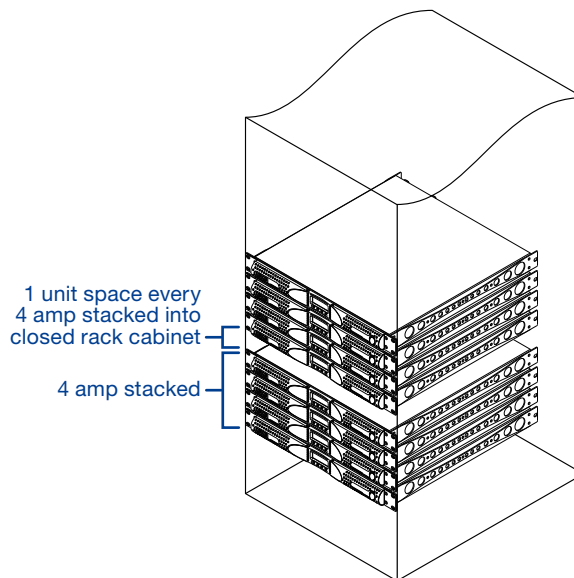

FIGURE 2: How to stack the amplifiers in closed racks.

4:2.Cleaning

Always use a dry cloth for cleaning the chassis and the front panel. Air filter cleaning should be scheduled according to the dust levels in the amplifier's operating environment.

⚡ Disconnect the AC main source before attempting to clean any part of the amplifier ⚠

In order to clean the vent filters you need to remove the front cover: never attempt to open any other part of the unit.

By means of a screwdriver Phillips PH1, unscrew the screws that lock the left and right cover grills on the front panel (ref. FIGURE 3), gently lift the covers and remove the filters. You may use compressed air to remove the dust from filters, or wash it with clean water: in the latter case ensure that the filters are dry before reassembly.

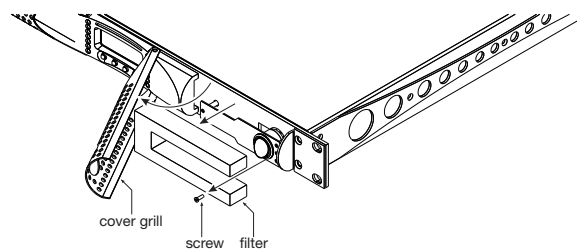

FIGURE 3: Cleaning air filters.

4:3.AC mains supply

The AC Main connection is made via the

- ▶ AMP CPC 45A connector in K6, K8, K10 and K20;
- ▶ IEC C20 connector in K3 and K2.

The **FIGURE 4** shows how to connect the mains power cable to the amplifier.



Make sure the AC mains voltage used is within the acceptable operating voltage range: 115V-230V ±10%.



It is important to connect the ground for safety, do not use adapters that disable the ground connection.



All K Series amplifiers have an automatic power factor correction system – PFC – for a perfect mains network interface. The PFC minimizes the reactive power reflected on the network and reduces the harmonic distortion on the voltage/current waveform: in this way the amplifier is seen as a resistive load from the mains network. Furthermore, the system allows performance to be maintained even in case of varying mains voltage.



Connection to the mains shall be done only by a electrotechnical Skilled person according the national requirements of the countries where the unit is sold



A

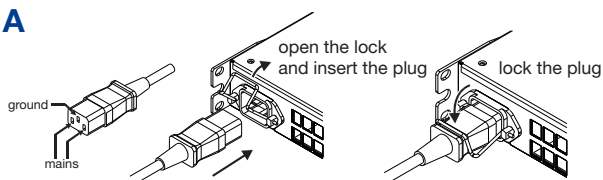

B

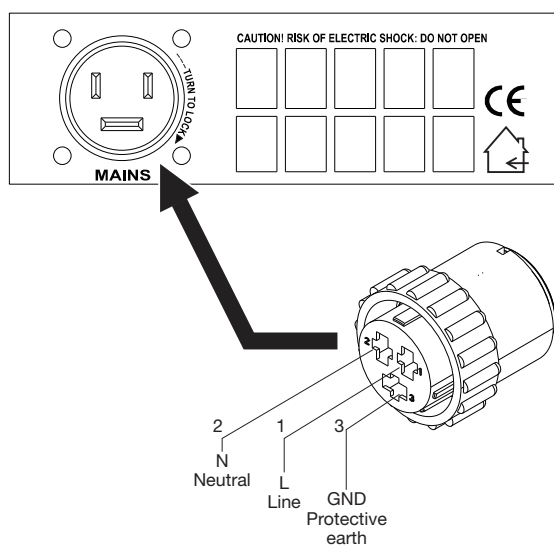

FIGURE 4: Mains connectors; A) IEC C20 in K2 and K3; B) AMP CPC 45A in K6, K8, K10 and K20.

4:4.Precautions regarding installation

Placing and using the amplifier for long periods of time on heat generating sources will affect its performance. Avoid placing the amplifier on heat generating sources. Install this amplifier as far as possible from tuners and TV sets. An amplifier installed in close proximity of such equipment may experience noise or generic performance degradation.

The power cord type provided with the amplifier are

- ▶ LAPP OLFLEX191 3G6 / SJT 3XAWG10 for K6, K8, K10 and K20.
- ▶ Bahoing SJT 3x16AWG or I-sheng SGIS 3G 1,5 mm² for K3 - K2.

WARNING: TO PREVENT FIRE OR ELECTRIC SHOCK

- ▶ This device must be powered exclusively by earth connected mains sockets in electrical networks compliant to the IEC 364 or similar rules.
- ▶ Install K6, K8, K10 and K20 into rack cabinet.
- ▶ With K6, K8, K10 and K20 a sectioning breaker between the mains connections and the amplifier must be installed inside the rack cabinet. Suggested device is 32A/250VAC, C or D curve, 10kA.
- ▶ With K2 and K3 provide a sectioning breaker between the mains connections and the amplifier. Suggested device is 16A/250VAC, C or D curve, 10kA.
- ▶ Before powering this amplifier, verify that the correct voltage rating is being used.
- ▶ Verify that your mains connection is capable of satisfying the power ratings of the device.
- ▶ Do not use this amplifier if the electrical power cord is frayed or broken.
- ▶ Output terminals are hazardous: wiring connection to these terminals require installation by an instructed person and the use of ready made leads.
- ▶ Take care to secure the output terminal before switching the device on.
- ▶ To avoid electrical shock, do not touch any exposed speaker wiring while the amplifier is operating.
- ▶ Do not spill water or other liquids into or on the amplifier.
- ▶ No naked flame sources such as lighted candles should be placed on the amplifier.
- ▶ Do not remove the cover. Failing to do so will expose you to potentially dangerous voltage.
- ▶ It is absolutely necessary to verify this fundamental requirement of safety and, in case of doubt, require an accurate check by qualified personnel.
- ▶ The manufacturer cannot be held responsible for damages caused to persons, things or data due to an improper or missing ground connection.
- ▶ Contact the authorized service center for ordinary and extraordinary maintenance.

Connections

5

Make sure the power switch is off before attempting to make any input or output connections.

By using good quality input and speaker cables, the likelihood of erratic signal behavior is reduced to a minimum. Whether you make them or buy them, look for good quality wires, connectors and soldering techniques.

5:1.Signal grounding

There is no ground switch or terminal on the K Series amplifiers. All shield terminals of input connections are directly connected to the chassis. This means that the unit's signal grounding system is automatic. In order to limit hum and/or interference entering the signal path, use balanced input connections.

In the interests of safety, the unit **MUST** always operate with electrical safety earth connected to the chassis via the dedicated wire in the 3-wire cable (ref. [Chapter 4:3.AC mains supply](#)). Never disconnect the ground pin on the AC mains power cord.

5:2.Analog input

Analog input is provided by means of two Neutrik XLR connectors in K2 and K3 or a couple of XLR/jack hybrid combo connectors in K6, K8, K10 and K20 amplifiers (refer to [Panel D, Panel F, p. vi](#)). Signal polarity for XLR and TRS plugs is shown in [Panel I, p. x](#).

5:3.Analog line output

Line out is provided in K2 and K3 via a couple of XLR connectors on the rear panel (refer [Panel D, p. iv](#)). In DSP equipped models, the output signal is pre-DSP, being a replica of the input signal.

5:4.Digital Input

On DSP equipped models, the XLR input for channel2 can switch to an AES3 digital input. The AES3/analog push-button located nearby the channel 2 XLR input connector toggles the XLR between analog and digital input (refer to [Panel D, Panel F, p. vi](#)).

In AES3 mode

- ▶ the channel 2 analog line out is off;
- ▶ the channel 1 analog input can be used as redundant input if the digital input fails.

The AES3 connection carries a channel pair through a 110 Ω nominal impedance wire in the form of a balanced (differential) digital signal: in AES3 XLR connectors the identification of hot and cold pins is not an issue; take care to never tie pin 2 or pin 3 (balanced signals) to pin 1 (ground).

Avoid the use of microphone cables in AES connections: impedance mismatch can result in signal reflections and jitter, causing bit errors at the receiver.

5:5.AESOP

The AESOP standard can transport a single bidirectional Fast Ethernet (IEEE 802.3u, 100 Mbit/s) control data stream and two independent separate AES3 digital audio monodirectional streams using one Cat5 cable.

All K Series amplifier with the optional KAESOP board installed are equipped with at least two RJ45 connectors, each of them being a single AESOP port, capable of sending and/or receiving data and audio.

If the amplifier has only two RJ45 plugs, these will be on the front panel. If four plugs are present, the rear two will be "primary" ports, while the two on the front panel are "secondary" ports.

Primary ports allow both data and AES3 streams; secondary ports, on the other hand, are data-only ports, allowing Ethernet connections only.

Cat5 standard twisted pair cables shall be used for connections up to 100 meters (328 ft). RJ45 pinout must comply to TIA/EIA-568-B and adopt the T568B scheme pinout, as show in [TABLE 1](#).









RJ45 connector seen from the front end		Color code (TIA/EIA-568-B)		Pin
	ORANGE / WHITE			1
	ORANGE			2
	GREEN / WHITE			3
	BLUE			4
	BLUE / WHITE			5
	GREEN			6
	BROWN / WHITE			7
	BROWN			8

TABLE 1: EtherCON/RJ45 T568B scheme pinout.

5:6.Loudspeaker connections



K6, K8, K10, K20
CLASS3 WIRING



K2, K3
CLASS2 WIRING

Output terminals are hazardous: wiring connection to these terminals require installation by an instructed person and the use of ready made leads.

Take care to secure the output terminal before switching the device on.

Two Neutrik NL4MD speakON connectors are located on the rear panel, each of them being a single output to loudspeaker (refer [Panel D, Panel F, p. vi](#)).

Pins 1+ and 2+ are physically bridged to the positive pole; pins 1- and 2- are physically bridged to the negative pole (refer [Panel J, p. x](#)).

In order to remain within safe operating conditions, when using low impedance loads – i.e. 4 Ω or less (8 Ω or less in bridge mode) –, connections must be made with a four wire cable. Use suitable wire gauges to minimize power and damping factor losses in speaker cables.

5:6.1.Bridge-tied load

Bridge-tied load connection can be achieved as described in [Panel J, p. x](#). In analog mode, only the input of channel 1 needs to be wired: link channel 2 to channel 1 by means of the link pushbutton located on the rear panel.

When operating with digital inputs – i.e. AES3 and AESOP – link the channels via software: do not switch the link pushbutton.

5:7.V Ext

The V Ext terminal is used to remotely manage the DSP in K Series DSP amplifier and enable remote on/off.

K Series provided with a KAESOP board have a dedicated 2 pin Phoenix connector MCV 1,5/ 2-G-3,81 - 1803426 located near the rear Ethernet ports. K Series with the RS-485 serial port implement the V Ext connection on pin 2 (pin 7) of the RJ45 rear connector.

When the V Ext port is powered by an external 12 V_{DC} (1 A max) power supply, the internal controller allows to control the DSP – if present – even without AC mains supply, and allows serial communication – via RS-485 or ethernet communication in KAESOP equipped models – for remote on/off via the Armonía Pro Audio Suite software.

K Series
Made in Italy PATENTED

ANALOG INPUTS/ LINK OUTPUTS
XLR : 1=GND 2=IN+ 3=IN-
DIGITAL INPUT (OPTIONAL)
XLR AES/EBU : 1=GND 2=IN+ 3=IN-
POWER OUTPUTS
(1+ PARALLEL 2+) = POSITIVE
(1- PARALLEL 2-) = NEGATIVE

"WARNING
To reduce the Risk of Fire
or Electric Shock, do not
Expose this Apparatus
to Rain or Moisture"

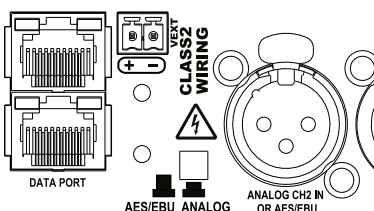

FIGURE 5: V Ext phoenix connector MCV 1,5/ 2-G-3,81.

5:8.RS-485 connection

K Series amplifiers without an optional KAESOP board can be remotely controlled via an RS-485 connection.

Remote connection data cables must have an 8P8C modular plug – namely RJ45 plug – to be inserted in the rear port labelled “DATA PORT”.

By plugging an RJ45 plug and selecting the unit’s remote ID via the rotary trimmers, the amp is ready to be remotely controlled. Please note that ID numer 00 is not allowed.

The recommended arrangement of the connections is a series of point-to-point (multidropped) nodes – i.e. a line or bus. Ideally, the two ends of the line should be terminated with a resistor, typically 120 Ω for twisted pairs. Powersoft recommend the use of Ethernet Cat5 straight through – patch – cables with pin/pair assignments TIA/EIA-568-B, i.e. T568B (ref. [TABLE 1](#)).

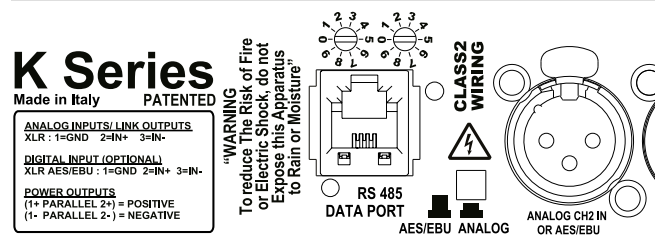

FIGURE 6: Data port and ID selectors for serial connection; note that ID numer 00 is not allowed.

LEDs and display menu

In all K Series amplifiers, the combination of the front panel buttons together with the LCD display allow the user access to detailed information and complete control over the amplifier's status. Each button has multiple functions and the display shows the current active function for each button. This chapter illustrates all the functions and settings accessible via the amplifier front panel.

All the setup and settings functions described in this section can be also accessed through a computer with Powersoft's Armonía Pro Audio Suite software. Armonía is a software environment that offers an easy to use end user remote control interface and signal processing capabilities.







Armonía Pro Audio Suite is available for free on the Armonía forum:

<http://www.powersoft-audio.com/en/armonia-forum>

Please note that when an Armonía client is connected to the amplifier, any local operation is overridden by the software.

6:1.LED chart

The LED columns on the front of the amp can work as output voltage or current meters. When the LED bars are set to meter output voltage, for example, the meters on the LCD screen will indicate output current values. The vice versa is true: LED bars set as output current meters, LCD display bars become output voltage meters.

Color	Solid	Blinking	
	RED	Signal clipping OR channel muted for protection ¹	Tone detection problem
	YELLOW	Temperature above 85°C OR output level ² -2 dB	Critical temperature (80° - 85°C)
	GREEN	output level ² -3 dB	
	GREEN	output level ² -6 dB	
	GREEN	output level ² -9 dB	
	GREEN	output level ² -15 dB	
	GREEN	input signal is above -60 dBV OR output level ² -18 dB	

¹ In case of a short circuit protection event, the LCD screen will read "PROT".

² With respect to the output clipping threshold.

TABLE 2: LED chart.

6:2.Front display

When the amp is turned on, the main screen appears after a short presentation.

The first line of the screen will read "WAIT" while the system undergoes an initial batch of internal tests to determine the status of the amp. If all parameters are normal, "READY" will replace "WAIT" on the display.

System parameters are continuously monitored by the internal controller. If any parameter value should fall out of its correctly operating range, a code error relative to that particular parameter will appear on the third line of the LCD meter at the corresponding channel number. Should the parameter be out of range for both adjacent channels, the error code will appear in between the two compromised channels.

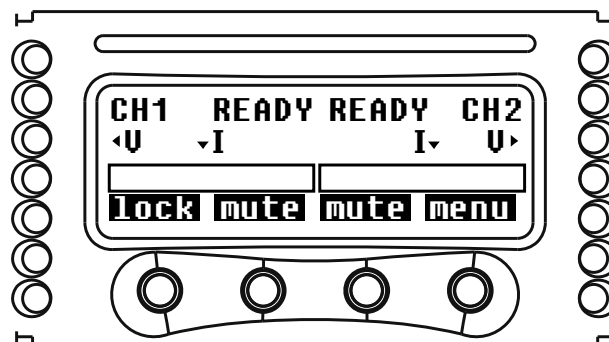

FIGURE 7: K Series front display.

The fourth line of the front panel LCD screen shows the functions of the buttons immediately below. A beep confirms that a button has been pressed; please note that this sound is not mutable.

Pressing the button directly below the "menu" label on the LCD screen gives access to the amplifier's main menu. If an Armonía client is connected to the amplifier, a yellow shadow will appear in the software workspace view, signaling local access to the amplifier.

6:2.1.How to navigate the main menu

The K Series main menu can be accessed by pressing the first button on the right, underneath the LCD label "menu".

The up and down arrows allow to scroll the menu items. To access further menu voices branching off a specific menu item, select it and press the "menu" button once.

Some submenus in the K Series amps require the user to set a numerical value for specific parameters using the front panel buttons. In order to speed this process up, these submenus dedicate two of the four available buttons to switching to a fast or slow parameter increment mode.

When in the “slow” mode, the up and down arrows increase or decrease the parameter by a the smallest amount possible. The “fast” mode will increase or decrease the parameter value by an amount equal to 10 times the amount increased in the “slow” mode.

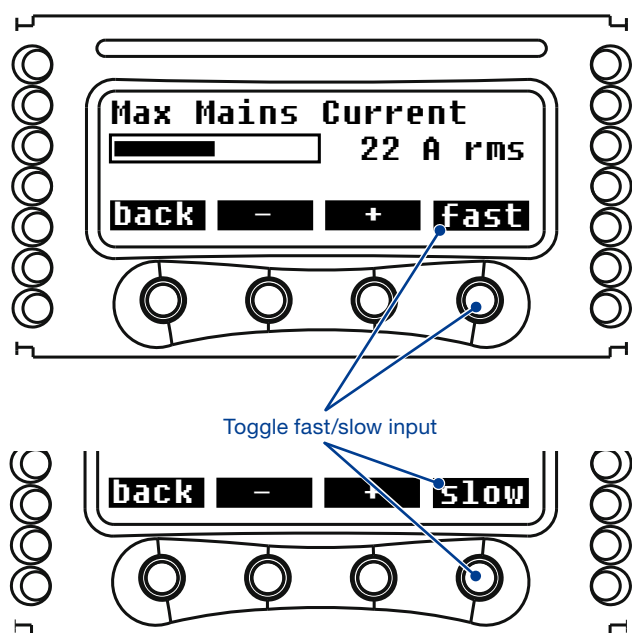

FIGURE 8: Fast/slow data emission.

For example: in “slow” mode a single “+” button press will increase the Max mains current from 22 A to 23 A; in “fast” mode a single “+” button press will increase the Max mains current from 22 A to 32 A.

6:2.2.Menu diagrams

On [Panel H, p. viii](#) you will find the diagram providing an overview of the structure of the Main menu and DSP settings menu accessible via the front panel on K Series amplifiers.

Warranty and assistance

7:1.Warranty

7:1.1.Product warranty

Powersoft guarantees its manufactured products to be free from defective components and factory workmanship for a period of 48 (forty eight) months, starting from the date of purchase printed on Powersoft's (or any of its Authorized Dealer's) invoice to the end customer. All warranty repairs and retrofits must be performed at Powersoft facilities or at an Authorized Service Center at no cost for the purchaser. Warranty exclusion: Powersoft's warranty does not cover product malfunctioning or failure caused by: misuse, abuse, repair work or alterations performed by non-authorized personnel, incorrect connections, exposure to harsh weather conditions, mechanical damages (including shipping accidents), and normal wear and tear. Powersoft will perform warranty services provided that the product is not damaged during transportation.

7:1.2.Return of Goods

Goods can be returned to Powersoft only after they have been granted a Return Merchandise Authorization (RMA) number to be attached to the external packaging. Powersoft (or its Authorized Service Center) has the right to refuse any returned good without a RMA number.

7:1.3.Repair or replacement

Powersoft reserves the right to repair or replace any defective goods covered by product warranty at its sole discretion and as it deems best.

7:1.4.Cost and responsibility of transport

The purchaser (or end user/customer) is solely responsible for all transportation costs and risks associated with sending warranty covered goods to Powersoft or its Authorized Service Center. Powersoft will assume full responsibility and cover all costs incurred to send the goods back to the purchaser (or end user/customer).

7:2.Assistance

There are no user-serviceable parts in your amplifier. Refer servicing to qualified technical personnel. In addition to having an in-house service department, Powersoft supports a network of authorized service centers. If your amplifier needs repair contact your Powersoft dealer (or distributor). You can also contact the Powersoft Technical Service department to obtain the location of the nearest authorized service center.

Even though most product malfunctioning can be solved at your premises through Powersoft Customer Care or your direct knowledge, occasionally, due the nature of the failure, it might be necessary to return defective products to Powersoft for repair. In the latter case, before shipping, you are kindly asked to follow step by step the procedure described below: Obtain the "Defect Report Form" by contacting our Customer Care Department via email: service@powersoft.it or download the "Defect Report Form" from Powersoft's website (<http://www.powersoft-audio.com/en/support/service>).

Fill out one "Defect Report form" for each returned item (the form is an editable tab guided document) and save as your name, amp model and serial Number (for example: `distributorenamek10sn17345.doc`) providing all required information except the RMA code/s and send it to service@powersoft.it for Powersoft approval.

In case of defect reports approved by the Powersoft Customer Service Representative you will receive an RMA authorization code (one RMA code for each returning device). Upon receiving the RMA code you must package the unit and attach the RMA code outside the pack, protected in a waterproof transparent envelope so it is clearly visible.

All returning items must be shipped to the following address:

Powersoft
Via Enrico Conti, 13-15
50018 Scandicci (FI) Italy

In case of shipment from countries NOT belonging to the European Community make sure you have also followed the instructions described in the document available for download at the TEMPORARY EXPORTATION / IMPORTATION PROCEDURE link at <http://www.powersoft-audio.com/en/support/service>.

Thank you for your understanding and cooperation and continued support as we work to improve our partnership.

Importantes instructions de sécurité

EXPLICATION DES SYMBOLES GRAPHIQUES

 La triangle avec le symbol du foudre est employée pour alerter l'utilisateur au risque de décharge électrique.

 Le triangle avec un point d'exclamation est employée pour alerter l'utilisateur d'instruction importantes pour lors opérations de maintenance.

 Le marquage CE indique la conformité à la directive de basse tension et la compatibilité électromagnétique.

 Symbole pour la connexion à la terre.

 Symbole indiquant que l'équipement est destiné à l'emploi à l'intérieur.

 Symbole pour la conformité al la Directive 2002/96/EC et la Directive 2003/108/EC du Parlement Européen sur les équipements électriques et électroniques (WEEE).

 **MISE EN GARDE : AFIN DE RÉDUIRE LES RISQUES DE CHOC ÉLECTRIQUE, N'ESSAYEZ PAS D'OUVRIRE L'UNITÉ, MEME EN PARTIE. AUCUNE PIÈCE A L'INTERIEUR NE PEUT ETRE CHANGÉE PAR L'UTILISATEUR. LAISSEZ L'ENTRETIEN A UN PERSONNEL QUALIFIÉ.**

 **POUR INTERROMPRE COMPLÈTEMENT L'ALIMENTATION ÉLECTRIQUE DE L'UNITÉ, DÉBRANCHEZ LE CORDON D'ALIMENTATION DE LA PRISE DE COURANT.***

 **LES FICHES DU CORDON D'ALIMENTATION DOIVENT RESTER ACCESSIBLES A TOUT MOMENT.****

 **AFIN DE RÉDUIRE LES RISQUES D'INCENDIE ET D'ÉLECTROCUTION, N'EXPOSEZ PAS CET APPAREIL À LA PLUIE OU À L'HUMIDITÉ. L'UNITÉ NE DOIT JAMAIS ÊTRE EXPOSÉ AUX ÉCLABOUSSURES, AU DÉVERSEMENT OU À L'ÉGOUTTEMENT DE LIQUIDES, QUELS QU'ILS SOIENT.**

 **K6, K8, K10 ET K20 DOIT ÊTRE INSTALLÉ DANS UN RACK ARMOIRE : AU LIEU DE CONNECTER L'AMPLIFICATEUR POUR LE RÉSEAU ÉLECTRIQUE DIRECTEMENT, BRANCHEZ LA FICHE DE L'AMPLIFICATEUR VIA LE DISJONCTEUR AUX PANNEAU DE DISTRIBUTION ÉLECTRIQUE À L'INTÉRIEUR DE L'ARMOIRE.**

 **QUAND L'UNITÉ EST INSTELLÉ DANS UNE ARMOIRE OU UNE ÉTAGÈRE, ASSUREZ-VOUS QU'IL Y À UN ESPACE SUFFISANT TOUT AUTOUR POUR PERMETTRE UNE BONNE VENTILATION (50 CM DES ORIFICES DE VENTILATION AVANT ET ARRIÈRE).**

* K6, K8, K10 and K20: interrompre le réseau par commutation de le disjoncteur.

** Valable seulement pour le K2 et K3 modèles; on fournis avec K6, K8, K10 et K20 un cordon avec fils libres (c'est à dire sans fiche) : cette solution est destinée à connecter l'appareil à un disjoncteur sur le réseau. Se référer aux instructions d'installation pour sélectionner le disjoncteur de sectionnement approprié.



L'énergie électrique peut remplir beaucoup de fonctions utiles. Cet appareil a été conçu et fabriqué pour assurer votre propre sécurité. Mais UNE UTILISATION INCORRECTE PEUT ENTRAÎNER UN RISQUE POTENTIEL D'ÉLECTROCUTION OU D'INCENDIE. Afin de ne pas annuler les dispositifs de sécurité incorporés dans cet appareil, observez les règles fondamentales suivantes pour son installation, son utilisation et sa réparation. Veuillez lire attentivement ces "Importantes mesures de sécurité" avant d'utiliser l'appareil.

Importantes instructions de sécurité

1. Lisez les directives suivantes.
2. Conservez ces directives.
3. Observez et respectez tous les avertissements.
4. Suivez toutes les directives.
5. N'utilisez pas cet appareil près de l'eau.
6. Nettoyez cet appareil uniquement avec un chiffon sec.
7. Ne bouchez pas les fentes de ventilation. Respectez les directives du fabricant pour l'installation de l'appareil.
8. N'installez pas l'appareil à proximité d'une source de chaleur telle qu'un radiateur, une bouche d'air chaud, une cuisinière ou tout autre appareil (y compris des amplificateurs) émettant de la chaleur.
9. Ne désactivez pas le dispositif de sécurité appliqué à la fiche polarisée ou à la fiche avec mise à la terre. Une fiche polarisée est équipée de deux lames dont l'une est plus large que l'autre. Une fiche avec mise à la terre est équipée de deux lames et une broche destinée à la mise à la terre. La lame la plus large et la troisième broche sont des dispositifs de sécurité. Si vous ne réussissez pas à brancher la fiche fournie dans la prise de courant, consultez un électricien et faites remplacer la prise par une neuve.
10. Ne placez pas le cordon d'alimentation dans des endroits passants et assurez-vous qu'il ne peut pas être pincé, surtout au niveau des fiches, de la prise de courant et à l'endroit où il sort de l'appareil.
11. Utilisez uniquement les éléments de raccordement et les accessoires recommandés par le fabricant.
12. Utilisez l'appareil uniquement avec le chariot, le trépied, le support ou la table recommandés par le fabricant ou achetés avec l'appareil. Lorsque vous utilisez un chariot, prenez des précautions en déplaçant le chariot et l'appareil afin de ne pas les renverser, ce qui pourrait entraîner des blessures. 
13. Débranchez cet appareil en cas d'orage ou lorsque vous ne l'utilisez pas pendant de longues périodes.
14. Pour toute réparation, adressez-vous à un réparateur qualifié. Faites réparer l'appareil s'il a été endommagé de quelque manière que ce soit, par exemple si le cordon d'alimentation ou sa fiche sont endommagés, si du liquide ou tout autre corps étranger a pénétré dans l'appareil, si l'appareil a été exposé à la pluie ou à l'humidité, s'il ne fonctionne pas normalement ou s'il est tombé.

Numéros 9 et 13 ne s'appliquent qu'aux K2 et K3.

Instrucciones de seguridad importantes

EXPLICACIÓN DE LOS SÍMBOLOS GRÁFICOS

 El triángulo con el símbolo de rayo eléctrico es usado para alertar al usuario de el riesgo de un choque eléctrico.

 El triángulo con el signo de admiración es usado para alertar al usuario de instrucciones importantes de operación o mantenimiento.

 La marca CE indica el cumplimiento de la directiva de bajo voltaje y de compatibilidad electromagnética.

 Símbolo de la conexión a tierra.

 Símbolo que indica que el equipo es sólo para uso en interiores.

 Símbolo de conformidad con la Directiva 2002/96/EC y Directiva 2003/108/EC del Parlamento Europeo sobre los aparatos eléctricos y electrónicos (WEEE).

 **PRECAUCIÓN: PARA REDUCIR EL RIESGO DE DESCARGA ELÉCTRICA, NO DESMONTE LA TAPA (NI EL PANEL TRASERO). NO HAY PIEZAS REPARABLES POR EL USUARIO EN EL INTERIOR. LLÉVELO A REPARAR A PERSONAL DE SERVICIO CUALIFICADO.**

 **PARA DESCONECTAR COMPLETAMENTE EL APARATO, EL ENCHUFE DEL CABLE DE ALIMENTACIÓN DE LA UNIDAD DEBERÁ SER RETIRADO DE LA TOMA DE CORRIENTE.***

 **EL ENCHUFE DEL CABLE DE ALIMENTACIÓN DEBERÁ PERMANECER FÁCILMENTE ACCESIBLE.****

 **NO EXPONGA ESTE UNIDAD A LA LLUVIA O LA HUMEDAD, GOTEO O SALPICADURAS. NO COLOQUE OBJETOS LLENOS DE LÍQUIDOS, TALES COMO VASIJAS, SOBRE EL APARATO.**

 **K6, K8, K10 Y K20 SE DEBEN INSTALAR EN ARMARIOS RACK: EN LUGAR DE CONECTAR EL AMPLIFICADOR A LA RED ELÉCTRICA DIRECTAMENTE, CONECTE LAS CONEXIONES DE RED DEL AMPLIFICADOR A TRAVÉS DE UN INTERRUPTOR DE SECCIONAMIENTO A UN PANEL DE DISTRIBUCIÓN DE ENERGÍA EN EL INTERIOR DEL ARMARIO RACK.**

 **CUANDO LA UNIDAD SE INSTALA EN UN ARMARIO O UN ESTANTE, ASEGÚRESE QUE TENGA SUFICIENTE ESPACIO EN TODOS LOS LADOS PARA PERMITIR LA VENTILACIÓN ADECUADA (50 CM DE LOS ORIFICIOS DE VENTILACIÓN DELANTEROS Y TRASEROS).**

* K6, K8, K10 and K20: interrumpir la red apagando el disyuntor de la red.

** Válido para los modelos K3 y K3 sólo; con K6, K8, K10 and K20 se proporciona un cable de alimentación de hilos libres (es decir, sin enchufe): se provee esta solución para conectar el dispositivo a un disyuntor en la red. Consulte las instrucciones de instalación para seleccionar el disyuntor impecables.

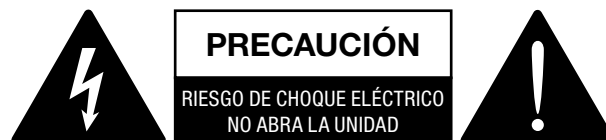

La energía eléctrica puede realizar numerosas funciones útiles. Esta unidad ha sido diseñada y fabricada para brindarle un funcionamiento seguro. Sin embargo, el USO INCORRECTO O PUEDE PRODUCIR INCENDIOS O DESCARGAS ELÉCTRICAS. Para no anular las salvaguardas incorporadas a este producto, asegúrese de respetar las reglas básicas siguientes para su instalación, uso y servicio. Por favor lea atentamente estas "Salvaguardas importantes" ante del uso.

Instrucciones de seguridad importantes

1. Lea estas instrucciones.
2. Guarde estas instrucciones.
3. Respete todas las advertencias.
4. Siga todas las instrucciones.
5. No utilice este aparato cerca del agua.
6. Límpielo únicamente con un paño seco.
7. No bloquee los orificios de ventilación. Instale el aparato según las instrucciones del fabricante.
8. No lo instale cerca de fuentes de calor como radiadores, calefactores, hornos u otros aparatos (incluidos los amplificadores) que generen calor.
9. Respete la finalidad de seguridad del enchufe polarizado o de tipo conexión a tierra. Un enchufe polarizado presenta dos contactos, uno más ancho que el otro. Un enchufe de tipo conexión a tierra dispone de dos contactos y una tercera clavija de conexión a tierra. El contacto ancho o la tercera clavija se suministra para su seguridad. Si el enchufe suministrado no encaja en la toma de corriente, póngase en contacto con un electricista para el reemplazo del tomacorriente que quedó obsoleto.
10. Para proteger el cable de alimentación, aléjelo de lugares de paso o donde pueda ser aplastado, especialmente en la punta de los enchufes, los tomacorrientes o el punto donde el cable sale del aparato.
11. Utilice únicamente los complementos o accesorios especificados por el fabricante.
12. Utilícelo únicamente con el carro, pedestal, trípode, abrazadera o mesa especificados por el fabricante o vendidos con el aparato. Si utiliza un carro, tenga cuidado al moverlo junto con el aparato para evitar lesiones en el caso de una caída. 
13. Desenchufe el aparato durante tormentas eléctricas o cuando no se utilice durante períodos de tiempo prolongados.
14. Solicite servicio técnico únicamente a personal de servicio técnico especializado. Será necesario solicitar servicio técnico si el aparato ha sufrido daños como, por ejemplo, si el cable de alimentación o el enchufe están dañados, se ha vertido líquido o se ha caído algún objeto dentro del aparato, o bien si dicho aparato ha sido expuesto a la lluvia o a humedad, no funciona correctamente o se ha caído.

Números 9 y 13 se aplican sólo a K2 y K3.

Importanti istruzioni di sicurezza

SPIEGAZIONE DEI SIMBOLI GRAFICI

 Il triangolo con il lampo è utilizzato per avvisare l'utente del rischio di scossa elettrica.

 Il triangolo con il punto esclamativo è utilizzato per avvisare l'utente di importanti istruzioni d'uso e manutenzione.

 The CE-mark indicates the compliance with the low voltage and electromagnetic compatibility.

 Simbolo della connessione di terra.

 Simbolo che indica che l'apparecchio è solo per uso interno.

 Simbolo di conformità alla Direttiva 2002/96/CE e alla Direttiva 2003/108/CE del Parlamento Europeo sulle apparecchiature elettriche ed elettroniche (RAEE).

 **ATTENZIONE: PER RIDURRE IL RISCHIO DI SCOSSE ELETTRICHE, NON TENTARE DI APRIRE ALCUNA PARTE DELL'UNITÀ. NON CI SONO PARTI INTERNE AD USO UTENTE. RIVOLGERSI A PERSONALE QUALIFICATO PER L'ASSISTENZA.**

 **PER SCOLLEGARE COMPLETAMENTE QUESTO APPARECCHIO DALL'ALIMENTAZIONE PRINCIPALE, SCOLLEGARE LA SPINA DEL CAVO DI ALIMENTAZIONE DALLA PRESA.***

 **LA SPINA DEL CAVO DI ALIMENTAZIONE DI RETE DEVE ESSERE SEMPRE ACCESSIBILE.****

 **NON ESPORRE QUESTO APPARECCHIO ALLA PIOGGIA, UMIDITÀ O SOSTANZE LIQUIDE. OGGETTI PIENI DI LIQUIDI, COME VASI, NON DEVONO ESSERE COLLOCATI SU QUESTO APPARATO.**

 **K6, K8, K10 E K20 DEVONO ESSERE INSTALLATI IN ARMADI RACK: INVECE DI COLLEGARE DIRETTAMENTE L'AMPLIFICATORE ALLA RETE ELETTRICA, COLLEGARE IL CAVO DI ALIMENTAZIONE DELL'AMPLIFICATORE AD UN INTERRUTTORE DI SEZIONAMENTO IN UN PANNELLO DI DISTRIBUZIONE ALL'INTERNO DELL'ARMADIO RACK.**

 **QUANDO L'UNITÀ È INSTALLATA IN UN MOBILE O SU UNO SCAFFALE, ASSICURARSI CHE RIMANGA SPAZIO SUFFICIENTE SU TUTTI I LATI PER CONSENTIRE UN'ADEGUATA VENTILAZIONE (50 CM DAI FORI DI VENTILAZIONE ANTERIORI E POSTERIORI).**

* K6, K8, K10 e K20: interrompere l'alimentazione elettrica commutando l'interruttore di sezionamento.

** Valido solo per i modelli K2 e K3; con K6, K8, K10 e K20 è fornito un cavo di alimentazione con i terminali liberi (cioè senza spina): questa soluzione è pensata per il collegamento diretto all'interruttore di sezionamento di rete. Fare riferimento al manuale per le istruzioni di installazione e il corretto dimensionamento dell'interruttore.



L'elettricità viene usata per svolgere molte funzioni utili, ma può anche causare danni personali o agli oggetti se applicata in modo improprio. Questo prodotto è stato progettato e realizzato con la massima attenzione alla sicurezza. Tuttavia, UN USO IMPROPRIO PUÒ PRODURRE SCOSSE ELETTRICHE E/O INCENDI. Per evitare potenziali pericoli, osservare le seguenti istruzioni durante l'installazione, l'utilizzo e la pulizia del prodotto. Per garantire la sicurezza e prolungare la vita utile del monitor LCD, leggere attentamente le seguenti precauzioni prima di usare il prodotto.

Importanti istruzioni di sicurezza

1. Leggere queste istruzioni.
2. Conservare le istruzioni.
3. Tenere conto di tutti gli avvisi.
4. Seguire tutte le istruzioni.
5. Non usare l'apparecchio in prossimità di acqua.
6. Pulire solo con un panno asciutto.
7. Non ostruire le prese di ventilazione. Installare secondo le indicazioni del produttore.
8. Non installare vicino a fonti di calore quali radiatori, bocchette dell'aria calda, stufe o altri apparecchi (compresi gli amplificatori) che producono calore.
9. Non compromettere la sicurezza delle spine polarizzate o con messa a terra. Una spina polarizzata ha due terminali, di cui uno più grande dell'altro. Una spina con messa a terra ha tre terminali, di cui uno per la messa a terra. Il terminale più grande o il terzo terminale ha una funzione di sicurezza. Se la spina in dotazione non è adatta alla presa, far sostituire tale presa obsoleta da un elettricista.
10. Evitare di calpestare o di schiacciare il cavo di alimentazione, in particolare in corrispondenza di spine, prese della corrente e punto di uscita dall'apparecchio.
11. Usare solo accessori specificati dal produttore.
12. Usare solo con il supporto indicato dal produttore (carrello, piedistallo, cavalletto, staffa o tavolo) o venduto con l'apparecchio. Se si usa il carrello, fare attenzione durante il trasporto dell'apparecchio sul carrello per evitare danni causati dal ribaltamento.
13. Scollegare l'apparecchio dalla presa di corrente durante i temporali o se inutilizzato per lunghi periodi di tempo.
14. Ricorrere a personale qualificato per qualsiasi intervento. Tali interventi sono necessari in caso di guasti dell'apparecchio quali danneggiamento del cavo di alimentazione o della spina, versamento di liquidi o caduta di oggetti nell'apparecchio, esposizione a pioggia o umidità o se l'apparecchio non funziona normalmente o è caduto.



I numeri 9 e 13 si applicano solo a K2 e K3.

K20, K20 DSP+AESOP

Channel Handling	
Number of output channels	2 mono, bridgeable per ch. pair
Number of input channels:	
Analog	2x Combo XLR/TRS
AES3	1x XLR ^{1,2}
	AESOP via 2x RJ45 ²
Number of output channels:	
Speaker	2x NL4MD speakON

Audio				
Gain	26 dB	29 dB	32 dB	35 dB
Input sensitivity @ 8 Ω	7.37 V	5.22 V	3.68 V	2.62 V
Max input level	27 dB	24 dB	21 dB	18 dB
Gate	-52 dBu	-55 dBu	-58 dBu	-61 dBu
Frequency Response (±0.5 dB , 1 W @ 8 Ω)	20 Hz - 20 kHz			
Crosstalk (1 kHz)	> 66 dB			
S/N ratio (20 Hz - 20 kHz A-Weighted @ 8 Ω)	> 110 dB			
Input impedance	10 kΩ balanced			
THD+N (from 0.1 W to Full Power)	< 0.5% (typical < 0.05%)			
DIM (from 0.1 W to Full Power)	< 0.5% (typical < 0.05%)			
Slew Rate (input filter bypassed @ 8 Ω)	> 50 V/μs			
Damping Factor @ 8 Ω, 20 Hz - 200 Hz	> 5000			

DSP ³	
AD converters	24 Bit Tandem™ @ 96 kHz 127 dB-A Dynamic Range - 0.005 % THD+N
DA converters	24 Bit Tandem™ @ 192 kHz 122 dB-A Dynamic Range - 0.003 % THD+N
Sample rate converter	24 Bit @ 44.1 kHz to 192 kHz 140 dB Dynamic Range - 0.0001 % THD+N
Internal precision	40 bit floating point
Latency	6.0 ms fixed latency architecture
Memory/Presets	8 MB (RAM) plus 2 MB flash for presets: 50 stored locally + 150 stored on SmartCard
Delay	4 s (input) + 32 ms (output) for time alignment
Equalizer	Raised-cosine, custom FIR, parametric IIR: peaking, hi/lo-shelving, all-pass, band-pass, band-stop, hi/lo-pass
Crossover	linear phase (FIR), hybrid (FIR-IIR), Butterworth, Linkwitz-Riley, Bessel: 6 dB/oct to 48 dB/oct (IIR)
Limiters	TruePower™, RMS voltage, RMS current, Peak limiter
Damping control	Active DampingControl™ and LiveImpedance™ measurement

Networking	
Standards compliance	RS-485 serial connection or auto-sensing 10/100 Mbps UTP ports + AESOP ²
Supported topologies	star, daisy-chain, closed loop ²
Remote interface	Armonia Pro Audio Suite™
Ports	
Non AESOP models	Rear: 1 x RJ45 (RS-485 + V Ext)
2 port AESOP ² models	Front: 2 x RJ45 (Ethernet + AESOP connection)
4 port AESOP ² models	Front: 2 x RJ45 (Ethernet) Rear: 2 x RJ45 (Ethernet + AESOP connection)
Auxiliary supply ³	12 V / 1 A max for DSP management and remote on/off via RJ45 or 2 pin Phoenix ² MCV 1,5/ 2-G-3,81

Output Stage	
Maximum output power per channel @ 8 Ω	2700 W
Maximum output power per channel @ 4 Ω	5200 W
Maximum output power per channel @ 2 Ω	9000 W
Maximum output power @ 8 Ω Bridged	10400 W
Maximum output power @ 4 Ω Bridged	18000 W
Peak total output, all channels driven	18000 W
Maximum unclipped output voltage	225 V _{peak}
Maximum output current	125 A _{peak}

The power figure is calculated by driving and loading symmetrically all the channels: uneven loads allow to achieve highest performance.

AC Mains Power				
Power supply	Universal regulated switch more with PFC			
Nominal voltage (±10%)	100-240 V @ 50-60Hz			
Power factor (> 500 W output)	> 0.95			
Consumption/current draw	@ 115 V	@ 230 V		
Idle	91 W	1.3 A	88 W	1.17 A
1/8 Max Output Power @ 4 Ω	1650 W	15.8 A	1625 W	7.9 A
1/4 Max Output Power @ 4 Ω	3250 W	29.3 A	3250 W	14.7 A
AC Mains connector	AMP CPC 45A connector - 45 A max (region-specific power cord provided)			

Thermal		
Operating temperature	0° - 45° C / 32° - 113° F	
Cooling	Fan, continuously variable speed, temperature controlled, front to rear airflow	
Thermal dissipation		
Idle	682 BTU/h	171.9 kcal/h
1/8 Max Output Power @ 4 Ω	1590 BTU/h	400.7 kcal/h
1/4 Max Output Power @ 4 Ω	2498 BTU/h	629.5 kcal/h

Construction	
Dimensions	483 mm x 44.5 mm x 475 mm (19.0 in x 1.8 in x 18.7 in)
Weight	12 kg (26.5 lb)

¹ Common to channel 2 XLR analog input, either analog or AES3 depending on system configuration.

² Available only in KAESOP equipped models.

³ Only for KDSP equipped model

K10, K10 DSP+AESOP

Channel Handling	
Number of output channels	2 mono, bridgeable per ch. pair
Number of input channels:	
Analog	2x Combo XLR/TRS
AES3	1x XLR ^{1,2}
	AESOP via 2x RJ45 ²
Number of output channels:	
Speaker	2x NL4MD speakON

Audio				
Gain	26 dB	29 dB	32 dB	35 dB
Input sensitivity @ 8 Ω	6.34 V	4.49 V	3.18 V	2.25 V
Max input level	27 dBu	24 dBu	21 dBu	18 dBu
Gate	-52 dBu	-55 dBu	-58 dBu	-61 dBu
Frequency Response (±0.5 dB , 1 W @ 8 Ω)	20 Hz - 20 kHz			
Crosstalk (1 kHz)	> 66 dB			
S/N ratio (20 Hz - 20 kHz A-Weighted @ 8 Ω)	> 110 dB			
Input impedance	10 kΩ balanced			
THD+N (from 0.1 W to Full Power)	< 0.5% (typical < 0.05%)			
DIM (from 0.1 W to Full Power)	< 0.5% (typical < 0.05%)			
Slew Rate (input filter bypassed @ 8 Ω)	> 50 V/μs			
Damping Factor @ 8 Ω, 20 Hz - 200 Hz	> 5000			

DSP ³	
AD converters	24 Bit Tandem™ @ 96 kHz 127 dB-A Dynamic Range - 0.005 % THD+N
DA converters	24 Bit Tandem™ @ 192 kHz 122 dB-A Dynamic Range - 0.003 % THD+N
Sample rate converter	24 Bit @ 44.1 kHz to 192 kHz 140 dB Dynamic Range - 0.0001 % THD+N
Internal precision	40 bit floating point
Latency	6.0 ms fixed latency architecture
Memory/Presets	8 MB (RAM) plus 2 MB flash for presets: 50 stored locally + 150 stored on SmartCard
Delay	4 s (input) + 32 ms (output) for time alignment
Equalizer	Raised-cosine, custom FIR, parametric IIR: peaking, hi/lo-shelving, all-pass, band-pass, band-stop, hi/lo-pass
Crossover	linear phase (FIR), hybrid (FIR-IIR), Butterworth, Linkwitz-Riley, Bessel: 6 dB/oct to 48 dB/oct (IIR)
Limiters	TruePower™, RMS voltage, RMS current, Peak limiter
Damping control	Active DampingControl™ and LiveImpedance™ measurement

Networking	
Standards compliance	RS-485 serial connection or auto-sensing 10/100 Mbps UTP ports + AESOP ²
Supported topologies	star, daisy-chain, closed loop ²
Remote interface	Armonia Pro Audio Suite™
Ports	
Non AESOP models	Rear: 1 x RJ45 (RS-485 + V Ext)
2 port AESOP ² models	Front: 2 x RJ45 (Ethernet + AESOP connection)
4 port AESOP ² models	Front: 2 x RJ45 (Ethernet) Rear: 2 x RJ45 (Ethernet + AESOP connection)
Auxiliary supply ³	12 V / 1 A max for DSP management and remote on/off via RJ45 or 2 pin Phoenix ² MCV 1,5/ 2-G-3,81

Output Stage	
Maximum output power per channel @ 8 Ω	2000 W
Maximum output power per channel @ 4 Ω	4000 W
Maximum output power per channel @ 2 Ω	6000 W
Maximum output power @ 8 Ω Bridged	8000 W
Maximum output power @ 4 Ω Bridged	12000 W
Peak total output, all channels driven	12000 W
Maximum unclipped output voltage	200 V _{peak}
Maximum output current	125 A _{peak}

The power figure is calculated by driving and loading symmetrically all the channels: uneven loads allow to achieve highest performance.

AC Mains Power				
Power supply	Universal regulated switch more with PFC			
Nominal voltage (±10%)	100-240 V @ 50-60Hz			
Power factor (> 500 W output)	> 0.95			
Consumption/current draw	@ 115 V	@ 230 V		
Idle	91 W	1.3 A	84 W	1.17 A
1/8 Max Output Power @ 4 Ω	1250 W	12.2 A	1250 W	6.1 A
1/4 Max Output Power @ 4 Ω	2500 W	22.6 A	2500 W	11.3 A
AC Mains connector	AMP CPC 45A connector - 45 A max (region-specific power cord provided)			

Thermal	
Operating temperature	0° - 45° C / 32° - 113° F
Cooling	Fan, continuously variable speed, temperature controlled, front to rear airflow
Thermal dissipation	
Idle	546 BTU/h 137.6 kcal/h
1/8 Max Output Power @ 4 Ω	1244 BTU/h 313.5 kcal/h
1/4 Max Output Power @ 4 Ω	1943 BTU/h 489.6 kcal/h

Construction	
Dimensions	483 mm x 44.5 mm x 475 mm (19.0 in x 1.8 in x 18.7 in)
Weight	12 kg (26.5 lb)

¹ Common to channel 2 XLR analog input, either analog or AES3 depending on system configuration.

² Available only in KAESOP equipped models.

³ Only for KDSP equipped model

K8, K8 DSP+AESOP

Channel Handling	
Number of output channels	2 mono, bridgeable per ch. pair
Number of input channels:	
Analog	2x Combo XLR/TRS
AES3	1x XLR ^{1,2}
	AESOP via 2x RJ45 ²
Number of output channels:	
Speaker	2x NL4MD speakON

Audio				
Gain	26 dB	29 dB	32 dB	35 dB
Input sensitivity @ 8 Ω	5.50 V	3.90 V	2.75 V	1.95 V
Max input level	27 dB	24 dB	21 dB	18 dB
Gate	-52 dBu	-55 dBu	-58 dBu	-61 dBu
Frequency Response (±0.5 dB , 1 W @ 8 Ω)	20 Hz - 20 kHz			
Crosstalk (1 kHz)	> 66 dB			
S/N ratio (20 Hz - 20 kHz A-Weighted @ 8 Ω)	> 110 dB			
Input impedance	10 kΩ balanced			
THD+N (from 0.1 W to Full Power)	< 0.5% (typical < 0.05%)			
DIM (from 0.1 W to Full Power)	< 0.5% (typical < 0.05%)			
Slew Rate (input filter bypassed @ 8 Ω)	> 50 V/μs			
Damping Factor @ 8 Ω, 20 Hz - 200 Hz	> 5000			

DSP ³	
AD converters	24 Bit Tandem™ @ 96 kHz 127 dB-A Dynamic Range - 0.005 % THD+N
DA converters	24 Bit Tandem™ @ 192 kHz 122 dB-A Dynamic Range - 0.003 % THD+N
Sample rate converter	24 Bit @ 44.1 kHz to 192 kHz 140 dB Dynamic Range - 0.0001 % THD+N
Internal precision	40 bit floating point
Latency	6.0 ms fixed latency architecture
Memory/Presets	8 MB (RAM) plus 2 MB flash for presets: 50 stored locally + 150 stored on SmartCard
Delay	4 s (input) + 32 ms (output) for time alignment
Equalizer	Raised-cosine, custom FIR, parametric IIR: peaking, hi/lo-shelving, all-pass, band-pass, band-stop, hi/lo-pass
Crossover	linear phase (FIR), hybrid (FIR-IIR), Butterworth, Linkwitz-Riley, Bessel: 6 dB/oct to 48 dB/oct (IIR)
Limiters	TruePower™, RMS voltage, RMS current, Peak limiter
Damping control	Active DampingControl™ and LiveImpedance™ measurement

Networking	
Standards compliance	RS-485 serial connection or auto-sensing 10/100 Mbps UTP ports + AESOP ²
Supported topologies	star, daisy-chain, closed loop ²
Remote interface	Armonia Pro Audio Suite™
Ports	
Non AESOP models	Rear: 1 x RJ45 (RS-485 + V Ext)
2 port AESOP ² models	Front: 2 x RJ45 (Ethernet + AESOP connection)
4 port AESOP ² models	Front: 2 x RJ45 (Ethernet) Rear: 2 x RJ45 (Ethernet + AESOP connection)
Auxiliary supply ³	12 V / 1 A max for DSP management and remote on/off via RJ45 or 2 pin Phoenix ² MCV 1,5/ 2-G-3,81

Output Stage	
Maximum output power per channel @ 8 Ω	1500 W
Maximum output power per channel @ 4 Ω	3000 W
Maximum output power per channel @ 2 Ω	4800 W
Maximum output power @ 8 Ω Bridged	6000 W
Maximum output power @ 4 Ω Bridged	9600 W
Peak total output, all channels driven	9600 W
Maximum unclipped output voltage	169 V _{peak}
Maximum output current	125 A _{peak}

The power figure is calculated by driving and loading symmetrically all the channels: uneven loads allow to achieve highest performance.

AC Mains Power				
Power supply	Universal regulated switch more with PFC			
Nominal voltage (±10%)	100-240 V @ 50-60Hz			
Power factor (> 500 W output)	> 0.95			
Consumption/current draw	@ 115 V	@ 230 V		
Idle	91 W	1.3 A	84 W	1.17 A
1/8 Max Output Power @ 4 Ω	938 W	9.5 A	938 W	4.8 A
1/4 Max Output Power @ 4 Ω	875 W	17.4 A	1875 W	8.7 A
AC Mains connector	AMP CPC 45A connector - 45 A max (region-specific power cord provided)			

Thermal		
Operating temperature	0° - 45° C / 32° - 113° F	
Cooling	Fan, continuously variable speed, temperature controlled, front to rear airflow	
Thermal dissipation		
Idle	546 BTU/h	137.6 kcal/h
1/8 Max Output Power @ 4 Ω	1069 BTU/h	269.4 kcal/h
1/4 Max Output Power @ 4 Ω	1593 BTU/h	401.4 kcal/h

Construction	
Dimensions	483 mm x 44.5 mm x 475 mm (19.0 in x 1.8 in x 18.7 in)
Weight	12 kg (26.5 lb)

¹ Common to channel 2 XLR analog input, either analog or AES3 depending on system configuration.

² Available only in KAESOP equipped models.

³ Only for KDSP equipped model

K6, K6 DSP+AESOP

Channel Handling	
Number of output channels	2 mono, bridgeable per ch. pair
Number of input channels:	
Analog	2x Combo XLR/TRS
AES3	1x XLR ^{1,2}
	AESOP via 2x RJ45 ²
Number of output channels:	
Speaker	2x NL4MD speakON

Audio				
Gain	26 dB	29 dB	32 dB	35 dB
Input sensitivity @ 8 Ω	5.11 V	3.62 V	2.56 V	1.81 V
Max input level	27 dBu	24 dBu	21 dBu	18 dBu
Gate	-52 dBu	-55 dBu	-58 dBu	-61 dBu
Frequency Response (±0.5 dB , 1 W @ 8 Ω)	20 Hz - 20 kHz			
Crosstalk (1 kHz)	> 66 dB			
S/N ratio (20 Hz - 20 kHz A-Weighted @ 8 Ω)	> 110 dB			
Input impedance	10 kΩ balanced			
THD+N (from 0.1 W to Full Power)	< 0.5% (typical < 0.05%)			
DIM (from 0.1 W to Full Power)	< 0.5% (typical < 0.05%)			
Slew Rate (input filter bypassed @ 8 Ω)	> 50 V/μs			
Damping Factor @ 8 Ω, 20 Hz - 200 Hz	> 5000			

DSP ³	
AD converters	24 Bit Tandem™ @ 96 kHz 127 dB-A Dynamic Range - 0.005 % THD+N
DA converters	24 Bit Tandem™ @ 192 kHz 122 dB-A Dynamic Range - 0.003 % THD+N
Sample rate converter	24 Bit @ 44.1 kHz to 192 kHz 140 dB Dynamic Range - 0.0001 % THD+N
Internal precision	40 bit floating point
Latency	6.0 ms fixed latency architecture
Memory/Presets	8 MB (RAM) plus 2 MB flash for presets: 50 stored locally + 150 stored on SmartCard
Delay	4 s (input) + 32 ms (output) for time alignment
Equalizer	Raised-cosine, custom FIR, parametric IIR: peaking, hi/lo-shelving, all-pass, band-pass, band-stop, hi/lo-pass
Crossover	linear phase (FIR), hybrid (FIR-IIR), Butterworth, Linkwitz-Riley, Bessel: 6 dB/oct to 48 dB/oct (IIR)
Limiters	TruePower™, RMS voltage, RMS current, Peak limiter
Damping control	Active DampingControl™ and LiveImpedance™ measurement

Networking	
Standards compliance	RS-485 serial connection or auto-sensing 10/100 Mbps UTP ports + AESOP ²
Supported topologies	star, daisy-chain, closed loop ²
Remote interface	Armonia Pro Audio Suite™
Ports	
Non AESOP models	Rear: 1 x RJ45 (RS-485 + V Ext)
2 port AESOP ² models	Front: 2 x RJ45 (Ethernet + AESOP connection)
4 port AESOP ² models	Front: 2 x RJ45 (Ethernet) Rear: 2 x RJ45 (Ethernet + AESOP connection)
Auxiliary supply ³	12 V / 1 A max for DSP management and remote on/off via RJ45 or 2 pin Phoenix ² MCV 1,5/ 2-G-3,81

Output Stage	
Maximum output power per channel @ 8 Ω	1300 W
Maximum output power per channel @ 4 Ω	2500 W
Maximum output power per channel @ 2 Ω	3600 W
Maximum output power @ 8 Ω Bridged	5000 W
Maximum output power @ 4 Ω Bridged	7200 W
Peak total output, all channels driven	7200 W
Maximum unclipped output voltage	153 V _{peak}
Maximum output current	125 A _{peak}

The power figure is calculated by driving and loading symmetrically all the channels: uneven loads allow to achieve highest performance.

AC Mains Power				
Power supply	Universal regulated switch more with PFC			
Nominal voltage (±10%)	100-240 V @ 50-60Hz			
Power factor (> 500 W output)	> 0.95			
Consumption/current draw	@ 115 V	@ 230 V		
Idle	91 W	1.3 A	84 W	1.17 A
1/8 Max Output Power @ 4 Ω	781 W	8.2 A	781 W	4.1 A
1/4 Max Output Power @ 4 Ω	1563 W	14.8 A	1563 W	7.4 A
AC Mains connector	AMP CPC 45A connector - 45 A max (region-specific power cord provided)			

Thermal	
Operating temperature	0° - 45° C / 32° - 113° F
Cooling	Fan, continuously variable speed, temperature controlled, front to rear airflow
Thermal dissipation	
Idle	546 BTU/h 137.6 kcal/h
1/8 Max Output Power @ 4 Ω	982 BTU/h 247.5 kcal/h
1/4 Max Output Power @ 4 Ω	1419 BTU/h 357.6 kcal/h

Construction	
Dimensions	483 mm x 44.5 mm x 475 mm (19.0 in x 1.8 in x 18.7 in)
Weight	12 kg (26.5 lb)

¹ Common to channel 2 XLR analog input, either analog or AES3 depending on system configuration.

² Available only in KAESOP equipped models.

³ Only for KDSP equipped model

K3, K3 DSP+AESOP

Channel Handling	
Number of output channels	2 mono, bridgeable per ch. pair
Number of input channels:	
Analog	2x Combo XLR/TRS
AES3	1x XLR ^{1,2}
	AESOP via 2x RJ45 ²
Number of output channels:	
Line out (through)	2x XLR
Speaker	2x NL4MD speakON

Audio				
Gain	26 dB	29 dB	32 dB	35 dB
Input sensitivity @ 8 Ω	5.30 V	3.75 V	2.66 V	1.88 V
Max input level	27 dB	24 dB	21 dB	18 dB
Gate	-52 dBu	-55 dBu	-58 dBu	-61 dBu
Frequency Response (±0.5 dB, 1 W @ 8 Ω)	20 Hz - 20 kHz			
Crosstalk (1 kHz)	> 70 dB			
S/N ratio (20 Hz - 20 kHz A-Weighted @ 8 Ω)	> 106 dB			
Input impedance	10 kΩ balanced			
THD+N (from 0.1 W to Full Power)	< 0.3% (typical < 0.05%)			
DIM (from 0.1 W to Full Power)	< 0.3% (typical < 0.05%)			
Slew Rate (input filter bypassed @ 8 Ω)	> 50 V/μs			
Damping Factor @ 8 Ω, 20 Hz - 200 Hz	> 5000			

DSP ³	
AD converters	24 Bit Tandem™ @ 96 kHz 127 dB-A Dynamic Range - 0.005 % THD+N
DA converters	24 Bit Tandem™ @ 192 kHz 122 dB-A Dynamic Range - 0.003 % THD+N
Sample rate converter	24 Bit @ 44.1 kHz to 192 kHz 140 dB Dynamic Range - 0.0001 % THD+N
Internal precision	40 bit floating point
Latency	6.0 ms fixed latency architecture
Memory/Presets	8 MB (RAM) plus 2 MB flash for presets: 50 stored locally + 150 stored on SmartCard
Delay	4 s (input) + 32 ms (output) for time alignment
Equalizer	Raised-cosine, custom FIR, parametric IIR: peaking, hi/lo-shelving, all-pass, band-pass, band-stop, hi/lo-pass
Crossover	linear phase (FIR), hybrid (FIR-IIR), Butterworth, Linkwitz-Riley, Bessel: 6 dB/oct to 48 dB/oct (IIR)
Limiters	TruePower™, RMS voltage, RMS current, Peak limiter
Damping control	Active DampingControl™ and LiveImpedance™ measurement

Networking	
Standards compliance	RS-485 serial connection or auto-sensing 10/100 Mbps UTP ports + AESOP ²
Supported topologies	star, daisy-chain, closed loop ²
Remote interface	Armonía Pro Audio Suite™
Ports	
Non AESOP models	Rear: 1 x RJ45 (RS-485 + V Ext)
2 port AESOP ² models	Front: 2 x RJ45 (Ethernet + AESOP connection)
4 port AESOP ² models	Front: 2 x RJ45 (Ethernet) Rear: 2 x RJ45 (Ethernet + AESOP connection)
Auxiliary supply ³	12 V / 1 A max for DSP management and remote on/off via RJ45 or 2 pin Phoenix ² MCV 1,5/ 2-G-3,81

Output Stage	
Maximum output power per channel @ 8 Ω	1400 W
Maximum output power per channel @ 4 Ω	2600 W
Maximum output power per channel @ 2 Ω	2800 W
Maximum output power @ 8 Ω Bridged	5200 W
Maximum output power @ 4 Ω Bridged	5600 W
Peak total output, all channels driven	5600 W
Maximum unclipped output voltage	165 V _{peak}
Maximum output current	102 A _{peak}

The power figure is calculated by driving and loading symmetrically all the channels: uneven loads allow to achieve highest performance.

AC Mains Power				
Power supply	Universal regulated switch more with PFC			
Nominal voltage (±10%)	100-240 V @ 50-60Hz			
Power factor (> 500 W output)	> 0.95			
Consumption/current draw	@ 115 V	@ 230 V		
Idle	64 W	1.12 A	75 W	1.3 A
1/8 Max Output Power @ 4 Ω	813 W	8 A	813 W	4 A
1/4 Max Output Power @ 4 Ω	1625 W	14.8 A	1625 W	7.4 A
AC Mains connector	AMP CPC 45A connector - 45 A max (region-specific power cord provided)			

Thermal	
Operating temperature	0° - 45° C / 32° - 113° F
Cooling	Fan, continuously variable speed, temperature controlled, front to rear airflow
Thermal dissipation	
Idle	382 BTU/h 96.3 kcal/h
1/8 Max Output Power @ 4 Ω	836 BTU/h 210.7 kcal/h
1/4 Max Output Power @ 4 Ω	1390 BTU/h 350.3 kcal/h

Construction	
Dimensions	483 mm x 44.5 mm x 380 mm (19.0 in x 1.8 in x 15 in)
Weight	8 kg (17.7 lb)

¹ Common to channel 2 XLR analog input, either analog or AES3 depending on system configuration.

² Available only in KAESOP equipped models.

³ Only for KDSP equipped model

K2, K2 DSP+AESOP

Channel Handling	
Number of output channels	2 mono, bridgeable per ch. pair
Number of input channels:	
Analog	2x Combo XLR/TRS
AES3	1x XLR ^{1,2}
	AESOP via 2x RJ45 ²
Number of output channels:	
Line out (through)	2x XLR
Speaker	2x NL4MD speakON

Audio				
Gain	26 dB	29 dB	32 dB	35 dB
Input sensitivity @ 8 Ω	4.48 V	3.17 V	2.47 V	1.59 V
Max input level	27 dB	24 dB	21 dB	18 dB
Gate	-52 dBu	-55 dBu	-58 dBu	-61 dBu
Frequency Response (±0.5 dB, 1 W @ 8 Ω)	20 Hz - 20 kHz			
Crosstalk (1 kHz)	> 70 dB			
S/N ratio (20 Hz - 20 kHz A-Weighted @ 8 Ω)	> 106 dB			
Input impedance	10 kΩ balanced			
THD+N (from 0.1 W to Full Power)	< 0.2% (typical < 0.05%)			
DIM (from 0.1 W to Full Power)	< 0.2% (typical < 0.05%)			
Slew Rate (input filter bypassed @ 8 Ω)	> 50 V/μs			
Damping Factor @ 8 Ω, 20 Hz - 200 Hz	> 5000			

DSP ³	
AD converters	24 Bit Tandem™ @ 96 kHz 127 dB-A Dynamic Range - 0.005 % THD+N
DA converters	24 Bit Tandem™ @ 192 kHz 122 dB-A Dynamic Range - 0.003 % THD+N
Sample rate converter	24 Bit @ 44.1 kHz to 192 kHz 140 dB Dynamic Range - 0.0001 % THD+N
Internal precision	40 bit floating point
Latency	6.0 ms fixed latency architecture
Memory/Presets	8 MB (RAM) plus 2 MB flash for presets: 50 stored locally + 150 stored on SmartCard
Delay	4 s (input) + 32 ms (output) for time alignment
Equalizer	Raised-cosine, custom FIR, parametric IIR: peaking, hi/lo-shelving, all-pass, band-pass, band-stop, hi/lo-pass
Crossover	linear phase (FIR), hybrid (FIR-IIR), Butterworth, Linkwitz-Riley, Bessel: 6 dB/oct to 48 dB/oct (IIR)
Limiters	TruePower™, RMS voltage, RMS current, Peak limiter
Damping control	Active DampingControl™ and LiveImpedance™ measurement

Networking	
Standards compliance	RS-485 serial connection or auto-sensing 10/100 Mbps UTP ports + AESOP ²
Supported topologies	star, daisy-chain, closed loop ²
Remote interface	Armonia Pro Audio Suite™
Ports	
Non AESOP models	Rear: 1 x RJ45 (RS-485 + V Ext)
2 port AESOP ² models	Front: 2 x RJ45 (Ethernet + AESOP connection)
4 port AESOP ² models	Front: 2 x RJ45 (Ethernet) Rear: 2 x RJ45 (Ethernet + AESOP connection)
Auxiliary supply ³	12 V / 1 A max for DSP management and remote on/off via RJ45 or 2 pin Phoenix ² MCV 1,5/ 2-G-3,81

Output Stage	
Maximum output power per channel @ 8 Ω	1000 W
Maximum output power per channel @ 4 Ω	1950 W
Maximum output power per channel @ 2 Ω	2400 W
Maximum output power @ 8 Ω Bridged	3900 W
Maximum output power @ 4 Ω Bridged	4800 W
Peak total output, all channels driven	4800 W
Maximum unclipped output voltage	140 V _{peak}
Maximum output current	102 A _{peak}

The power figure is calculated by driving and loading symmetrically all the channels: uneven loads allow to achieve highest performance.

AC Mains Power				
Power supply	Universal regulated switch more with PFC			
Nominal voltage (±10%)	100-240 V @ 50-60Hz			
Power factor (> 500 W output)	> 0.95			
Consumption/current draw	@ 115 V	@ 230 V		
Idle	69 W	1.2 A	88 W	1.35 A
1/8 Max Output Power @ 4 Ω	609 W	6.3 A	609 W	3.1 A
1/4 Max Output Power @ 4 Ω	1219 W	11.4 A	1219 W	5.7 A
AC Mains connector	AMP CPC 45A connector - 45 A max (region-specific power cord provided)			

Thermal	
Operating temperature	0° - 45° C / 32° - 113° F
Cooling	Fan, continuously variable speed, temperature controlled, front to rear airflow
Thermal dissipation	
Idle	382 BTU/h 96.3 kcal/h
1/8 Max Output Power @ 4 Ω	722 BTU/h 181.9 kcal/h
1/4 Max Output Power @ 4 Ω	1062 BTU/h 267.6 kcal/h

Construction	
Dimensions	483 mm x 44.5 mm x 380 mm (19.0 in x 1.8 in x 15 in)
Weight	8 kg (17.7 lb)

¹ Common to channel 2 XLR analog input, either analog or AES3 depending on system configuration.

² Available only in KAESOP equipped models.

³ Only for KDSP equipped model

Page intentionally left blank



Powersoft S.p.A.
Via Enrico Conti, 5
50018 Scandicci (FI) Italy

Tel: +39 055 735 0230
Fax: +39 055 735 6235

General inquiries: info@powersoft.it
Sales: sales@powersoft.it
Application & technical support: support@powersoft.it
Service & maintenance: service@powersoft.it
Compliance questions: compliance@powersoft.it

powersoft-audio.com