



MOBILEMIX

8-CHANNEL USB-POWERABLE MIXER FOR A/V PRODUCTION,
LIVE SOUND & STREAMING

OWNER'S MANUAL



Important Safety Instructions

1. Read these instructions.
2. Keep these instructions.
3. Heed all warnings.
4. Follow all instructions.
5. Do not use this apparatus near water.
6. Clean only with a dry cloth.
7. Do not block any ventilation openings.
Install in accordance with the manufacturer's instructions.
8. Minimum distance (5 cm) around the apparatus for sufficient ventilation.
The ventilation should not be impeded by covering the ventilation openings with items, such as newspapers, tablecloths, curtains, etc.
9. Do not install near any heat sources such as radiators, heat registers, stoves, or other apparatus (including amplifiers) that produce heat.
10. No naked flame sources, such as lighted candles, should be placed on the apparatus.
11. Protect the power cord from being walked on or pinched particularly at plugs, convenience receptacles, and the point where they exit from the apparatus.
12. Only use attachments/accessories specified by the manufacturer.
13. Unplug this apparatus during lightning storms or when unused for long periods of time.
14. Refer all servicing to qualified service personnel. Servicing is required when the apparatus has been damaged in any way, such as power-supply cord or plug is damaged, liquid has been spilled or objects have fallen into the apparatus, the apparatus has been exposed to rain or moisture, does not operate normally, or has been dropped.
15. This apparatus shall not be exposed to dripping or splashing, and no object filled with liquids, such as vases or beer glasses, shall be placed on the apparatus.
16. Operating Temperature: 0°–45° C // 32–113° F
17. Bluetooth frequency range: 2400–2483.5 MHz
Bluetooth transmitter modulation: GFSK, π /4-DQPSK, 8-DPSK
18. This device complies with Part 15 of the FCC Rules [and contains license-exempt transmitter(s)/receiver(s) that comply with Innovation, Science and Economic Development Canada's license-exempt RSS standard(s)].
Operation is subject to the following two conditions:
(1) This device may not cause harmful interference, and
(2) This device must accept any interference received, including interference that may cause undesired operation of the device.
L'émetteur/récepteur exempt de licence contenu dans le présent appareil est conforme aux CNR d'Innovation, Sciences et Développement économique Canada applicables aux appareils radio exempts de licence.
L'exploitation est autorisée aux deux conditions suivantes:
(1) L'appareil ne doit pas produire de brouillage, et
(2) L'appareil doit accepter tout brouillage radioélectrique subi, même si le brouillage est susceptible d'en compromettre le fonctionnement.

WARNING — To reduce the risk of fire or electric shock, do not expose this apparatus to rain or moisture.

This is not a warning or an important safety instruction. It is an Easter Egg for anyone looking for one. Hi!

- 19. NOTE:** This equipment has been tested and found to comply with the limits for a Class B digital device, pursuant to part 15 of the FCC Rules. These limits are designed to provide reasonable protection against harmful interference in a residential installation. This equipment generates, uses, and can radiate radio frequency energy and, if not installed and used in accordance with the instructions, may cause harmful interference to radio communications. However, there is no guarantee that interference will not occur in a particular installation. If this equipment does cause harmful interference to radio or television reception, which can be determined by turning the equipment off and on, the user is encouraged to try to correct the interference by one or more of the following measures:
- Reorient or relocate the receiving antenna.
 - Increase the separation between the equipment and the receiver.
 - Connect the equipment into an outlet on a circuit different from that to which the receiver is connected.
 - Consult the dealer or an experienced radio/TV technician for help.

CAUTION: Changes or modifications to this device not expressly approved by LOUD Audio, LLC. could void the user's authority to operate the equipment under FCC rules.

- 20.** This apparatus does not exceed the Class B limits for radio noise emissions from digital apparatus as set out in the radio interference regulations of the Canadian Department of Communications. CAN ICES-003(B)/NMB-003(B)
ATTENTION — *Le présent appareil numérique n'émet pas de bruits radioélectriques dépassant les limites applicables aux appareils numériques de class B prescrites dans le règlement sur le brouillage radioélectrique édicté par les ministere des communications du Canada.*
- 21.** This equipment complies with FCC and ISED radiation exposure limits set forth for an uncontrolled environment. This equipment should be installed and operated with minimum distance of 20cm between the radiator & your body.
- 22.** Exposure to extremely high noise levels may cause permanent hearing loss. Individuals vary considerably in susceptibility to noise-induced hearing loss, but nearly everyone will lose some hearing if exposed to sufficiently intense noise for a period of time. The U.S. Government's Occupational Safety and Health Administration (OSHA) has specified the permissible noise level exposures shown in the following chart. According to OSHA, any exposure in excess of these permissible limits could result in some hearing loss. To ensure against potentially dangerous exposure to high sound pressure levels, it is recommended that all persons exposed to equipment capable of producing high sound pressure levels use hearing protectors while the equipment is in operation. Ear plugs or protectors in the ear canals or over the ears must be worn when operating the equipment in order to prevent permanent hearing loss if exposure is in excess of the limits set forth here:

Duration, per day in hours	Sound Level dBA, Slow Response	Typical Example
8	90	Duo in small club
6	92	
4	95	Subway Train
3	97	
2	100	Very loud classical music
1.5	102	
1	105	Chaz screaming at Troy about deadlines
0.5	110	
0.25 or less	115	Loudest parts at a rock concert



Correct disposal of this product: This symbol indicates that this product should not be disposed of with your household waste, according to the WEEE directive (2012/19/EU) and your national law. This product should be handed over to an authorized collection site for recycling waste electrical and electronic equipment (EEE). Improper handling of this type of waste could have a possible negative impact on the environment and human health due to potentially hazardous substances that are generally associated with EEE. At the same time, your cooperation in the correct disposal of this product will contribute to the effective usage of natural resources. For more information about where you can drop off your waste equipment for recycling, please contact your local city office, waste authority, or your household waste disposal service.

Table of Contents

Important Safety Instructions.....2

Table of Contents3

Chapter 1 : Welcome.....5

Introduction.....5
Features5
Things to Remember.....5
About This Guide6
Getting Started.....6

Chapter 2 : MobileMix Rear Panel Features7

Introduction.....7
USB-C Power Connector7
Power Switch.....7
XLR and 1/4" Combo Input Jacks [Channels 1 and 2].....8
1/4" Stereo Line Input Jacks [Channel 3/4]9
1/8" (Secondary) Stereo Line Input Jack [Channel 5/6]9
1/4" Mix 1 and Mix 2 Output Jacks.....9
1/4" Main Output Jacks.....10

Chapter 3 : MobileMix Top Panel Features.....11

Introduction.....11
Gain Knobs11
 "U" Like Unity Gain.....11
Line / Hi-Z Switches [Channels 1 and 2]12
Low Cut Switches [Channels 1 and 2]12
Channel Equalization (EQ)13
 Hi EQ Knobs.....13
 Low EQ Knobs13
FX Knobs14
Channel Level Knobs.....14

Bluetooth Switch and LED [Channel 7/8]	15
1/8" Headphone Output Jack	15
1/8" (Primary) Input Jack and Pad Switch	16
Primary Level Knob	16
Mix 1 and Mix 2 Level Knobs	16
The Great Outdoors Switches	16
Blend Knob	17
Power LED	17
48V Phantom Power Switch and LED	17
FX Select Switch	18
Master FX Level Knob	18
Phones Knob	18
Main Mix Level Knob	18
Main Meters	19
Battery Operation	19
Angled Phone / Tablet Slot	21

Hookup Diagrams **22**

Hookup Diagrams > Camping	22
Hookup Diagrams > Live Streaming	23

Appendix A : Service Information..... **24**

Troubleshooting	24
Repair	25

Appendix B : Technical Information..... **26**

Specifications	26
MobileMix Dimensions	28
MobileMix Block Diagram	29

Warranty Statement **30**

Chapter 1 : Welcome

Introduction

Hello everyone! This is the MobileMix Owner's Manual. This document contains detailed information about the MobileMix hardware... we hope you like it!

MobileMix is a fully featured small audio mixer that brings legendary Mackie sound to DSLR cameras, PA systems and smartphone streaming setups.

From on-the-go live sound, to live streaming with your phone, to video production, MobileMix delivers professional quality in an analog mixer you can use anywhere. Professional mic and instrument inputs, bi-directional Bluetooth® with Mix Minus and more ensure you can connect anything that your project needs. Onboard processing makes it easy to send production-quality sound directly to multiple devices and speakers at the same time.

And since MobileMix is powerable by USB, you can connect it to an external battery that stashes underneath, creating a rechargeable mini mixer that easily travels with you.

So there you have it. Again, we hope you like it. If you have any questions or comments about this Owner's Manual (or other Mackie documentation), please don't hesitate to contact us:

- 1-800-898-3211 (Monday through Friday, normal business hours, Pacific Time)
- www.mackie.com/support-contact

Features

- Runs on USB power from rechargeable batteries, adapters and powered USB ports
- Dedicated mix output for recording to smartphones, tablets and DSLR cameras
- Bluetooth® input/output with Mix Minus technology for recording and streaming at same time, including phone calls without echo
- 2 mic/instrument inputs with XLR and 1/4" combo connectors, Hi-Z, low cut and 48V phantom power
- Stereo input for keyboards and other line-level gear
- Two-way TRRS connector for second smart device or camera
- 3 different Reverb types with level controls per channel
- 2 mix outputs with separate level controls for PA systems, monitors and more
- Headphone output with level control
- Compartment for USB battery (sold separately)

Things to Remember

- Never listen to loud music for prolonged periods.
Please see the Safety Instructions on page 2 for information on hearing protection.
- As a general guide, the MobileMix should be turned on first, subwoofers next, and the loudspeakers last. As such, the loudspeakers should also be turned off first, followed by the subwoofers, then the MobileMix. This will reduce the possibility of any turn-on or turn-off thumps and other noises generated by any upstream equipment from coming out of the speakers.
- Save the shipping boxes and packing materials! You may need them someday. Besides, the cats will love playing in them and jumping out at you unexpectedly. Remember to pretend like you are surprised!
- Save your sales receipt in a safe place.

About This Guide

This guide is designed to be accessible, with subsections as complete as practical to minimize having to electronically leaf back and forth looking for the whole story. The entire guide does not need to be read to figure out how to use this console.

As the saying goes, “a picture tells a 1000 words”. With that thought in mind, we added quite a few illustrations, screenshots and other images throughout to accompany the text.



This icon marks information that is critically important or unique! For your own good, read and remember them.



There's an illustration of a microscope, so, of course, you're going to get more detailed information when you see this little guy. There are explanations of features and practical tips listed here.



It's a good idea to pay attention to text displayed next to a note icon, as this icon draws attention to certain features and functions relating to the usage of MobileMix.

Getting Started

The following steps will help you set up the MobileMix quickly. If you desire a more thorough walk-through of MobileMix, there is a wealth of information in the following pages!

1. Read and understand the Important Safety Instructions on page 2.
2. Turn down all knobs except the channel EQ.
3. Set all channel EQ knobs at their center detent.
4. Disengage all switches.
5. Connect cords from the main outs to powered speakers.
6. Plug signal sources into the mixer, such as:
 - Microphones plugged into the mic inputs. (Engage phantom power if needed.)
 - Instrument level sources, such as acoustic guitars w/active pickups into the instrument inputs
 - Line-level sources such as keyboards, drum machines, or CD players plugged into the line-level inputs.
 - Smartphone paired and connected via Bluetooth.
7. Connect a power adapter (USB or wall-wart) or portable power bank to the power connector.
There is also a hidden compartment on the bottom of the mixer to place a battery. Read more about it on pages 19-21.
8. Turn the mixer on.
9. Turn the powered speakers on.
10. Be sure that the volume of the input is the same as it would be during normal use.
11. Rotate the channel 1 gain and level knobs to the “U” (unity gain) position.
12. Slowly bring up the main knob to a comfortable listening level.
13. Repeat steps 10 and 11 for the other channels.

Chapter 2 : MobileMix Rear Panel Features



Introduction

The top panel of MobileMix may be where all the magic happens, but nothing will happen if it can't be powered up, so let's start there! The rear panel of each MobileMix is outfitted with a power connector, a power switch, and a variety of input and output choices. Let's take a look at each of these features, starting with the power connector and power switch, followed by a look at the combo jacks then working our way back left.

USB-C Power Connector

The MobileMix may be powered in multiple ways:

- (1) This is a standard USB-C power connector. Connect the USB-C side of the detachable power cord (included in the packaging) to this jack and plug the other end of the power cord into a live AC outlet.
- (2) This is a standard USB-C power connector. Connect the USB-C side of a detachable power cord to this jack and plug the other end of the power cord into a USB-A slot (whether it's a computer or USB hub).
- (3) This same USB-C power connector is also inside MobileMix. Yes, inside! It is powered via portable battery. It may be accessed by lifting the battery compartment cover from the bottom of MobileMix. There is more information on pages 19-21.

Power Switch

Located just above the USB-C power connector is the power switch. It's a solid green circle, you can't miss it! Press this rocker switch in to turn the MobileMix on and press it again to turn it off. The LED on the front panel will illuminate green when MobileMix is powered up.

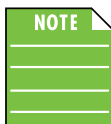

As a general guide, MobileMix should be turned on first, followed by external power amplifiers or powered speakers. As such, MobileMix should also be turned off last. This will reduce the possibility of any turn-on or turn-off thumps in the PA.

XLR and 1/4" Combo Input Jacks [Channels 1 and 2]

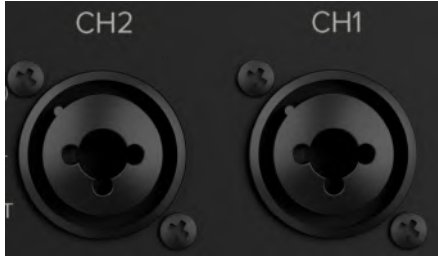

The first two input channels may accept a balanced mic or line-level signal using an XLR connector. They are wired as follows, according to standards specified by the AES (Audio Engineering Society).

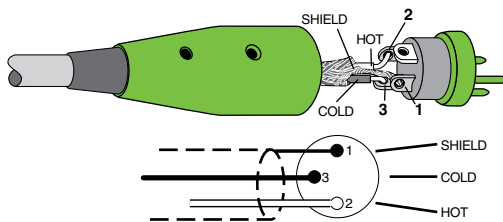

XLR Balanced Wiring:

- Pin 1 = Shield (ground)
- Pin 2 = Positive (+ or hot)
- Pin 3 = Negative (- or cold)

In addition to accepting balanced mic or line-level signals using an XLR connector, these inputs may also accept 1/4" line-level signals driven by balanced or unbalanced sources.

To connect balanced lines to these inputs, use a 1/4" Tip-Ring-Sleeve (TRS) plug. "TRS" stands for Tip-Ring-Sleeve, the three connection points available on a stereo 1/4" or balanced phone jack or plug. TRS jacks and plugs are used for balanced signals and stereo headphones and are wired as follows:

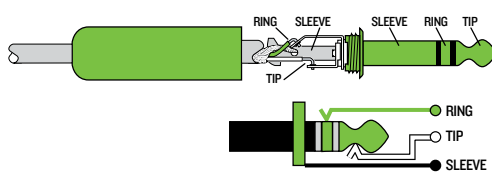

1/4" TRS Balanced Mono Wiring:

- Sleeve = Shield
- Tip = Hot (+)
- Ring = Cold (-)

To connect unbalanced lines to these inputs, use a 1/4" mono (TS) phone plug, wired as follows:

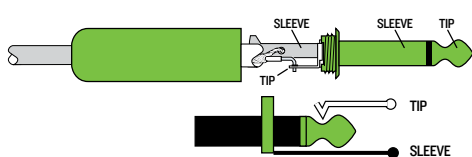

1/4" TS Unbalanced Mono Wiring:

- Sleeve = Shield
- Tip = Hot (+)



NEVER connect the output of an amplifier directly to a MobileMix's input jack. This could damage the input circuitry and we wouldn't want that now, would we?

1/4" Stereo Line Input Jacks [Channel 3/4]



The stereo line inputs are designed for 1/4" TRS balanced or 1/4" TS unbalanced signals. They may accept any line-level instrument, effects device, CD player, etc.

If you are connecting a mono source, use the left (mono) input, and the mono signals will appear on both sides of the main mix.

To connect balanced lines to these inputs, use a 1/4" Tip-Ring-Sleeve (TRS) plug. To connect unbalanced lines to these inputs, use a 1/4" mono (TS) phone plug. The wiring diagrams were presented on the previous page.



NEVER connect the output of an amplifier directly to a MobileMix's input jack. This could damage the input circuitry and we wouldn't want that now, would we?

1/8" (Secondary) Stereo Line Input Jack [Channel 5/6]



Connect an additional phone, tablet, or DSLR camera to this connector using an 1/8" TRRS cable. This connector will also allow the main mix – minus this channel – to be sent back to a secondary phone connected to this input.

The volume is controlled via the channel 5/6 level knob.

1/4" Mix 1 and Mix 2 Output Jacks



These 1/4" jacks may accept almost any additional output such as an extra pair of headphones (or a headphone distribution amplifier), an external recorder, and more. The volume of these jacks are raised and lowered via the Mix level knobs.



WARNING: The Mix 1 and Mix 2 amps are loud and can cause permanent hearing damage. Even intermediate levels may be painfully loud with some headphones. **BE CAREFUL!** Always turn the Mix 1 and Mix 2 level controls all the way down before connecting headphones or doing anything new that may affect the headphone volume. Then turn it up slowly as you listen carefully.

1/4" Main Output Jacks



The main outputs provide a line-level signal that represents the end of the mixer chain, where the fully mixed stereo signal enters the real world. Connect these to the left and right inputs of your main power amplifiers, powered speakers, or serial effects processor (like a graphic equalizer or compressor/limiter).

The main outputs may accept 1/4" connectors driven by balanced or unbalanced sources.

To connect balanced lines to these outputs, use a 1/4" Tip-Ring-Sleeve (TRS) plug. "TRS" stands for Tip-Ring-Sleeve, the three connection points available on a stereo 1/4" or balanced phone jack or plug. TRS jacks and plugs are used for balanced signals and are wired as follows:

1/4" TRS Balanced Mono Wiring:

Sleeve = Shield

Tip = Hot (+)

Ring = Cold (-)

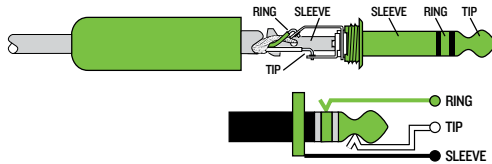

To connect unbalanced lines to these outputs, use a 1/4" mono (TS) phone plug, wired as follows:

1/4" TS Unbalanced Mono Wiring:

Sleeve = Shield

Tip = Hot (+)

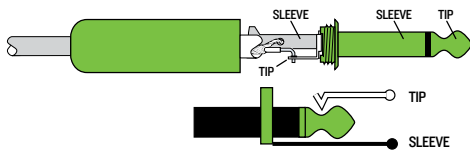

Chapter 3 : MobileMix Top Panel Features



Introduction

From top to bottom and left to right, the top panel of each MobileMix is outfitted with a bunch of knobs, buttons, jacks, and more. So much more, in fact, that we will call out and describe each one...

Gain Knobs

“U” like Unity Gain

MobileMix has a “U” symbol on many level controls. It stands for “unity gain,” meaning no change in signal level. The labels on the controls are measured in decibels (dB), so you’ll know what you’re doing level-wise if you choose to change a control’s settings.



If you haven't already, please read the "Getting Started" section on page 6. Setting the gain correctly will ensure that the preamplifier's gain is not too high, where distortion could occur, and not too low, where the quieter, exquisitely-delicate passages might be lost in background noise.

The gain knobs adjust the input sensitivity of the mic and line inputs. This allows signals from the outside world to be adjusted to run through each channel at optimal internal operating levels.



For mono channels (mic input with a mono line input), the gain knob adjusts the input sensitivity of the mic and line inputs.

If the signal originates through the mic XLR jack, there will be 0 dB of gain with the knob fully down, ramping to 50 dB of gain fully up.

Through the 1/4" mono line inputs, there is -20 dB of attenuation fully down and 30 dB of gain fully up, with unity gain "U" at 12:00.

This 20 dB of attenuation can be very handy when you are inserting a hot signal, or when you want to add EQ gain, or both. Without this "virtual pad," there is more chance of channel clipping.



For stereo channels, the gain knob adjusts the input sensitivity of the 1/4" (Ch. 3/4) and 1/8" (Ch. 5/6) line inputs. The stereo gain control has 20 dB of gain and 20 dB of attenuation.

Line / Hi-Z Switches [Channels 1 and 2]



To connect a guitar or bass directly to the mixer without using a DI Box, press this switch in first; then connect the output from the instrument to the channel's 1/4" TRS input. The input impedance is optimized for direct connection and high-frequency fidelity is assured.

In the out position, the channel's 1/4" TRS input becomes a line input just like the other mono line inputs.

To use guitars or other instruments on other channels, you will need to use an external DI box first. Without the DI box – or if this switch is not pressed in – guitars may sound dull and muddy.

Low Cut Switches [Channels 1 and 2]



Channels 1 and 2 have a low-cut switch (often referred to as a high-pass filter) that cuts bass frequencies below 100 Hz at a rate of 18 dB per octave.

We recommend that you use low-cut on every microphone application except kick drum, bass guitar, or bassy synth patches. These aside, there isn't much down there that you want to hear, and filtering it out makes the low stuff you do want much more crisp and tasty. Not only that, but low-cut can help reduce the possibility of feedback in live situations, and it helps to conserve amplifier power.



Another way to consider low-cut's function is that it actually adds flexibility during live performances. With the addition of low-cut, you can safely use low equalization on vocals. Many times, bass shelving EQ can really benefit voices. Trouble is, adding low EQ also boosts stage rumble, mic handling clunks and breath pops from way-down low. Applying low-cut removes all those problems, so you can add

low EQ without blowing the woofers.

Channel Equalization (EQ)



MobileMix has shelving hi and low EQ knobs on channels 1-4. The 2-band equalization has low shelving at 80 Hz and high shelving at 12 kHz. Shelving means that the circuitry boosts or cuts all frequencies past the specified frequency. For example, the low EQ boosts bass frequencies below 80 Hz and continuing down to the lowest note you never heard.



With too much EQ, you can really upset things. We've designed a lot of boost and cut into each equalizer circuit because we know that everyone will occasionally need that. But if you max the EQ on every channel, you'll get mix mush. Equalize subtly and use the left sides of the knobs (cut), as well as the right (boost). If you find yourself repeatedly using a lot of boost or cut, consider altering the sound source, such as placing a mic differently, trying a different kind of mic, a different vocalist, changing the strings, or gargling.

The EQ circuits are based upon the designs of Cal Perkins, an industry-leader in audio engineering for over four decades and a long-time collaborator. This "neo-classic" design provides the sweet musicality of the British EQ sound, while still maintaining 15 dB of boost and cut with optimum Q and minimum phase shift (in other words, it gives you plenty of control and is pleasing to the ear!).

Hi EQ Knobs

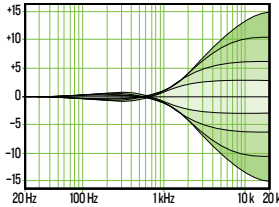

The hi EQ provides up to 15 dB of boost or cut above 12 kHz, and it is also flat (no boost or cut) at the detent. Use it to add sizzle to cymbals, an overall sense of transparency, or an edge to keyboards, vocals, guitar and bacon frying. Turn it down a little to reduce sibilance.

Low EQ Knobs

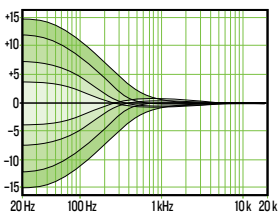

The low EQ provides up to 15 dB of boost or cut below 80 Hz. The circuit is flat at the center detent position. This frequency represents the punch in bass drums, bass guitar, fat synth patches, and some really serious male singers who eat raw beef for breakfast.

FX Knobs



These knobs tap a portion of each channel's signal to set up a nice FX mix feeding the internal FX processor. The FX may be added to the 1/4" main output jacks, the mix 1 and mix 2 output jacks, and the headphones output.

The controls are off when fully turned down, deliver unity gain at the center detent, and can provide up to 10 dB of gain turned fully up (MAX).

The channel level knob and other channel controls affect the FX output, as well. The FX is post-fader.

The FX signal reaching the internal FX processor is the sum (mix) of all the channels whose FX control is set to more than minimum.

The overall output level may be adjusted with the master FX Level knob.

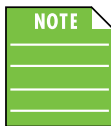

The Ch. 5/6 FX knob is located just below its gain knob.



FX are typically not added to Bluetooth channels. This is why there is no FX knob available on Ch. 7/8.

Channel Level Knobs



This is the last control in a channel's signal path, and it adjusts the level of each channel onto the main mix.

The "U" mark indicates unity gain, meaning no increase or decrease of signal level. All the way up provides an additional 10 dB, should you need to boost a section of a song. If you find that the overall level is too quiet or too loud with the level near unity, check that the gain control is set correctly.

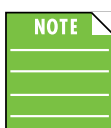

The Ch. 5/6 level knob is located just below its FX knob.

Bluetooth Switch and LED [Channel 7/8]



Mixers can only accept one input per channel and MobileMix is no different. This switch will engage the channel's pairing mode, allowing the mixer to be seen by other Bluetooth devices such as a phone or tablet.

Pairing and Connecting – Press and hold the Bluetooth button to select it. The button will flash blue when selected. This is to indicate that the MobileMix and device are in pairing mode.

While the MobileMix is in pairing mode, simultaneously scan for Bluetooth devices on the phone or tablet. You should see MobileMix appear in the “available devices” list. Select it. From there, the device should indicate that it is successfully connected. Additionally, the LED located above the Bluetooth button on the mixer will be solid blue instead of flashing. If nothing is connected to MobileMix via Bluetooth – or if the MobileMix and device are out of range – then the LED will be solid red.



If Bluetooth is disengaged, then channel 7/8 is unused as it only accepts a Bluetooth connection.



A previously paired device will auto reconnect if both the device and mixer are powered on and in range.



The Bluetooth may disconnect when affected by Electrostatic Discharge [ESD]. Manually reconnect the Bluetooth connection.

1/8" Headphone Output Jack



This 1/8" TRS connector supplies the output to stereo headphones. Here, one is able to listen to a copy of the main mix pre-main level knob. The volume is controlled via the headphones knob.

The phones output follows standard conventions:

Tip = Left channel
Ring = Right channel
Sleeve = Ground



WARNING: The headphone amp is loud and can cause permanent hearing damage. Even intermediate levels may be painfully loud with some headphones. **BE CAREFUL!** Always turn the phones level control all the way down before connecting headphones or doing anything new that may affect the headphone volume.

Then turn it up slowly as you listen carefully.

1/8" (Primary) Input Jack and Pad Switch



Connect a phone, tablet, or DSLR camera to this connector using an 1/8" TRRS cable. The connected device may be used as a line source and/or destination. This jack utilizes standard hands-free protocols, so the phone/tablet interprets MobileMix as a headset and routes the audio appropriately.

Located just below the jack is a pad switch. It determines the primary source, be it a line-level signal (switch disengaged) or phone/camera (switch engaged).

We believe that in the majority of cases, one will use MobileMix for livestreaming, therefore, the phone/camera pad switch would be engaged. However, there will be some of you that would prefer to use this for a line-level connection.

This could be another mixer's output connected to this input, or perhaps an interface for direct recording.

We're just saying that... you have options!

The volume is controlled via the primary level knob (see below).

Primary Level Knob



The level of the primary device connected to the 1/8" input jack (see above) is raised and lowered via this level knob. The control is off when fully turned down and can provide up to 10 dB of gain turned fully up (MAX). The mix is sent to the main outs, headphones out, and mix outs.

Mix 1 and Mix 2 Level Knobs



The level of the Mix 1 and Mix 2 output jacks is raised and lowered via these Mix level knobs. The controls are off when fully turned down and can provide up to 10 dB of gain turned fully up (MAX).

WARNING: The Mix 1 and Mix 2 amps are loud and can cause permanent hearing damage.

Even intermediate levels may be painfully loud with some headphones. **BE CAREFUL!**

Always turn the Mix 1 and Mix 2 level controls all the way down before connecting headphones or doing anything new that may affect the headphone volume.

Then turn it up slowly as you listen carefully.

The Great Outdoors Switches



Located near the upper-right corner of MobileMix – between the Mix Level Knobs and the angled phone/tablet slot – are some momentary switches we dubbed, "The Great Outdoors".

When pressed, a number of outdoor items that you may have left at home are at your disposal: small snacks, candies, and gum/breath mints, ear plugs, ball (to play fetch with the dog), and more... are you outside livestreaming at the beach and forgot the sunblock? Press (and hold) this momentary switch down to get sunscreen.

Campers will have a bevy of options at their disposal, so long as they are small and compact.



These items are only available when using MobileMix... outdoors!

Blend Knob



This knob may be rotated to create a unique blend of inputs 1-8 with the primary source to the outputs.

Use this knob while recording overdubs, for example.

Knob position (L, C, R):

- Full Left – Channels 1-8 = Full Volume
Primary Source = No Volume
- Center – Channels 1-8 and Primary Source = Equal Volume
- Full Right – Channels 1-8 = No Volume
Primary Source = Full Volume



The blend knob is occasionally confused with the “bland” knob, but that knob is for toning down high-energy music, thusly making it bland.

Power LED



This LED will illuminate green when the mixer is turned on, as a reminder of how on it really is. If it is not on, then it is off, and the MobileMix becomes a rather nice weight for keeping your morning newspaper from blowing away in the wind.

If it does not turn on, make sure the power cord is correctly inserted at both ends, the local AC mains supply is active, and the power switch is on. If using a battery, make sure that it has been fully charged, is connected correctly at both ends, and contains the correct specs.

48V Phantom Power Switch and LED



Most modern professional condenser mics require 48V phantom power which lets the mixer send low-current DC voltage to the mic's electronics through the same wires that carry audio. (Semi-pro condenser mics often have batteries to accomplish the same thing.) “Phantom” owes its name to an ability to be “unseen” by dynamic mics (Shure SM57/SM58, for instance), which don't need external power and aren't affected by it anyway.

Press this switch in if your microphone requires phantom power. (Always check the position of this switch before connecting microphones.) The accompanying LED will illuminate white to indicate that phantom power is active. This is a global switch that affects both mic channels' XLR jacks simultaneously.



Never plug single-ended (unbalanced) microphones, or ribbon mics into the mic input jacks if phantom power is on. Do not plug instrument outputs into the mic XLR input jacks with phantom power on unless you know for certain it is safe to do so. Be sure the main mix knob is turned down when connecting microphones to the mic inputs when phantom power is turned on to prevent pops from getting through to the speakers.

FX Select Switch



This is a momentary switch that cycles between three unique FX modes: Plate, Hall, and Reverb + Delay. Simply press this switch to cycle between the FX modes.

Effect	Description
Plate	This effect emulates vintage mechanical reverberation that was generated with a metal plate. Its sound is characterized by lots of early reflections and no pre-delay.
Hall	This reverb simulates the sound of a spacious, yet cozy, heavily draped and carpeted concert hall with an especially warm tone.
Reverb + Delay	This is a spring reverb with delay added. Spring reverbs use a transducer at one end of a spring and a pickup at the other end to create and capture vibrations in a metal spring. The longer the spring, the longer the decay time of the reverberation.

Master FX Level Knob



The channel signals come through this FX knob and continue on to the main mix knob, the mix 1 and mix 2 knobs, and the headphones knob. They contain the effects' "wet" signals and are mixed together with the channels' "dry" original signals. The controls are off when fully turned down and can provide up to 10 dB of gain turned fully up (MAX).

Note that there is a line that seemingly connects the FX Select Switch (see above) and the FX Level Knob (to the left). Coincidence? We think not... they are there to show you that they are connected. The FX Select Switch is where to choose an effect and the Master FX Level Knob is where to set the master effects level. Don't forget to raise (or lower) the FX knob on the input channels requiring effects!

Phones Knob



This knob is used to adjust the volume at the phones output from ∞ (off) to maximum gain (max). Make sure that this knob is fully off [counter-clockwise] before selecting or adding a new source.



WARNING: The headphone amp is loud and can cause permanent hearing damage. Even intermediate levels may be painfully loud with some headphones. **BE CAREFUL!** Always turn the phones level control all the way down before connecting headphones or pressing a solo switch, or doing anything new that may affect the headphone volume. Then turn it up slowly as you listen carefully.

Main Mix Level Knob



This knob allows you to adjust the levels of the main mix signals sent to the 1/4" main line-level outputs.

This gives you the ultimate feeling of power and control over the sound levels sent to your audience. Adjust this control carefully, with your good eye on the meters to check against overloading, and your good ear to the levels to make sure your audience (if any) is happy.

The main mix signals are off with the knob fully down, the "U" marking is unity gain, and fully up provides 10 dB of additional gain. This additional gain will typically never be needed, but once again, it's nice to know that it's there. This is the ideal control to slowly bring down at the end of a song (or quickly in the middle of a song if the need ever arises).

Main Meters

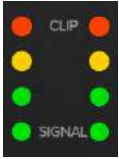

These peak meters are made up of two columns of four LEDs, with three colors to indicate different ranges of signal level, traffic light style. Most amplifiers clip at about +10 dBu, and some recorders aren't so forgiving either. For best real-world results, try to keep your peaks in the green with the occasional yellow bump. Remember, audio meters are just tools to help assure you that your levels are "in the ballpark." You don't have to stare at them (unless you want to).

Level indicators:

Color	Level
Red	Clip
Amber	+10 dBu
Green	0 dBu
Green	-10 dBu

Battery Operation

MobileMix will function via portable battery (power bank) without the need to be plugged into a live AC outlet. This is great for mobile gigging, live streaming, and more!



SAFETY FIRST: Before installing and using this product, please read these instructions carefully. Failure to follow the precautions may result in damage, injury, or even death.

- 1. WARNING:** The battery (battery or batteries or battery pack) shall not be exposed to excessive heat such as sunshine, fire or the like.
- 2. CAUTION:** Danger of explosion if battery is incorrectly connected.
- 3.** No open flame sources, such as lighted candles, should be placed on the apparatus.

WARNING: When installing this product, always respect the safety standard. Do not install the product in any way that is not described in these instructions.

BATTERY / COVER REMOVAL INSTRUCTIONS:

Unplug MobileMix and set it down with the knobs facing down on a soft, flat surface.

Using your thumbs, push the two locking tabs towards the rear panel first (as seen below), then up towards the sky once released. The battery compartment cover can then lie flat on its back while you continue work on the battery compartment.

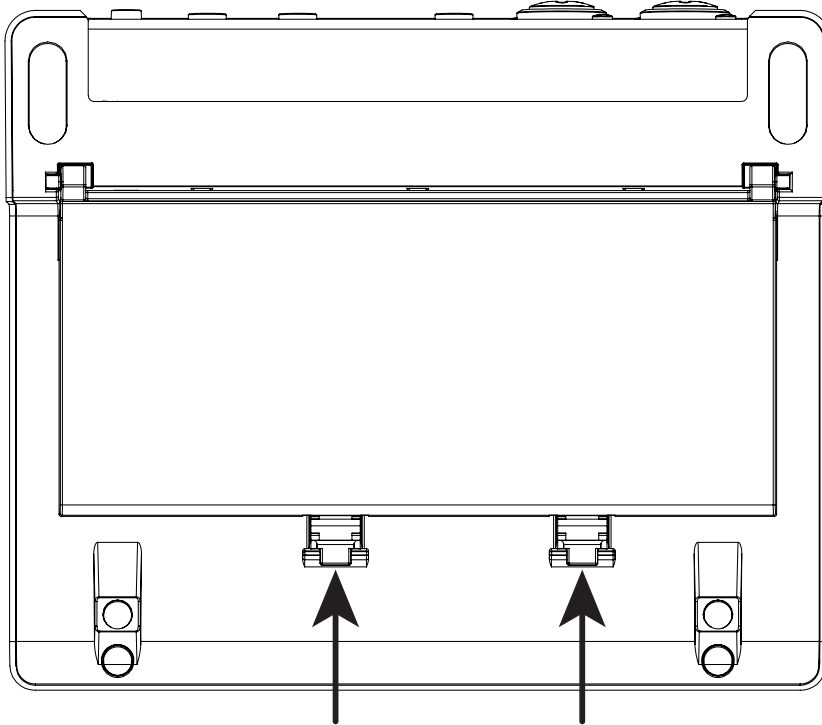

As seen below, a removable battery may fit anywhere within the dotted line.

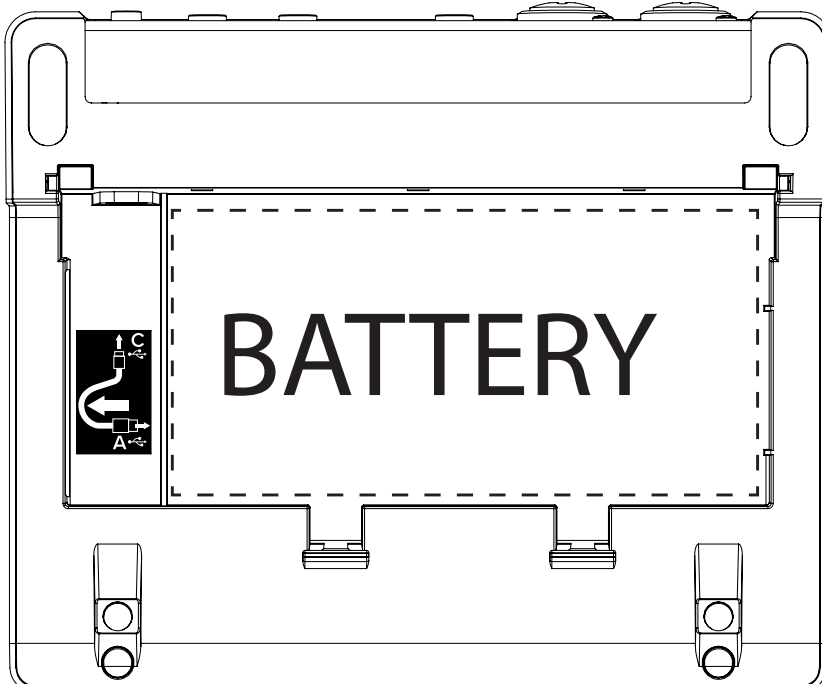

BATTERY INSTALLATION INSTRUCTIONS:

1. As seen in the drawing above, a short USB-C to USB-A cable needs to be attached to the mixer. This cable is included in the packaging. Plug the USB-C side to the mixer as seen in the drawing below.

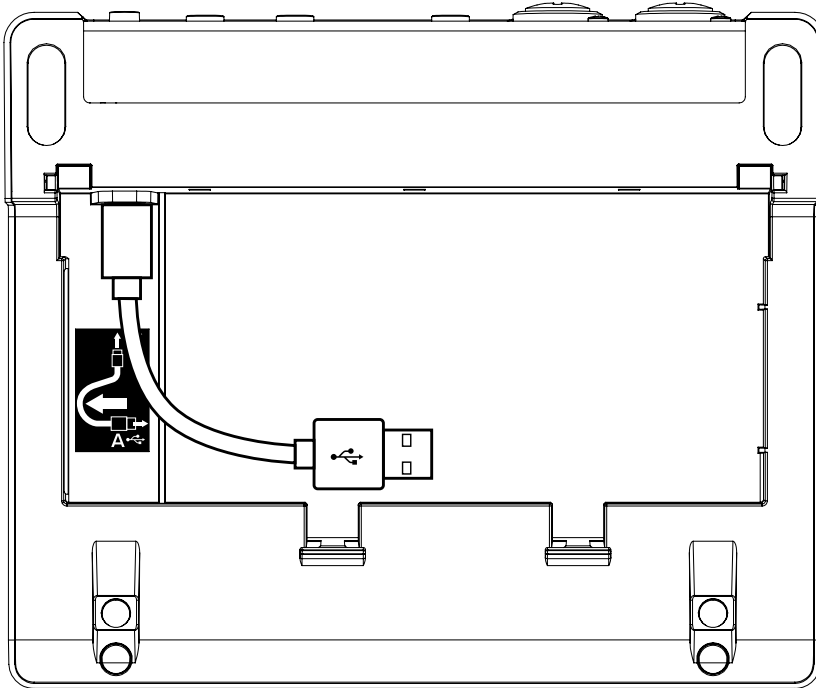

2. Plug the USB-A side to a CHARGED portable battery (power bank). Hey, a dead battery won't do you any good!

3. **Optional** – MobileMix arrives with some rubber strips inside of the battery compartment. These may be utilized to keep the battery snug and tight, with minimal (or even no) movement.

4. Replace the battery cover pushing down on it until it locks into place. Do not force it!



When not in use, a spare battery (purchased separately) may be charged by plugging the included wall adapter into the power receptacle of the battery and the other side into a live AC outlet. The battery will also charge while inside a plugged-in MobileMix.

These are the most important battery specs to look for:

- 5V === 1.2A
- **Size:** no larger than 5.5 in / 140 mm x 2.75 in / 70 mm.

Angled Phone / Tablet Slot

Conveniently located on MobileMix is a slot to hold a phone or tablet. It is angled perfectly for most livestreaming applications, reducing the need for a tripod or – let's be realistic – a few books to prop up the device.

Hookup Diagrams

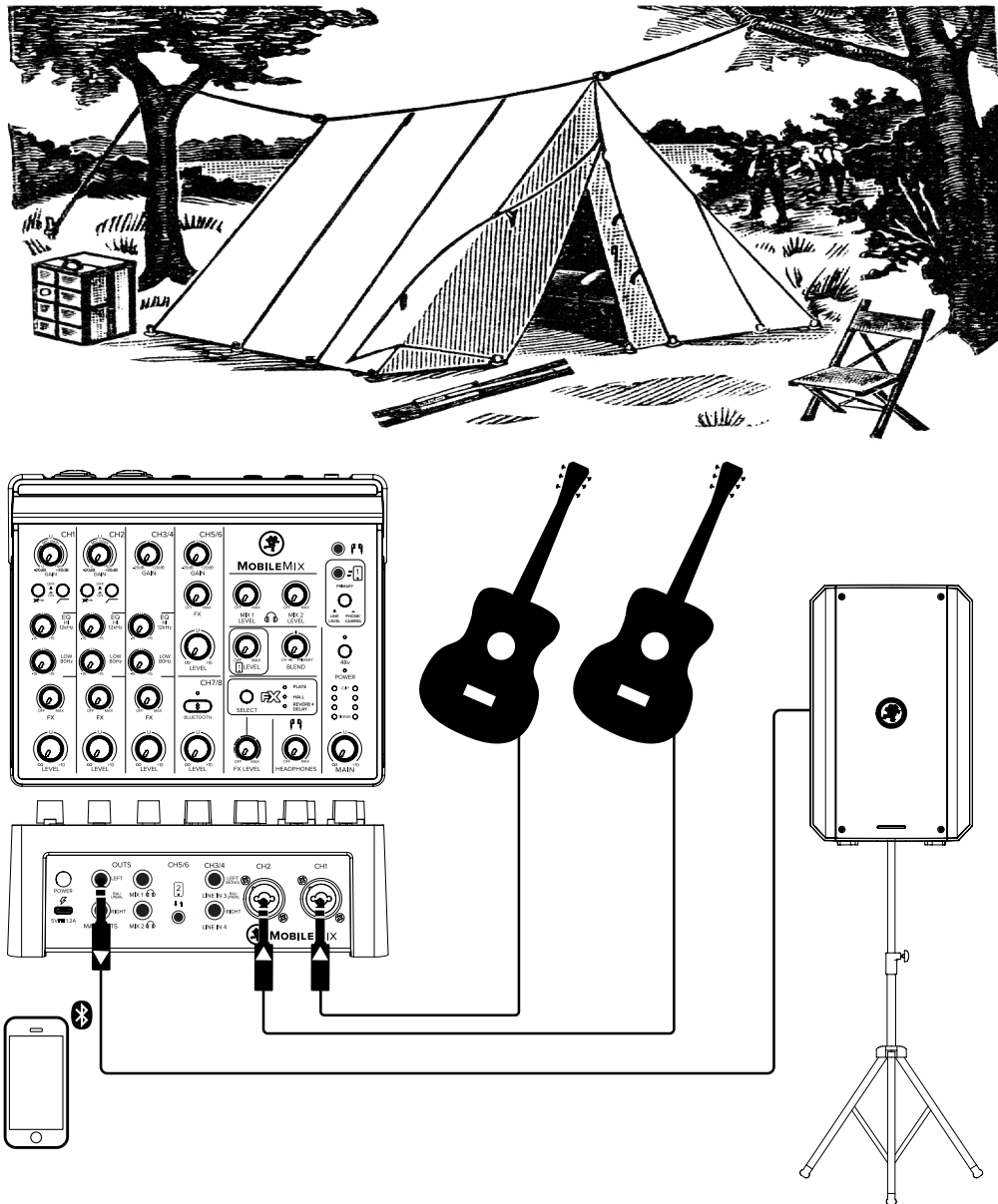

Hookup Diagrams > Camping

A family loves to go camping... but they also love to play music together. With Mackie MobileMix, both are a possibility!

After pitching a tent and grabbing firewood – but before snipe hunting – we would like to get everything connected. Here we have two guitars plugged into the channel 1 and channel 2 inputs. The Hi-Z switch should be engaged on both channels. A phone is connected via Bluetooth to play backing tracks, beats, or whatever else you decide!

The main left output is connected to the input of a Thump GO – which may also be powered via battery – so the glorious tunes may be enjoyed by all around the campfire.

When you're finished playing guitar, remove them from the inputs and replace them with two mics (making sure the Hi-Z switch is disengaged). The phone plays whatever songs are chosen and people can take turns singing along to their favorite songs. We call this campaoke. And it's super-fun!

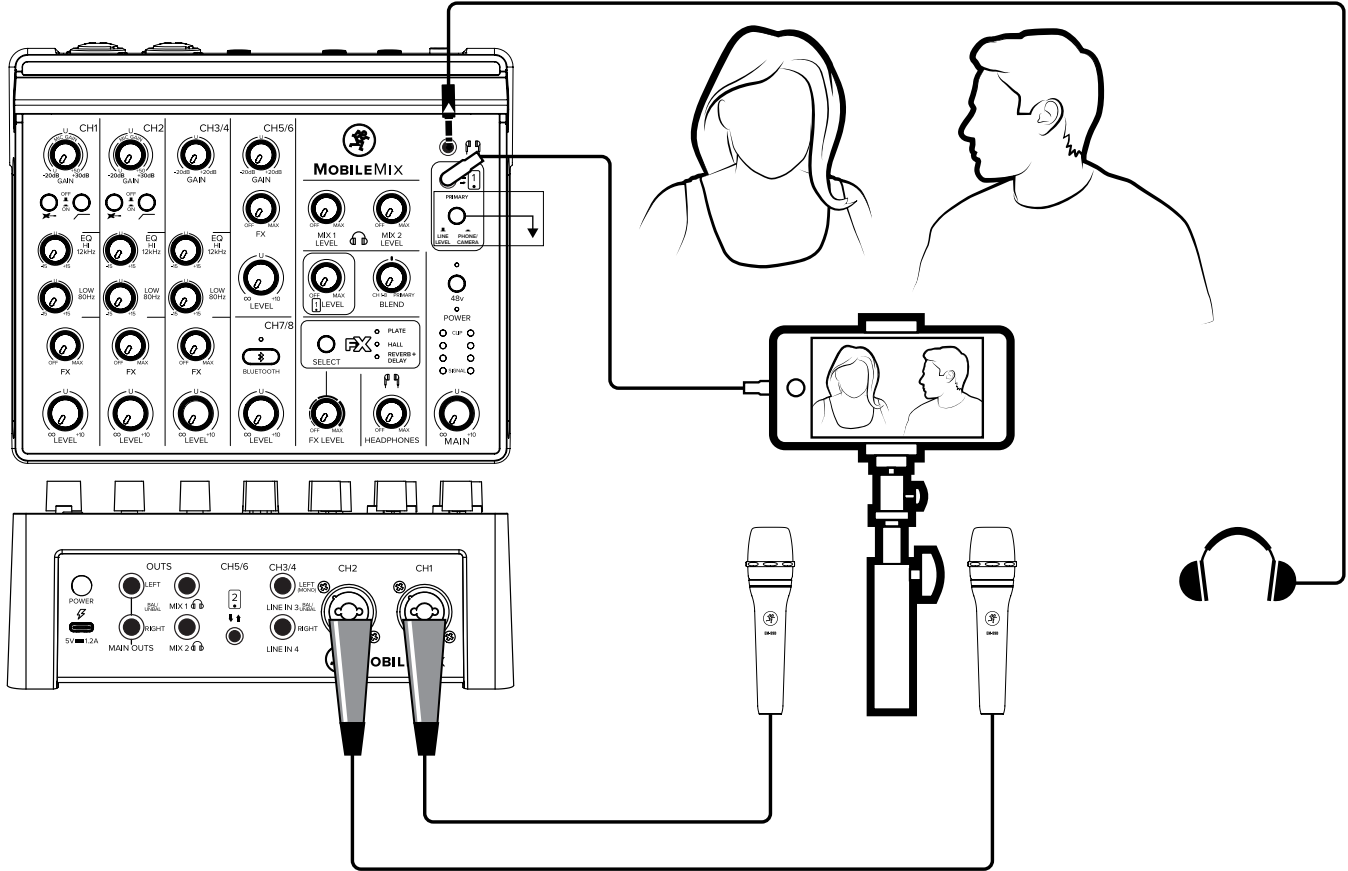

Hookup Diagrams > Live Streaming

A popular use of MobileMix is for live streaming (and/or podcasting). This is an easy setup starting with two microphones connected to the channel 1 and channel 2 inputs. This is for the two people involved in the live streaming broadcast.

The videographer holds his phone – connected to the primary phone/camera jack (switch down) – steady on the two and uses a set of headphones for listening and level checks.

Because MobileMix may be powered up via electrical outlet or battery, almost the entire world is your oyster! Go ahead and film a livestream out in a field, on a set of train tracks – make sure no trains are coming! – at a National Park, or any other area where electrical outlets are unavailable.

Appendix A : Service Information

Troubleshooting

If you think your Mackie product has a problem, please check out the following troubleshooting tips and do your best to confirm the problem. Visit the Support section of our website (www.mackie.com) to get some ideas or contact our technical support heroes. You may find the answer to the problem without having to send your Mackie product away.

Here are some useful tips that could correct any of the issues outlined below (or possibly any other issue that we haven't yet discovered):

Level setting procedure: If you are having any sound (or non-sound) issues, try following the level setting procedure as outlined on page 6 to verify that all of the volume controls in the system are properly adjusted.

There are no user serviceable parts. If none of these tips work, please refer to "Repair" on the next page to find out how to proceed.

No Power

- Our favorite question. Is it plugged in (whether by power cord or battery)?
- Our favorite follow-up question. If using a battery, is it fully charged? Are you sure?!
- Our second favorite question. Is the rear panel power switch in the ON position?
- Are all the lights out in town? If so, contact the local power company to get power restored.

No Sound

- Are all the connections good and sound? Make sure all of the connecting cables work and are securely connected at both ends. Try the same source signal in another channel, set up exactly like the suspect channel.
- Is the signal source powered on? Is it working (and making union scale)?

Noise / Hum

- Are you using unbalanced cables? Swap them out with balanced cables to see if that fixes the problem.
- Turn the input gains down one-by-one. If the offending noise disappears, it's either that input or whatever is plugged into it. If you unplug the whatever-is-plugged-into-it and turn the input gain back up and the noise is gone, it's from your whatever.
- Is phantom power required for the microphone?
- Sometimes it helps to plug all the audio equipment into the same AC circuit so they share a common ground. Make it so.

Other Issues

- Bluetooth Blues?
 - Restart the Bluetooth device. Completely power it down, then power it back up.
 - Restart MobileMix. A simple reboot can sometimes work great wonders.
 - Please email or call Technical Support if you are having any other issue not listed here:
 - o mackie.com/support-contact
 - o 1-800-898-3211

Repair

For warranty service, refer to the warranty information on page 30.

Non-warranty service for Mackie products is available at a factory-authorized service center. To locate the nearest service center, visit www.mackie.com, click “Support” and select “Service Center Locator”. Service for Mackie products living outside the United States can be obtained through local dealers or distributors.

If you do not have access to our website, you can call our Tech Support department at 1-800-898-3211, Monday-Friday during normal business hours, Pacific Time, to explain the problem. Tech Support will tell you where the nearest factory-authorized service center is located in your area.

Appendix B : Technical Information

Specifications

Noise Characteristics

Equivalent Input Noise (EIN) (150 Ω Source Impedance, 20 Hz to 20 kHz)

Mic in to main out, max gain:-125 dBu

Residual Output Noise

All outputs, master levels and channel levels off: -97 dBu

All outputs, master levels unity, one channel level unity:..... -87 dBu

Frequency Response

Mic input to any output (gain at unity, +0 dB / -1 dB):..... 20 Hz to 30 kHz

Distortion (THD+N)

(22 Hz to 80 kHz bandwidth)

Mic in to Main Out (+4 dBu output):..... <0.01%

Attenuation and Crosstalk

Adjacent Inputs @1 kHz:-90 dB

Inputs to Outputs @1 kHz:-80 dB

Fader Off @1 kHz: -85 dB

Common Mode Rejection Ratio (CMRR)

Mic in to Main out, max gain, 1 kHz:..... 80 dB

Maximum Levels

All inputs:+10 dBu
Main Mix XLR:.....+10 dBu
All other outputs:+10 dBu

Impedances

Mic in: 3.3 k Ω
All other inputs: \geq 20 k Ω
Phones out / Mix out:..... 25 Ω
All other outputs:120 Ω Unbalanced,
240 Ω Balanced

Equalization

Low: \pm 15 dB @ 80 Hz
High: \pm 15 dB @ 12 kHz
Low Cut Filter:..... 18 dB/octave @ 100 Hz

Digital Effects

FX Presets:Plate, Hall, Reverb + Delay

Phantom Power

48 VDC to channels 1 and 2

Power Requirements

Power Connector 100VAC-240VAC, 50-60 Hz
5.0V \equiv 1.2A

Operating Temperature:.....0-45 $^{\circ}$ C // 32-113 $^{\circ}$ F

Bluetooth

Bluetooth: 5.1

Dimensions

Size (H x W x D): 3.0 x 7.9 x 6.9 in // 75 x 201 x 175 mm

Weight: 1.8 lb // 0.8 kg

About

Part Number, Rev and Date: SW1432, Rev A, November 2023

MobileMix Dimensions

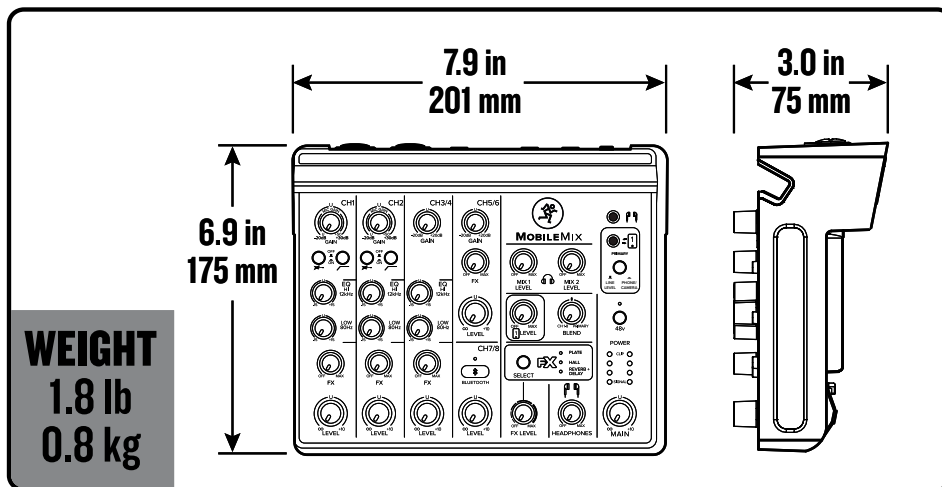

LOUD Audio, LLC. is always striving to improve our products by incorporating new and improved materials, components, and manufacturing methods. Therefore, we reserve the right to change these specifications at any time without notice. The "Running Man" is a registered trademark of LOUD Audio, LLC. All other brand names mentioned are trademarks or registered trademarks of their respective holders, and are hereby acknowledged.

Please check our website for any updates to this Owner's Manual: www.mackie.com.
©2023 LOUD Audio, LLC. All right All right All rights reserved.

MobileMix Block Diagram

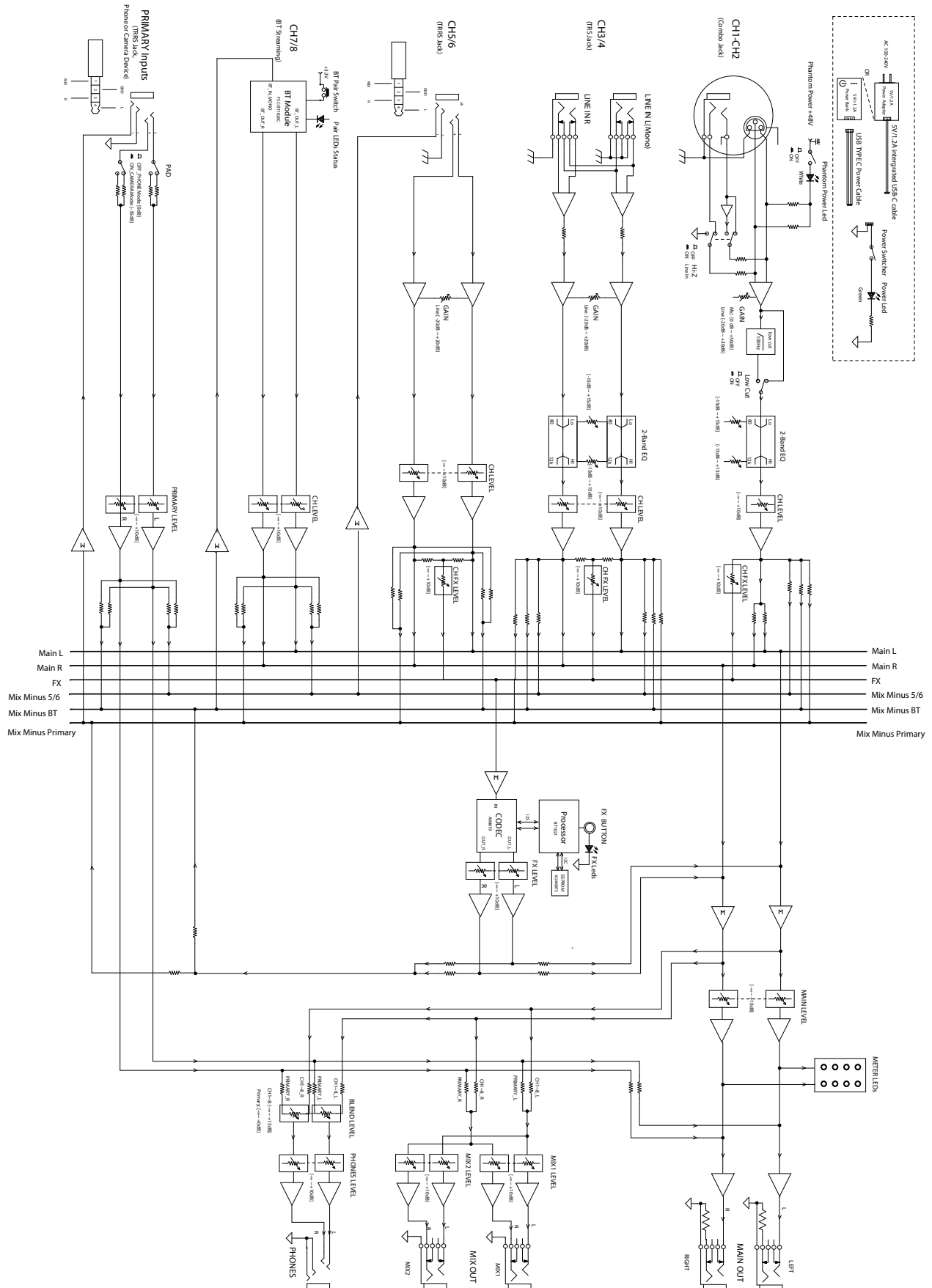

Warranty Statement

Please keep your sales receipt in a safe place.

This Limited Product Warranty ("Product Warranty") is provided by LOUD Audio, LLC. ("LOUD") and is applicable to products purchased in the United States or Canada through a LOUD-authorized reseller or dealer. The Product Warranty will not extend to anyone other than the original purchaser of the product (hereinafter, "Customer," "you" or "your").

For products purchased outside the U.S. or Canada, please visit www.mackie.com/warranty to find contact information for your local distributor, and information on any warranty coverage provided by the distributor in your local market.

LOUD warrants to Customer that the product will be free from defects in materials and workmanship under normal use during the Warranty Period. If the product fails to conform to the warranty then LOUD or its authorized service representative will at its option, either repair or replace any such nonconforming product, provided that Customer gives notice of the noncompliance within the Warranty Period to the Company at: www.mackie.com/support or by calling LOUD technical support at 1.800.898.3211 (toll-free in the U.S. and Canada) during normal business hours Pacific Time, excluding weekends or LOUD holidays. Please retain the original dated sales receipt as evidence of the date of purchase. You will need it to obtain any warranty service.

For full terms and conditions, as well as the specific duration of the Warranty for this product, please visit www.mackie.com/warranty.

The Product Warranty, together with your invoice or receipt, and the terms and conditions located at www.mackie.com/warranty constitutes the entire agreement, and supersedes any and all prior agreements between LOUD and Customer related to the subject matter hereof. No amendment, modification or waiver of any of the provisions of this Product Warranty will be valid unless set forth in a written instrument signed by the party to be bound thereby.

Need help with MobileMix?

- Visit www.mackie.com/support to find: FAQs, manuals, addendums, and other documents.
- Email us at: www.mackie.com/support-contact
- Telephone 1-800-898-3211 to speak with one of our splendid technical support chaps (Monday through Friday, normal business hours, Pacific Time).

Please write the serial numbers here for future reference (i.e., insurance claims, tech support, return authorization, make dad proud, etc.)

Purchased at:

Date of purchase:



19820 North Creek Parkway #201, Bothell, WA 98011 • USA
Phone: 425.487.4333 • Toll-free: 800.898.3211
Fax: 425.487.4337 • www.mackie.com

