



USER MANUAL

Klipsch[®]

C-SERIES

APP CONTROLLED SUBWOOFERS

CONTENTS

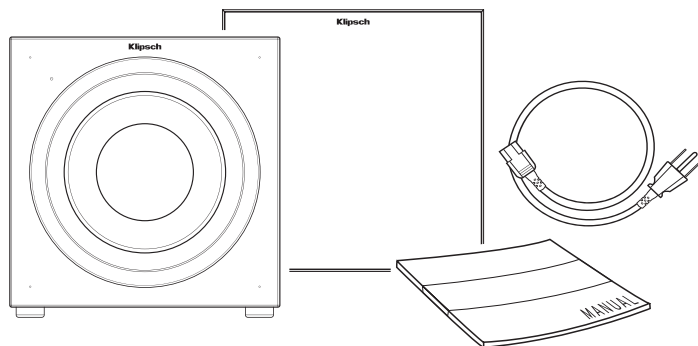

CARE AND CLEANING

Your subwoofer has a finish that should only require dry dusting or cleaning with a dry cloth. Avoid the use of abrasive or solvent-based cleaners and harsh detergents.

LOW CONTROL APP

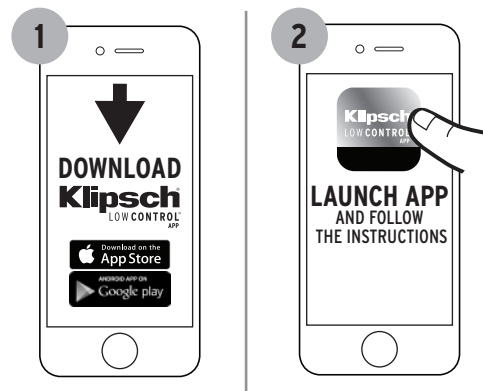

PRODUCT REGISTRATION

Register your product online at www.klipsch.com/register

- Keep up-to-date on new products and promotions.
- Your personal information will never be resold.
- This registration information is not used for warranty purposes.

Please retain your receipt for warranty claims.

CONNECTIONS

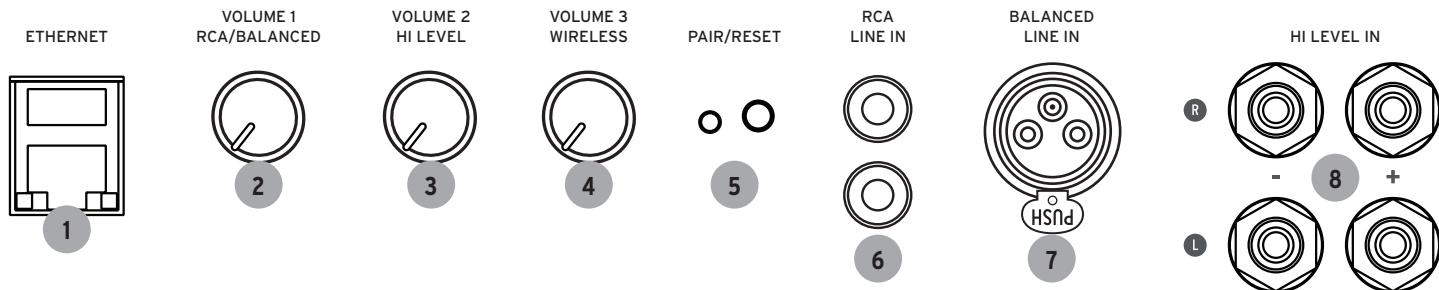

1 - Ethernet Input for IP Control	2 - Line Level Volume Control Controls Volume RCA and XLR input	3 - Hi-Level Volume Control Controls Volume of High Level Input	4 - Wireless Volume Control Controls Volume of Wireless Input*
5 - PAIR / RESET Button For Pairing to WA-3 Wireless Transmitter*	6 - RCA Unbalanced Line Input	7 - XLR Balanced Line Input	8 - Hi-Level (Speaker Level) Input

*See WA-3 Kit manual for more information

FRONT LED

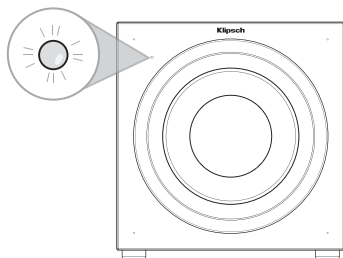

WHITE	On
BLUE	On, App Connected
ORANGE	Firmware Updating
OFF	Standby

POSITIONING YOUR SUBWOOFER

Klipsch® powered subwoofers are designed to reproduce deep bass and deliver the impact that makes your movies and music come alive. Typically, optimum performance will result if you place your subwoofer in a corner of the room on the same wall as your front channel speakers (Refer to Figure 1). Please note that room placement can have a dramatic effect upon the performance of your powered subwoofer. Corner placement, as suggested above, will increase the amount of bass output, while placing the subwoofer along the middle of a wall, or out in the room will decrease the amount of bass output. Experiment with a number of different placement options and control settings to find the one that best suits your particular room and taste. When choosing your subwoofer's location, keep in mind that you will need to connect the subwoofer's built-in amplifier to an AC power outlet.

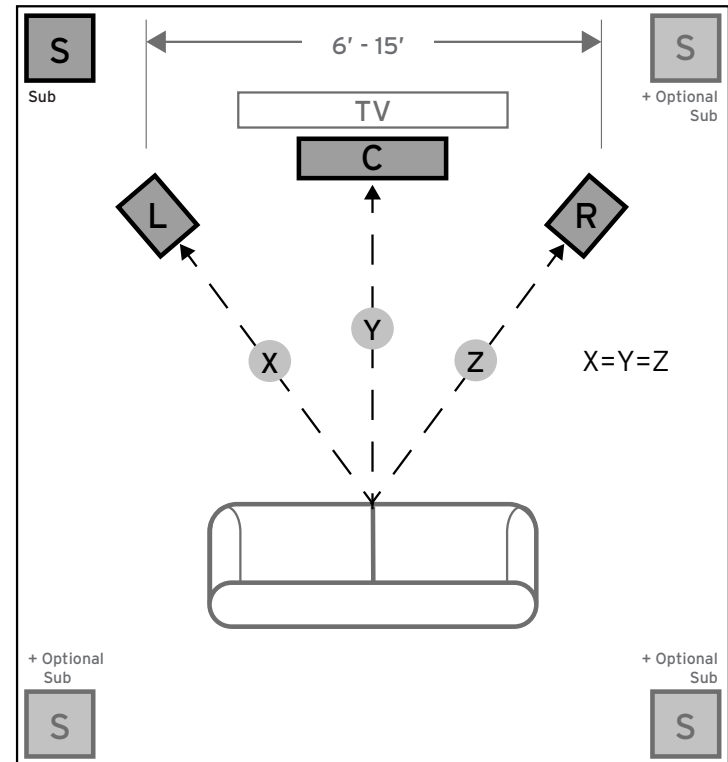
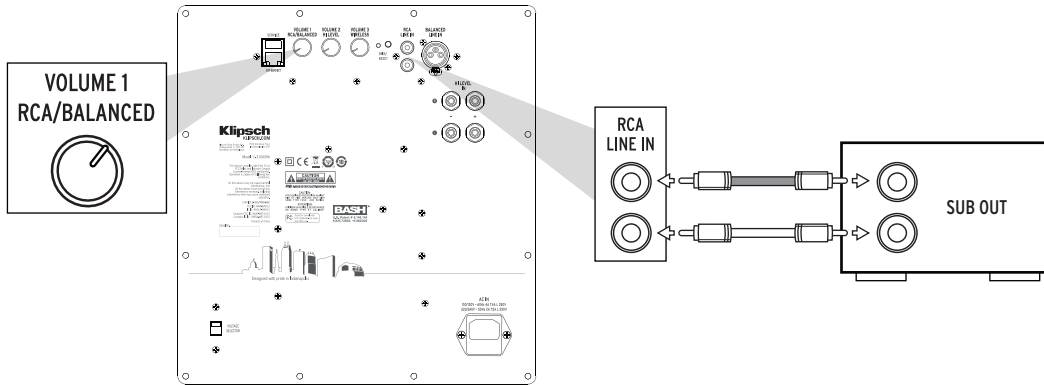
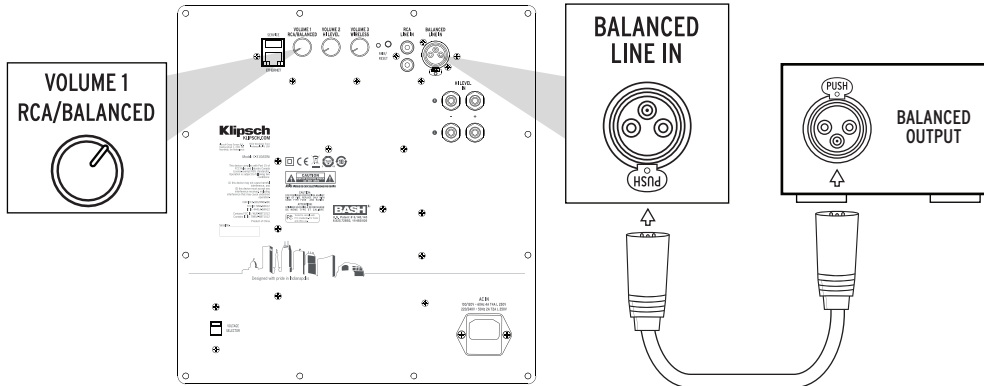

FIGURE 1
SPEAKER PLACEMENT IN LISTENING AREA

UNBALANCED INPUT



BALANCED INPUT



HIGH LEVEL INPUT

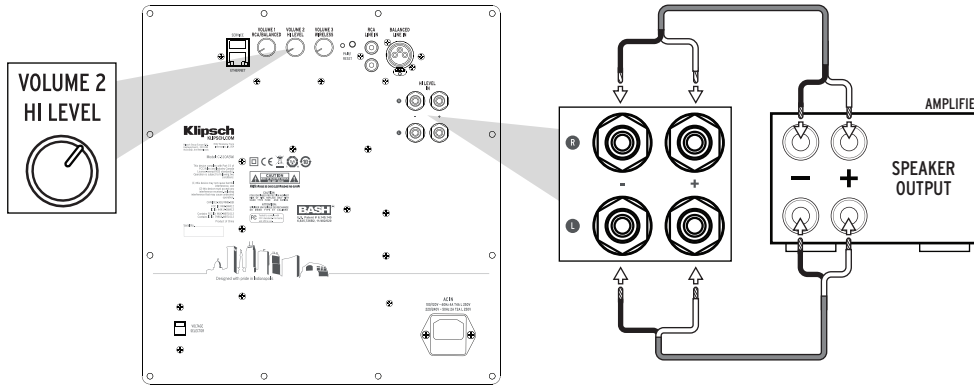

WIRELESS INPUT *SEE WA-3 KIT MANUAL FOR MORE INFORMATION

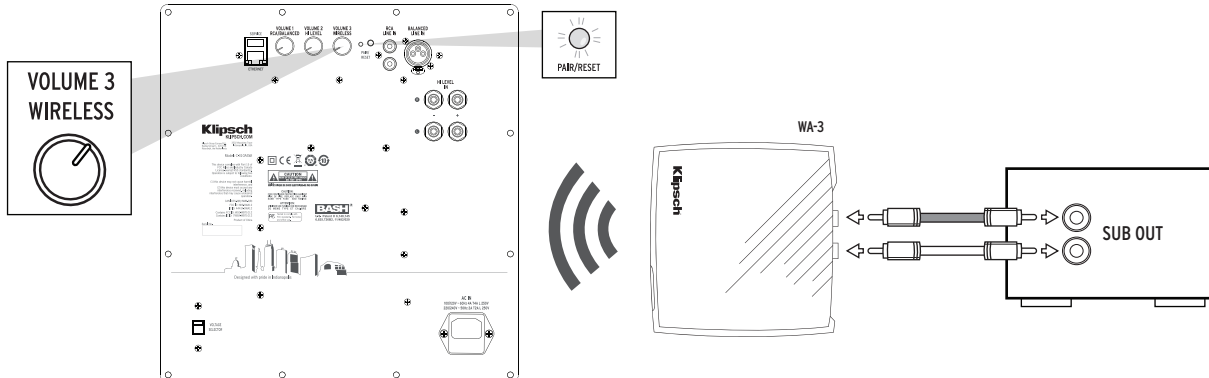

AUTOMATIC ROOM CORRECT

1. Launch the Klipsch Low Control App
2. Press “AUTO EQ”
3. Follow the instructions



IP CONTROL / INPUT

Control drivers are available at klipsch.com/cseries

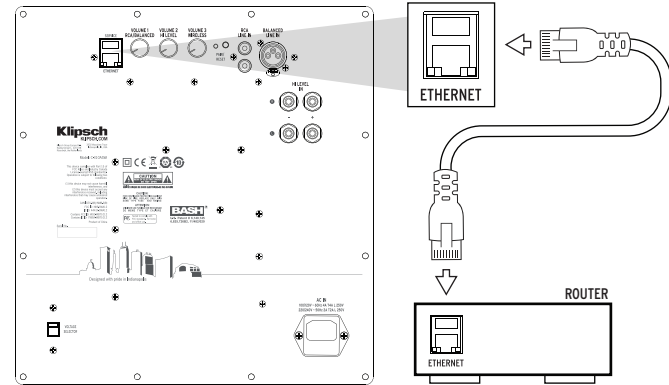

*Subwoofer Defaults to DHCP

TABLE DES MATIÈRES

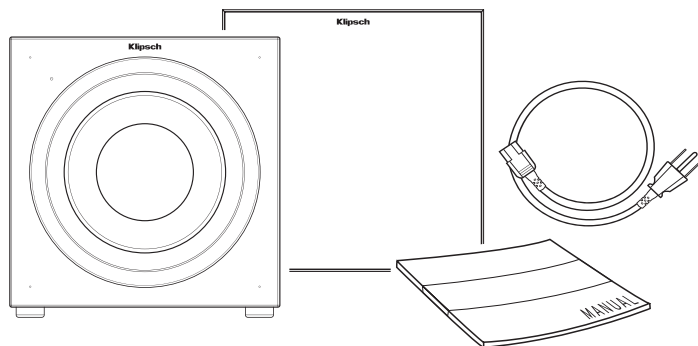

ENTRETIEN ET NETTOYAGE

Votre caisson de graves a une finition qui ne devrait nécessiter qu'un dépoussiérage ou un nettoyage avec un chiffon sec. Évitez d'utiliser des nettoyeurs abrasifs ou à base de solvants ainsi que des détergents agressifs.

LOW CONTROL APP

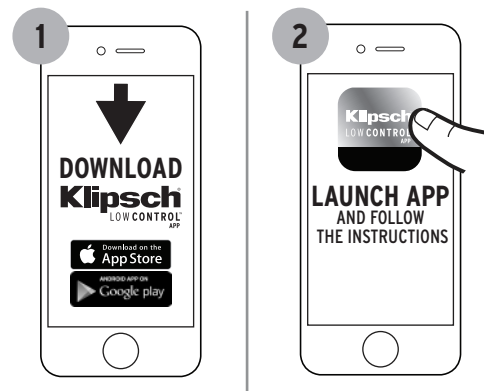

ENREGISTREMENT DU PRODUIT

Enregistrez votre produit en ligne sur www.klipsch.com/register

- Restez au courant des nouveaux produits et promotions.
- Vos informations personnelles ne seront jamais revendues.
- Ces informations d'enregistrement ne sont pas utilisées à des fins de garantie.

Veillez conserver votre reçu pour les réclamations de garantie.

CONNECTIONS

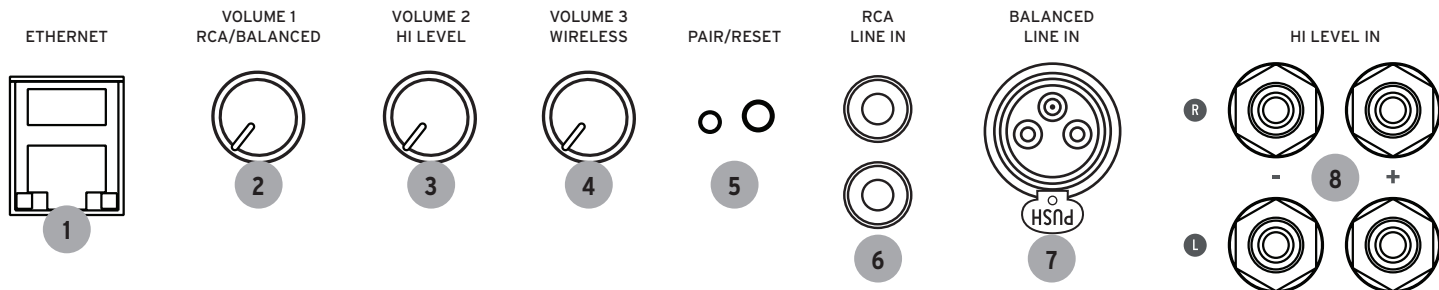

1 - Entrée Ethernet pour le contrôle IP	2 - Contrôle du volume au niveau ligne Contrôle le volume des entrées RCA et XLR	3 - Contrôle du volume à haut niveau Contrôle le volume de l'entrée à haut niveau	4 - Contrôle du volume sans fil Contrôle le volume de l'entrée sans fil*
5 - Bouton Appariement/Réinitialisation pour appariement à l'émetteur sans fil WA-3*	6 - Entrée ligne asymétrique RCA	7 - Entrée ligne symétrique XLR	8 - Entrée à haut niveau (niveau haut-parleur)

*Consultez le manuel du kit WA-3 pour plus d'informations

LED AVANT

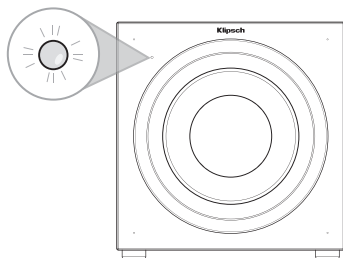

BLANC	Marche
BLEU	Allumée, App connectée
ORANGE	Mise à jour du micrologiciel
ARRÊT	Standby

POSITIONNEMENT DE VOTRE CAISSON DES GRAVES

Les caissons de graves actifs Klipsch® sont conçus pour reproduire les fréquences graves profondes et produire l'impact qui donne vie à vos films et à votre musique. Typiquement, les meilleures performances seront obtenues si vous positionnez votre caisson des graves dans un coin de la pièce sur le même mur que vos enceintes avant (voir la Figure 1). Veuillez noter que le positionnement dans la pièce peut avoir un effet spectaculaire sur les performances de votre caisson des graves actif. Le positionnement en angle, comme suggéré ci-dessus, augmentera la quantité de sortie des basses tandis que le positionnement du caisson au milieu d'un mur ou dans la pièce diminuera la quantité de basses en sortie. Expérimentez avec un certain nombre d'options de positionnement et de réglages des contrôles pour trouver ceux qui conviennent le mieux à votre pièce et à vos goûts. Lorsque vous choisissez l'emplacement de votre caisson des graves, n'oubliez pas que vous devrez brancher l'amplificateur intégré du subwoofer à une prise secteur.

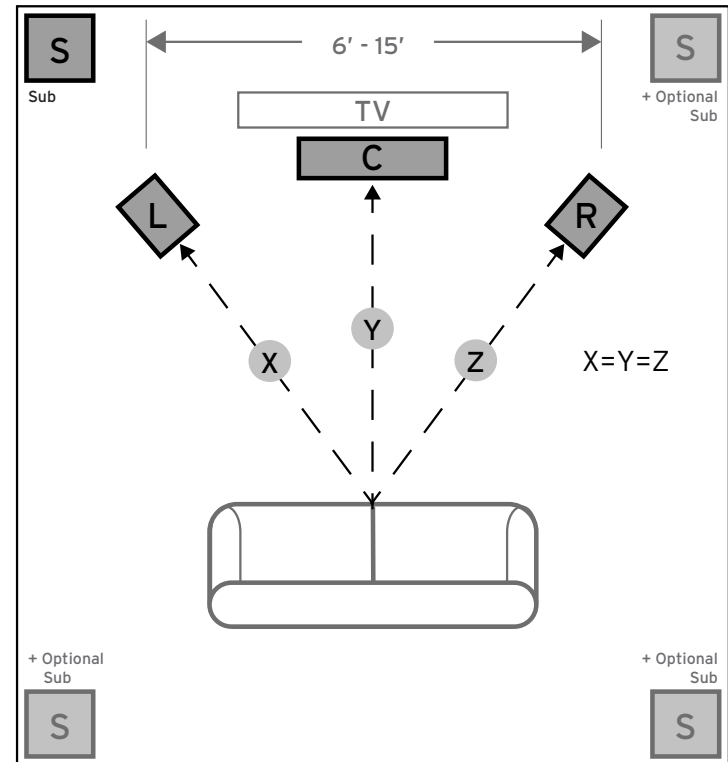
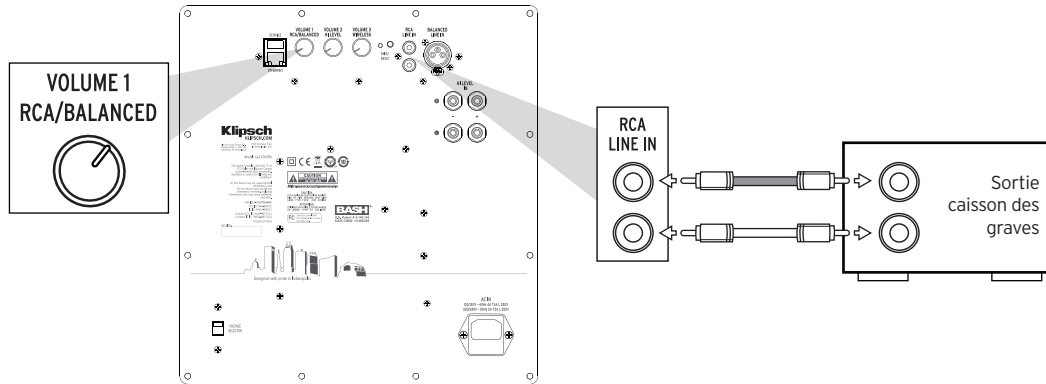
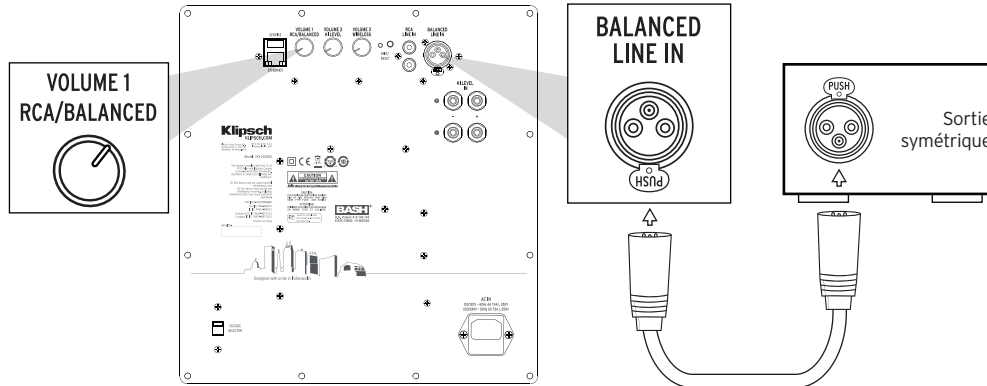

FIGURE 1
POSITIONNEMENT DU HAUT-PARLEUR DANS LA ZONE D'ÉCOUTE

ENTRÉE ASYMÉTRIQUE



ENTRÉE SYMÉTRIQUE



SORTIE SYMÉTRIQUE

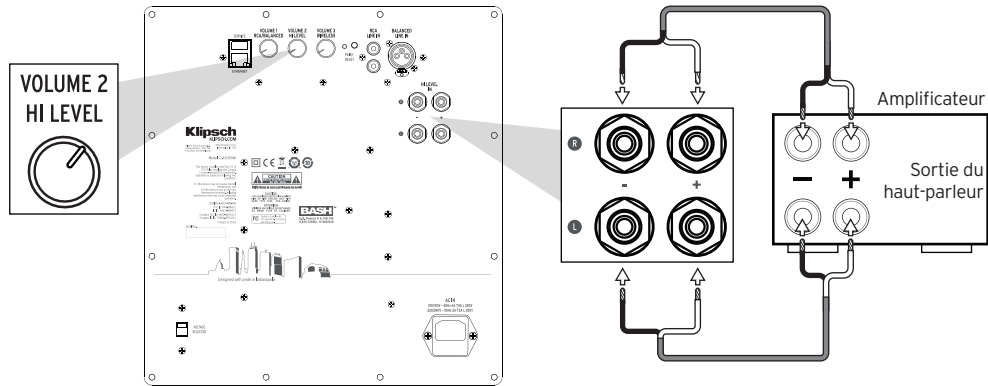

ENTRÉE SANS FIL *CONSULTEZ LE MANUEL DU KIT WA-3 POUR PLUS D'INFORMATIONS

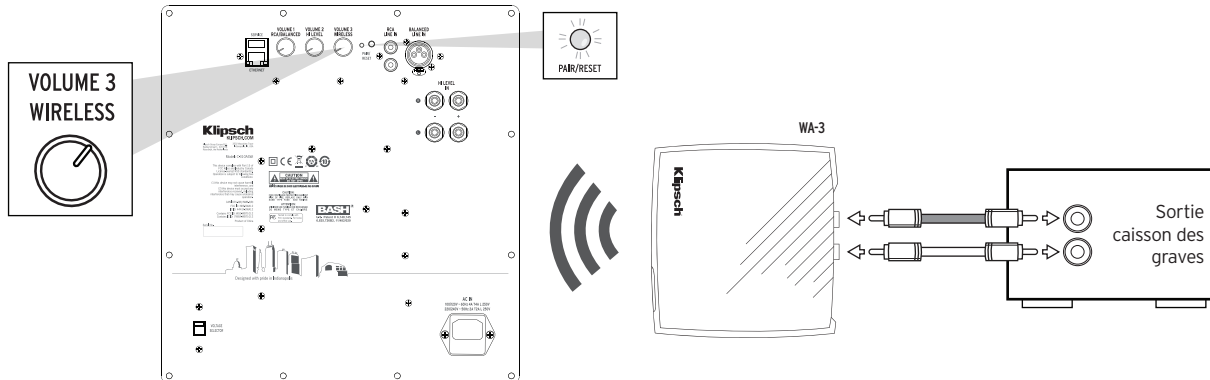

CORRECTION AUTOMATIQUE DE LA PIÈCE

1. lancez l'application Klipsch Low Control App
2. Appuyez sur « auto eq »
3. Suivez les instructions



CONTRÔLE IP/ENTRÉE IP

Les pilotes de contrôle (drivers) sont disponibles sur klipsch.com/cseries

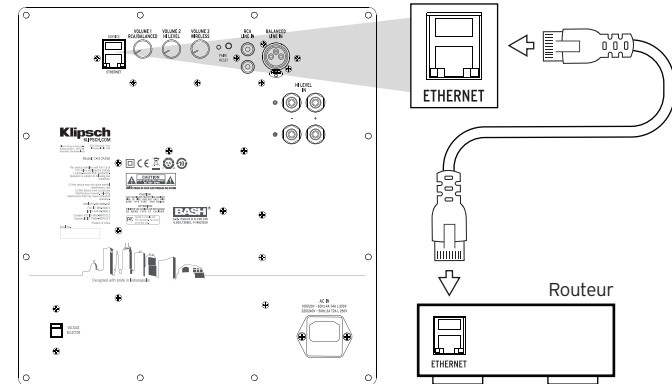

*Le caisson des graves passe par défaut sur DHCP

CONTENIDO

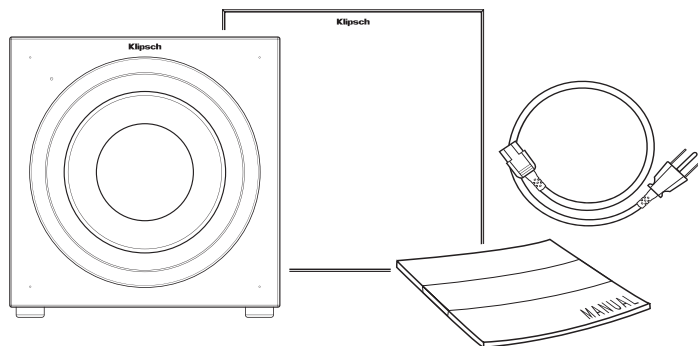

CUIDADO Y LIMPIEZA

El subwoofer tiene un acabado que debería requerir limpiarlo o quitarle el polvo solo con un paño seco. Evite los detergentes fuertes y los limpiadores abrasivos o a base de solvente.

LOW CONTROL APP

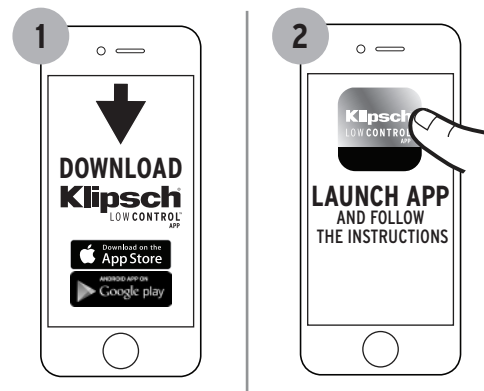

REGISTRO DEL PRODUCTO

Registre su producto en línea en www.klipsch.com/register

- Manténgase al día sobre nuevos productos y promociones.
- Sus datos personales nunca serán vendidos.
- Esta información de registro no se utiliza para propósitos de garantía.

Conserve su recibo para hacer reclamaciones de garantía.

CONEXIONES

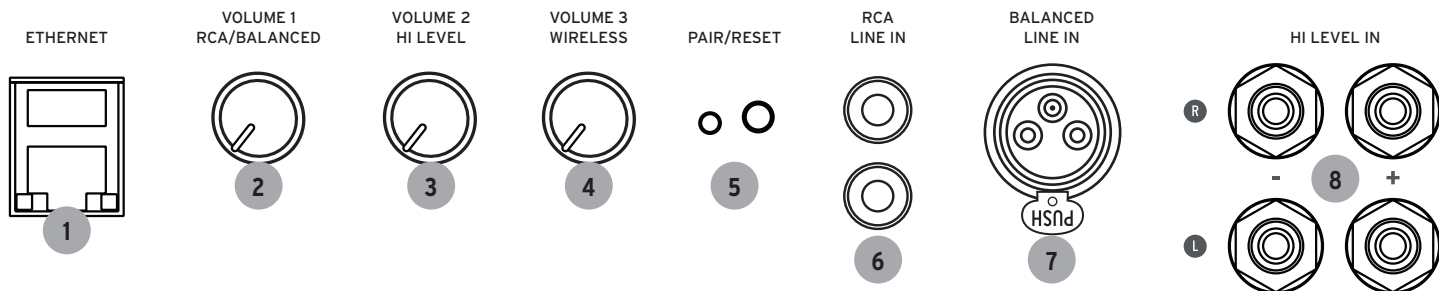

1 - Entrada Ethernet para control de IP	2 - El control de volumen de nivel de línea controla el volumen de la entrada RCA y la entrada XLR	3 - El control de volumen de alto nivel controla el volumen de la entrada de alto nivel	4 - El control de volumen inalámbrico controla el volumen de la entrada inalámbrica*
5 - Botón de vinculación y restablecimiento (PAIR / RESET) para vincular con el transmisor inalámbrico WA-3*	6 - Entrada de línea RCA no balanceada	7 - Entrada de línea XLR balanceada	8 - Entrada de alto nivel (nivel de altavoz)

* Consulte el manual del kit WA-3 para obtener más información

LED FRONTAL

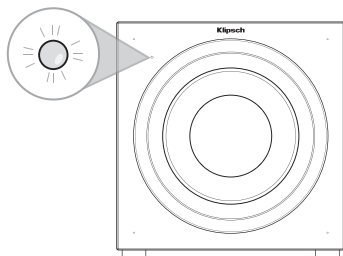

BLANCO	Activado
AZUL	Activado, aplicación conectada
ANARANJADO	Actualización de firmware
APAGADO	En Espera

UBICACIÓN DEL SUBWOOFER

Los subwoofers alimentados de Klipsch® han sido diseñados para reproducir bajos profundos y generar el impacto que hace que sus películas y su música cobren vida. Por lo general, el mejor rendimiento se logra cuando el subwoofer se coloca en una esquina de la sala junto a la pared contra la cual se ponen los altavoces de canal frontal (Consulte la figura 1). Tenga en cuenta que la ubicación en la sala puede tener un profundo efecto en el rendimiento del subwoofer alimentado. Poner el subwoofer en una esquina, como se sugiere, aumenta el rendimiento de bajos; ponerlo al centro de la pared o lejos de las paredes disminuye el rendimiento. Experimente con diversas opciones de colocación y configuraciones de controles hasta encontrar las que mejor se adapten a la sala y a su gusto en particular. Cuando escoja la ubicación del subwoofer, tenga en cuenta que es necesario conectar el amplificador integrado del subwoofer a un enchufe de corriente alterna.

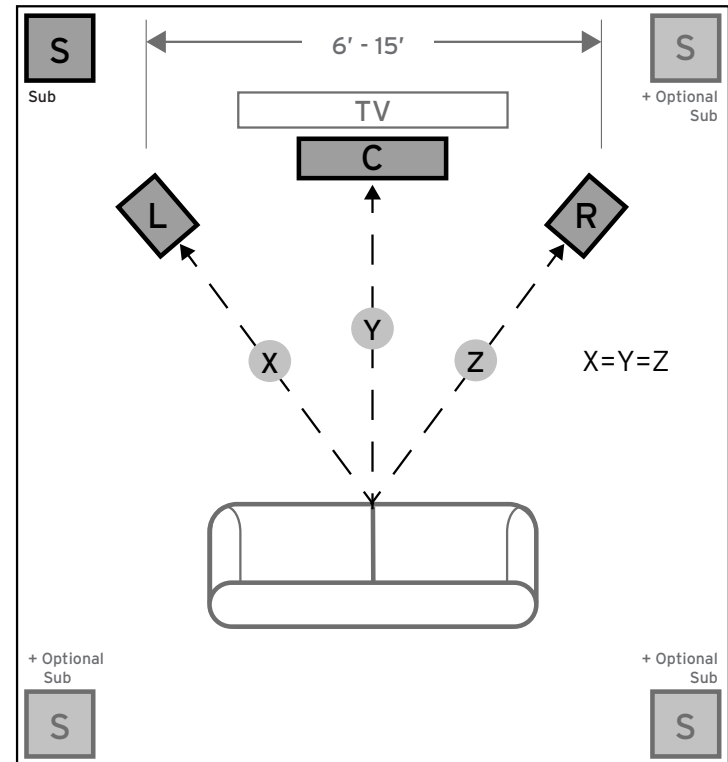
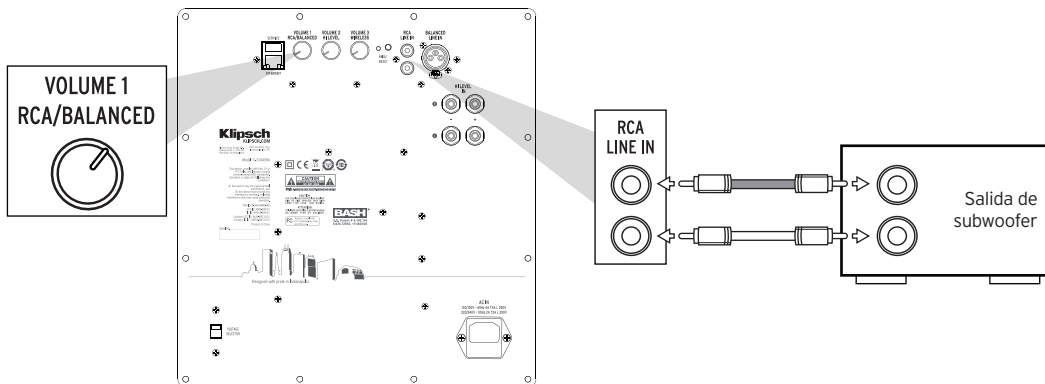
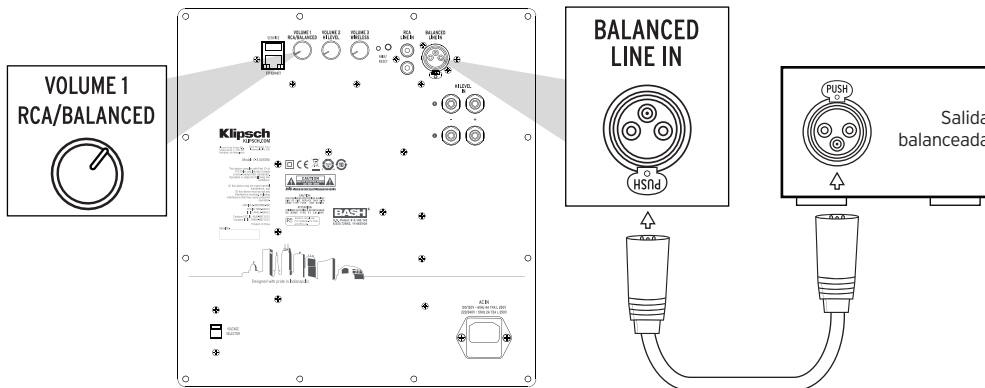

FIGURE 1
UBICACIÓN DEL ALTAVOZ EN EL ÁREA DE AUDICIÓN

ENTRADA NO BALANCEADA



ENTRADA BALANCEADA



CORRECCIÓN AUTOMÁTICA DE SALA

1. Inicie la aplicación LowControl App de Klipsch
2. Oprima "auto eq"
3. Siga las instrucciones



ENTRADA / CONTROL DE IP

Hay controladores de control en klipsch.com/cseries.

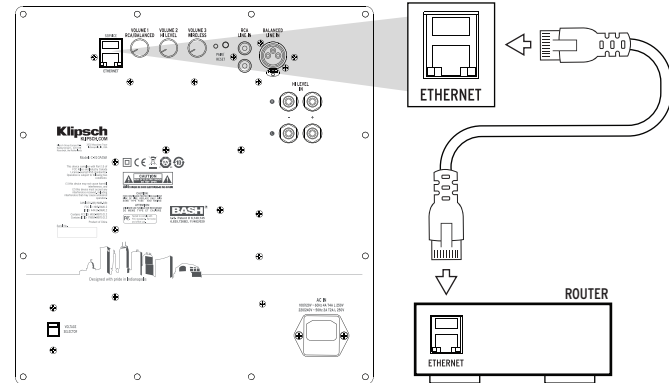

* Valores predeterminados de subwoofer para el DHCP

INHALT

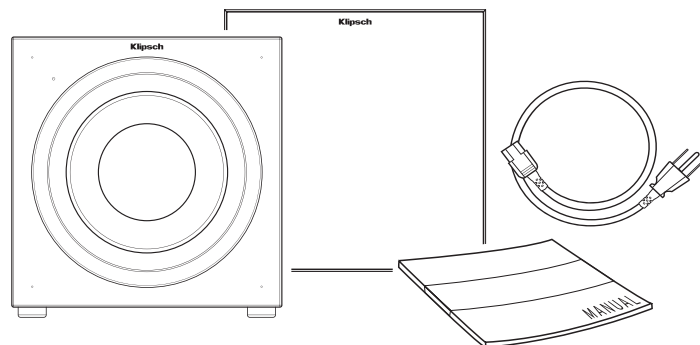

PFLEGE UND REINIGUNG

Ihr Subwoofer verfügt über eine Oberfläche, die nur mit einem trockenen Tuch abgestaubt oder gereinigt werden muss. Verwenden Sie keine Scheuer- oder Lösungsmittel oder scharfen Reinigungsmittel.

LOW CONTROL APP

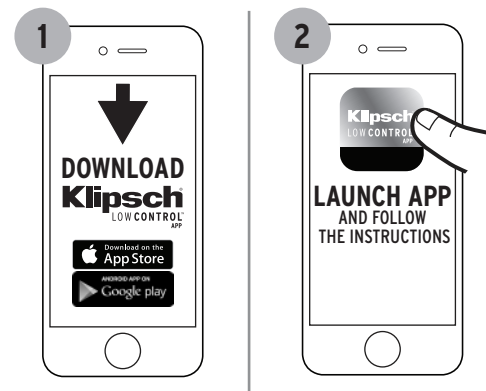

PRODUKTREGISTRIERUNG

Registrieren Sie Ihr Produkt online unter www.klipsch.com/register

- Dadurch werden Sie über neue Produkte und Sonderangebote informiert.
- Ihre personenbezogenen Daten werden nie verkauft.
- Diese Registrierungsdaten werden nicht zu Garantiezwecken verwendet.

Bewahren Sie bitte Ihre Quittung auf, um die Garantie in Anspruch nehmen zu können.

ANSCHLÜSSE

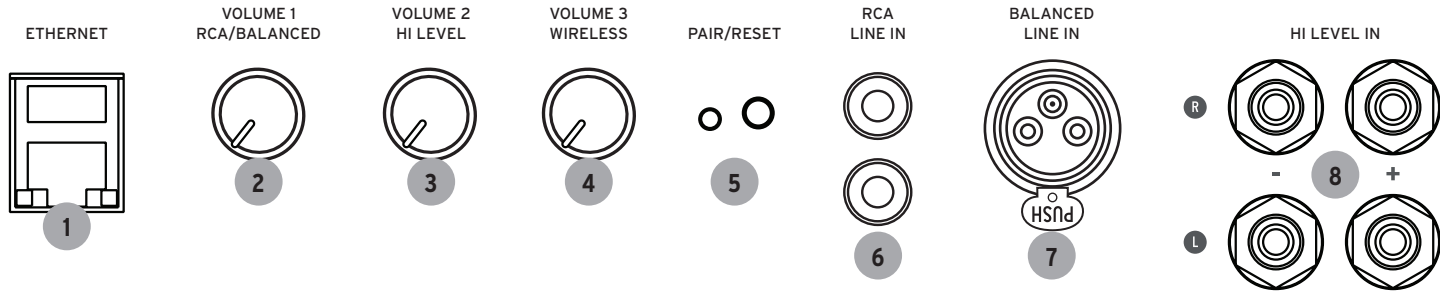

1 - Etherneteingang für IP-Kontrolle	2 - Line-Level-Regler kontrolliert Lautstärke für RCA- und XLR-Eingang	3 - Hi-Level-Regler kontrolliert Lautstärke für Hochpegeleingang	4 - Wireless-Regler kontrolliert Lautstärke für drahtlosen Eingang*
5 - PAIR / RESET-Taste für Kopplung mit WA-3 drahtlosem Sender*	6 - RCA Unsymmetrischer Line-Eingang	7 - XLR Symmetrischer Line-Eingang	8 - Hi-Level (Lautsprecherpegel) Eingang

*Weitere Informationen finden Sie in der Dokumentation des WA-3 Kit

VORDERE LED

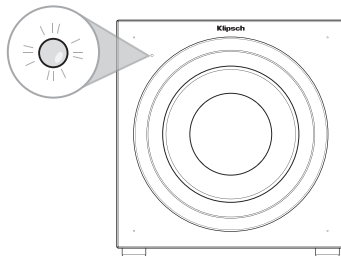

WEISS	Ein
BLAU	Ein, App verbunden
ORANGE	Firmware Updating
AUS	Standby

PLATZIERUNG DES SUBWOOFERS

Die Aktiv-Subwoofer von Klipsch® bieten tiefen Bass und einen Klang, der Ihre Filme und Ihre Musik zum Leben erweckt. Eine Platzierung des Subwoofers in einer Zimmerecke an der gleichen Wand wie die vorderen Lautsprecher (siehe Abbildung 1) bringt meistens die besten Ergebnisse. Denken Sie daran, dass die Platzierung im Raum einen enormen Effekt auf die Leistung Ihres Aktiv-Subwoofers haben kann. Die oben empfohlene Platzierung in einer Ecke steigert die Bassleistung, während eine Platzierung an der Mitte einer Wand oder von den Wänden entfernt die Bassleistung verringert. Experimentieren Sie mit verschiedenen Platzierungen und Geräteeinstellungen, um die ideale Kombination für Ihren Raum und Ihren Geschmack zu finden. Wenn Sie die Position Ihres Subwoofers wählen, sollten Sie daran denken, dass Sie den eingebauten Verstärker des Subwoofers ans Stromnetz anschließen müssen.

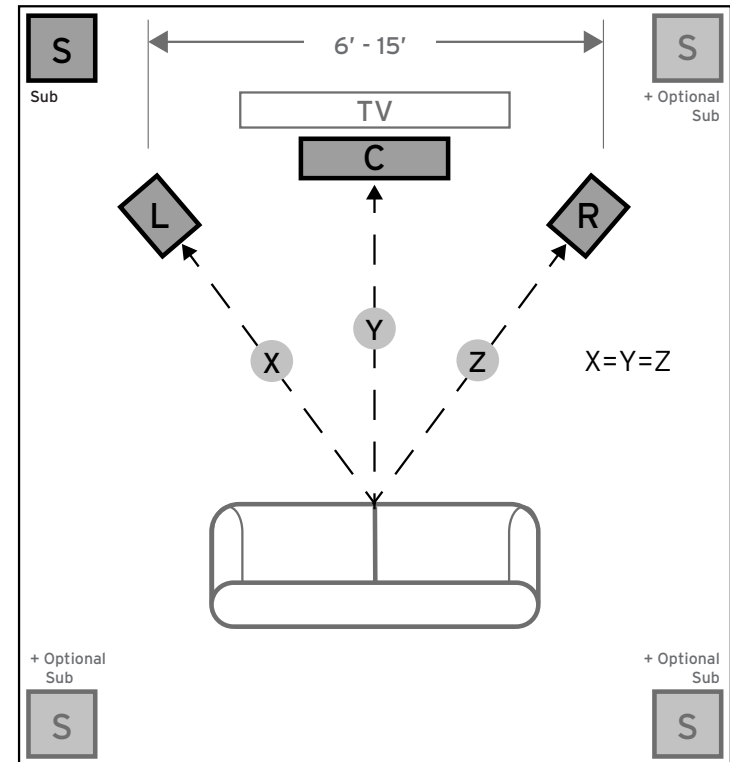
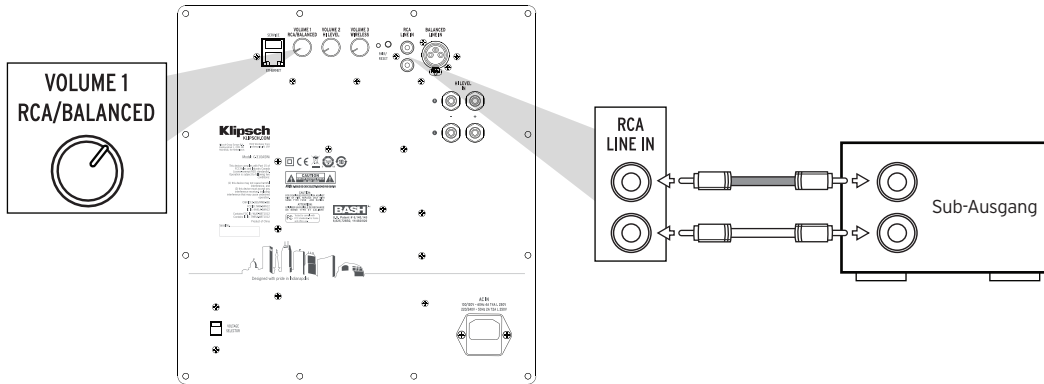
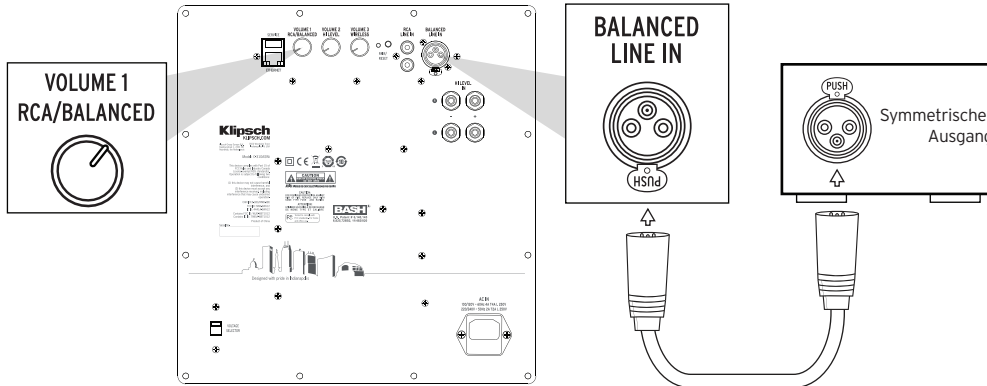

FIGURE 1
PLATZIERUNG DER LAUTSPRECHER IM HÖRBEREICH

UNSYMMETRISCHER EINGANG



SYMMETRISCHER EINGANG



HOCHPEGEL-EINGANG

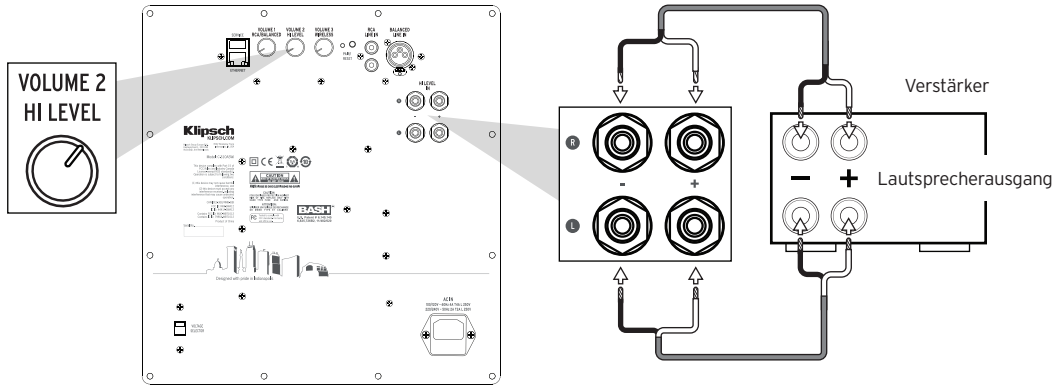

DRAHTLOSER EINGANG *WEITERE INFORMATIONEN FINDEN SIE IN DER DOKUMENTATION DES WA-3 KIT

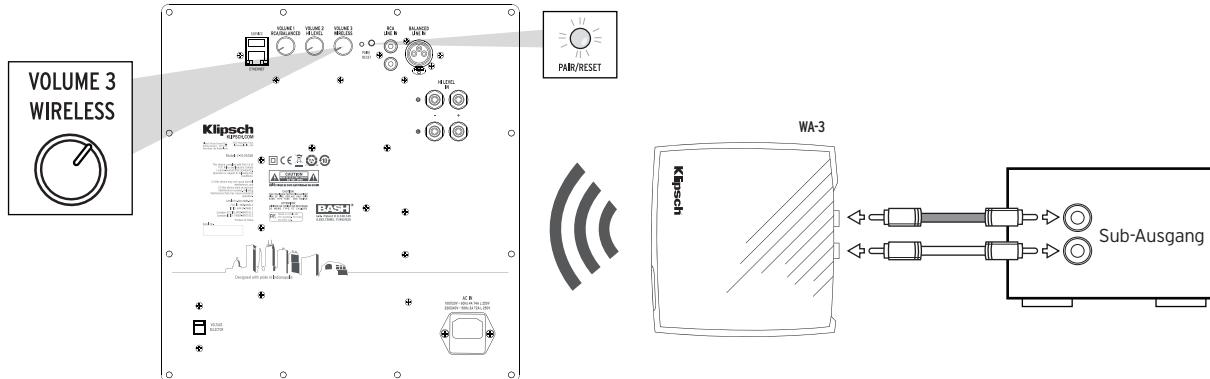

AUTOMATISCHE RAUMKORREKTUR

1. Starten Sie die Klipsch Low Control App
2. Klicken Sie auf „Auto Eq“
3. Folgen Sie den Anleitungen



IP-KONTROLLE / EINGANG

Kontrolltreiber sind unter klipsch.com/cseries erhältlich

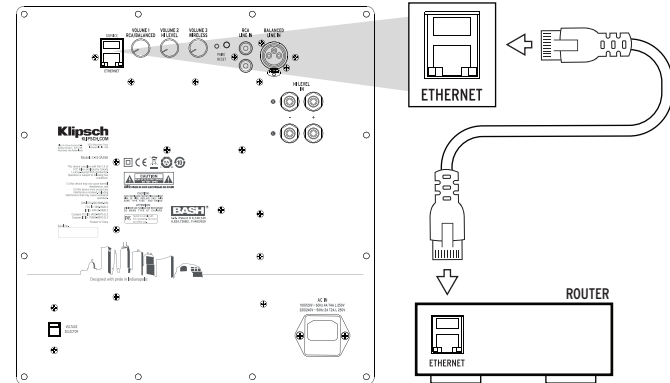

*Subwoofer verwendet standardmäßig DHCP

CONTENUTO

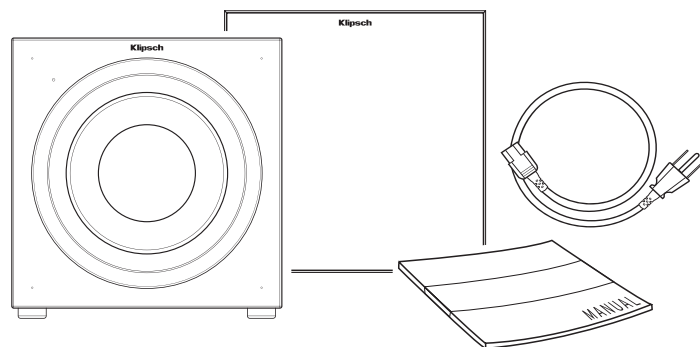

LOW CONTROL APP

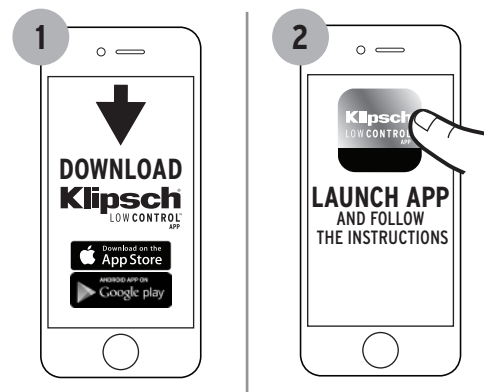

CURA E PULIZIA

Il subwoofer presenta una finitura che occorre solo spolverare o pulire con un panno asciutto. Evitare l'uso di detergenti abrasivi, a base di solvente o forti.

REGISTRAZIONE DEL PRODOTTO

Il prodotto può essere registrato on-line sul sito www.klipsch.com/register.

- Si riceveranno così informazioni su nuovi prodotti e promozioni.
- I dati personali degli utenti non saranno mai venduti.
- Le informazioni di registrazione non vengono utilizzate a scopi di garanzia.

Conservare la ricevuta per mostrarla in caso di reclami coperti dalla garanzia.

CONNESSIONI

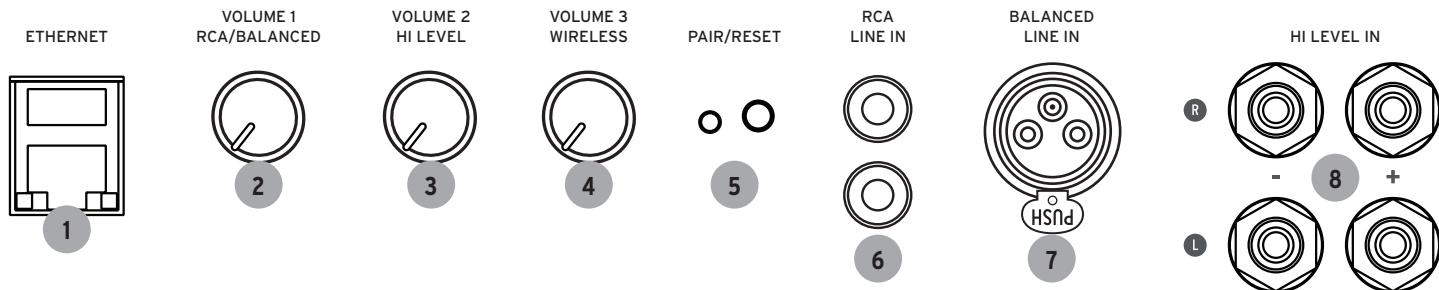

1 - Ingresso Ethernet per controllo IP	2 - Regolazione volume a livello di linea per regolare il volume dell'ingresso RCA e XLR	3 - Regolazione volume alto livello per regolare il volume dell'ingresso di alto livello	4 - Regolazione volume wireless per regolare il volume dell'ingresso wireless*
5 - Pulsante ASSOCIAZIONE / RIPRISTINO Per eseguire l'associazione a un trasmettitore wireless WA-3*	6 - Ingresso di linea sbilanciato RCA	7 - Ingresso di linea bilanciato XLR	8 - Ingresso di alto livello (livello altoparlante)

*Consultare il manuale del kit WA-3 per maggiori informazioni

LED ANTERIORE

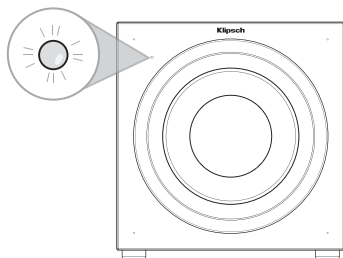

BIANCO	Acceso
BLU	Acceso, app collegata
ARANCIONE	Aggiornamento del firmware in corso
SPENTO	Standby

COLLOCAZIONE DEL SUBWOOFER

I subwoofer amplificati Klipsch® sono stati progettati per riprodurre i bassi profondi e offrire una resa sonora elevatissima sia con brani musicali che con i film. Per ottenere i migliori risultati, collocare il subwoofer in un angolo della stanza, presso la stessa parete accanto alla quale si sono disposti gli altoparlanti del canale anteriore (vedere la Figura 1). Tenere presente che il punto della stanza prescelto può avere un notevole effetto sulla resa sonora del subwoofer. Collocandolo in un angolo, come suggerito sopra, si aumenta il livello dell'uscita ai bassi, mentre se lo si colloca presso il centro di una parete o lontano dalle pareti si diminuisce tale livello. Provare a collocarlo in vari punti e a regolare i comandi su diverse posizioni fino a trovare la configurazione adatta alla stanza e alle proprie preferenze. Al momento di scegliere il punto in cui collocare il subwoofer, tenere presente che sarà necessario collegarne l'amplificatore incorporato a una presa di corrente.

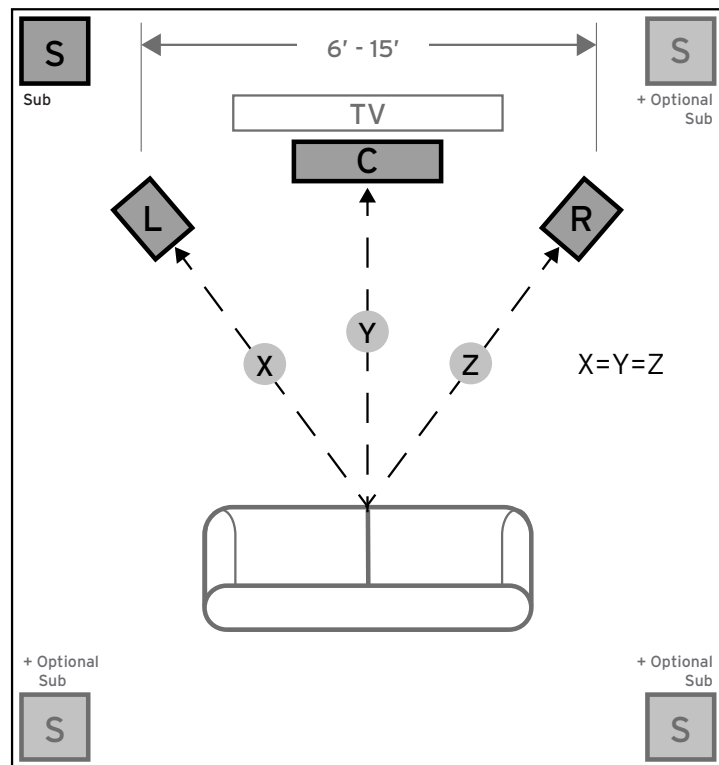
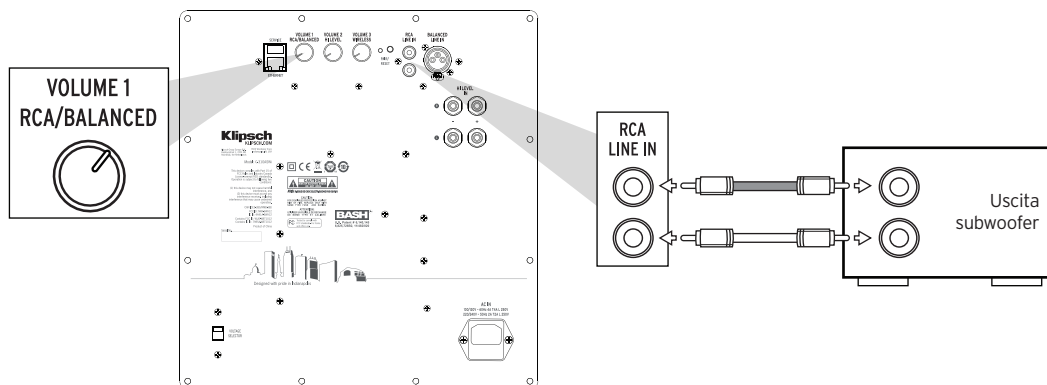
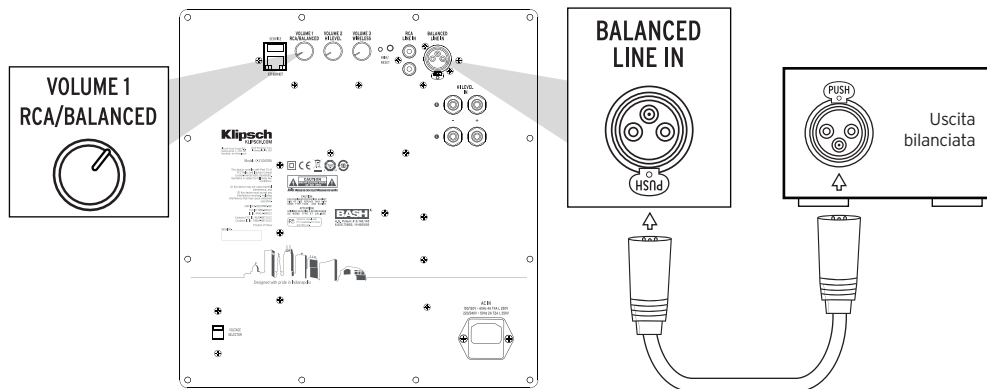

FIGURE 1
COLLOCAZIONE DEGLI ALTOPARLANTI NELL'AREA DI ASCOLTO

INGRESSO SBILANCIATO



INGRESSO BILANCIATO



INGRESSO DI ALTO LIVELLO

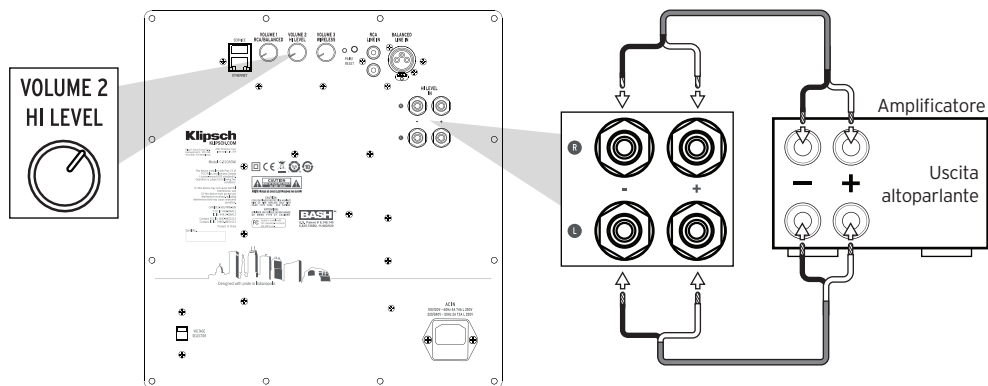

INGRESSO WIRELESS *CONSULTARE IL MANUALE DEL KIT WA-3 PER MAGGIORI INFORMAZIONI

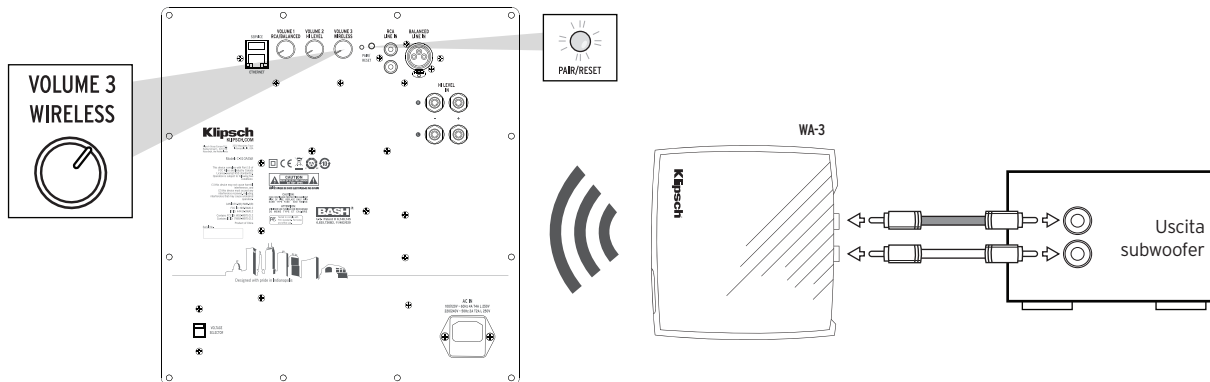

CORREZIONE AUTOMATICA IN BASE ALLA STANZA

1. Avviare la Klipsch Low Control App
2. Premere "auto eq"
3. Seguire le istruzioni



INGRESSO / CONTROLLO IP

I driver di controllo sono disponibili sul sito klipsch.com/cseries

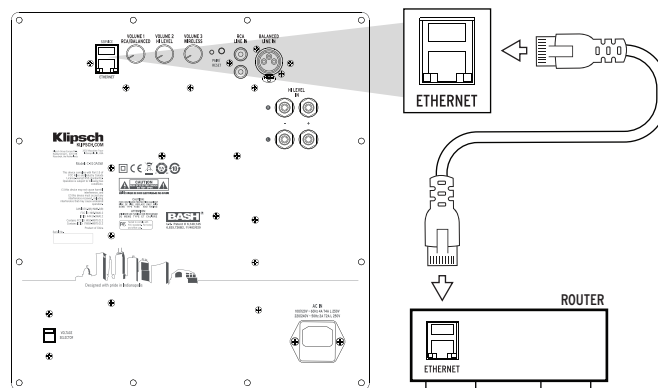

*Per impostazione predefinita
il subwoofer utilizza DHCP

CONTEÚDO

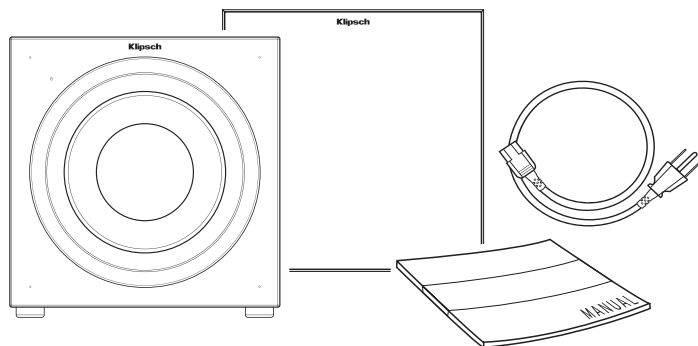

CUIDADOS E LIMPEZA

O subwoofer tem um acabamento que requer apenas a remoção de poeira ou limpeza com um pano seco. Evite usar produtos de limpeza abrasivos ou à base de solventes, bem como detergentes fortes.

LOW CONTROL APP

PORTUGUESE

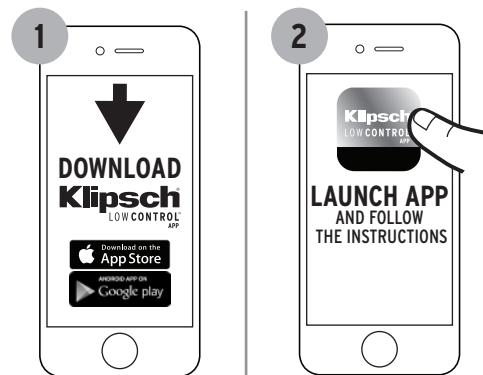

REGISTRO DO PRODUTO

Registre o produto on-line no site www.klipsch.com/register.

- Mantenha-se atualizado sobre novos produtos e promoções.
- Suas informações pessoais nunca serão vendidas a terceiros.
- As informações solicitadas para registro do produto não são usadas para fins de garantia.

Guarde uma cópia da nota fiscal ou recibo como comprovante para serviços cobertos pela garantia.

CONEXÕES

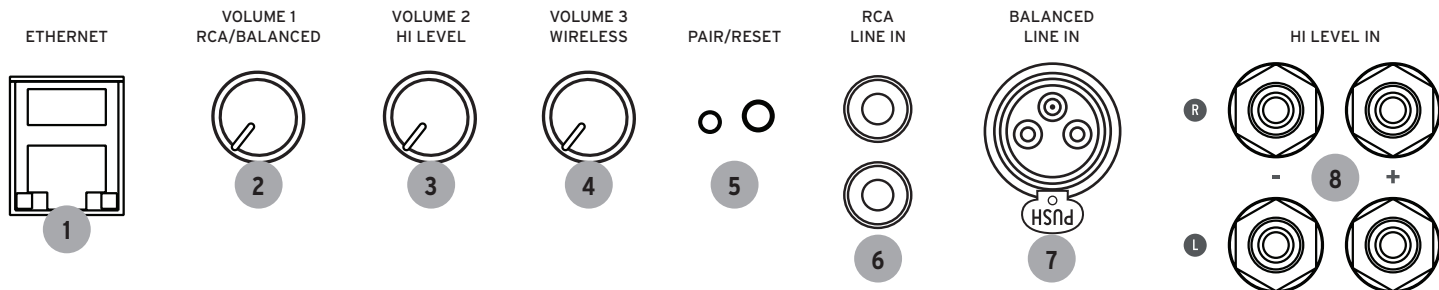

1 - Entrada Ethernet para controle de IP	2 - Controle de volume a nível de linha Controla o volume das entradas RCA e XLR	3 - Controle de volume de alto nível Controla o volume da entrada de alto nível	4 - Controle de volume sem fio Controla o volume da entrada sem fio*
5 - Botão EMPARELHAR/RESTAURAR Para emparelhar com o transmissor sem fio WA-3*	6 - Entrada de linha não balanceada RCA	7 - Entrada de linha balanceada XLR	8 - Entrada de alto nível (nível do caixa acústica)

*Consulte o manual do Kit WA-3 para obter mais informações

LED FRONTAL

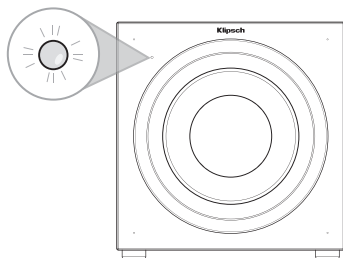

BRANCO	Ligado
AZUL	Ligado, aplicativo conectado
LARANJA	Atualização do firmware
APAGADO	Modo de espera

POSICIONAMENTO DO SUBWOOFER

Os subwoofers amplificados da Klipsch® são projetados para reproduzir graves profundos e produzir impacto que dá vida aos filmes e músicas. Normalmente, pode-se obter o desempenho ideal se o subwoofer for colocado em um canto do ambiente, na mesma parede que as caixas acústicas do canal frontal (veja a figura 1). Observe que o posicionamento pode ter um efeito profundo sobre o desempenho do subwoofer amplificado. Se a unidade for colocada em um canto, como sugerido acima, aumentará a reprodução de graves. Se for colocada no meio de uma parede, ou em um espaço aberto no ambiente, a reprodução de graves diminuirá. Experimente várias configurações de posicionamento e de controle para encontrar a mais adequada para o tipo de ambiente e sua preferência. Ao escolher a localização do subwoofer, não se esqueça de que será necessário ligar o amplificador integrado do subwoofer em uma tomada elétrica de CA.

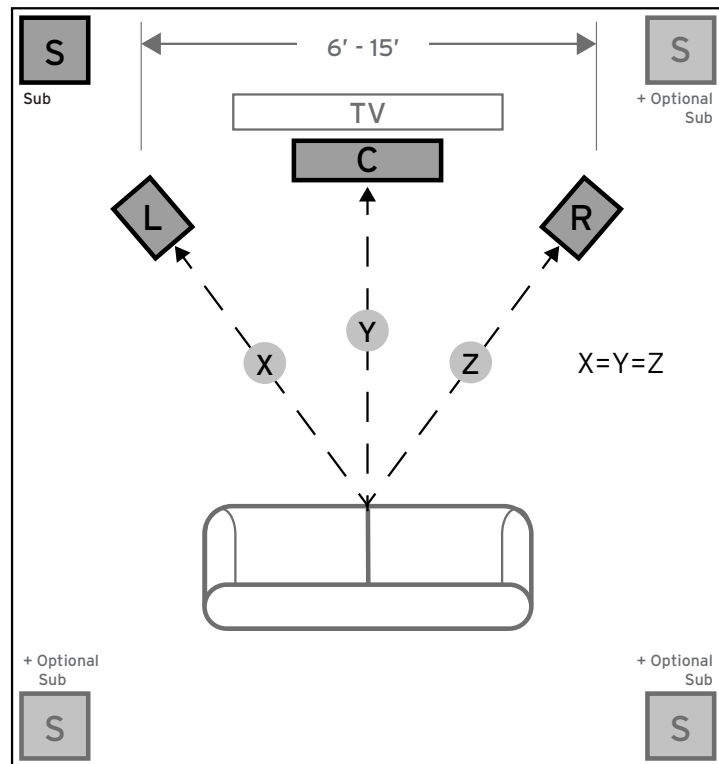
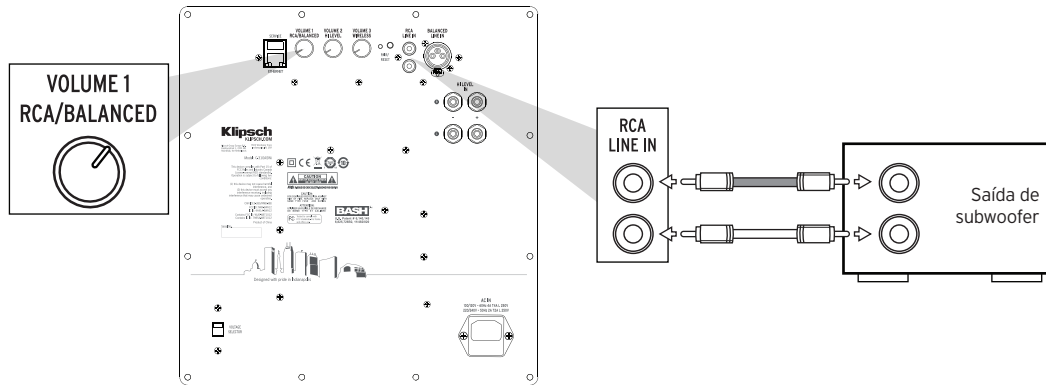
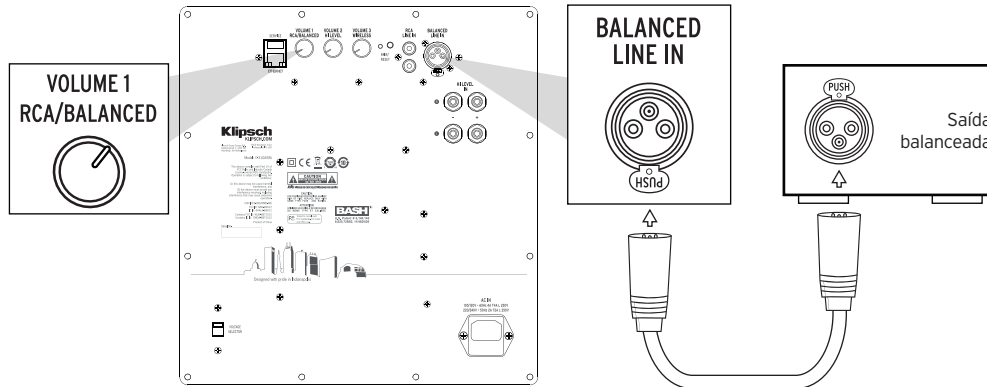

FIGURE 1
POSICIONAMENTO DAS CAIXAS ACÚSTICAS NO AMBIENTE

ENTRADA NÃO BALANCEADA



ENTRADA BALANCEADA



ENTRADA DE ALTO NÍVEL

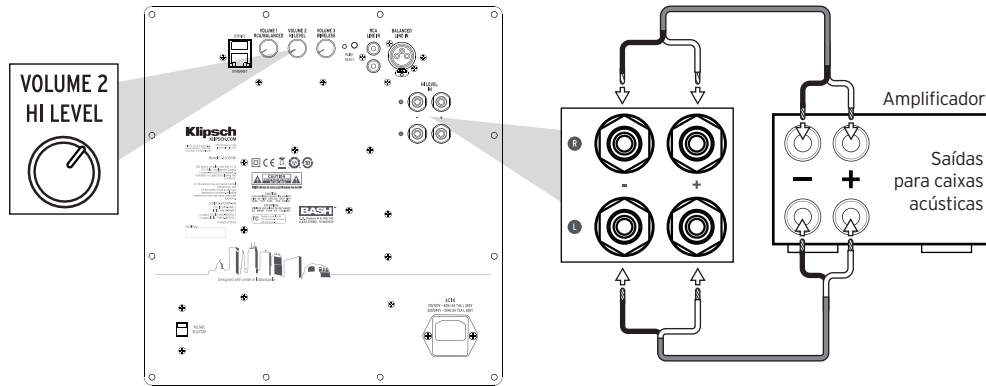

ENTRADA SEM FIO *CONSULTE O MANUAL DO KIT WA-3 PARA OBTER MAIS INFORMAÇÕES

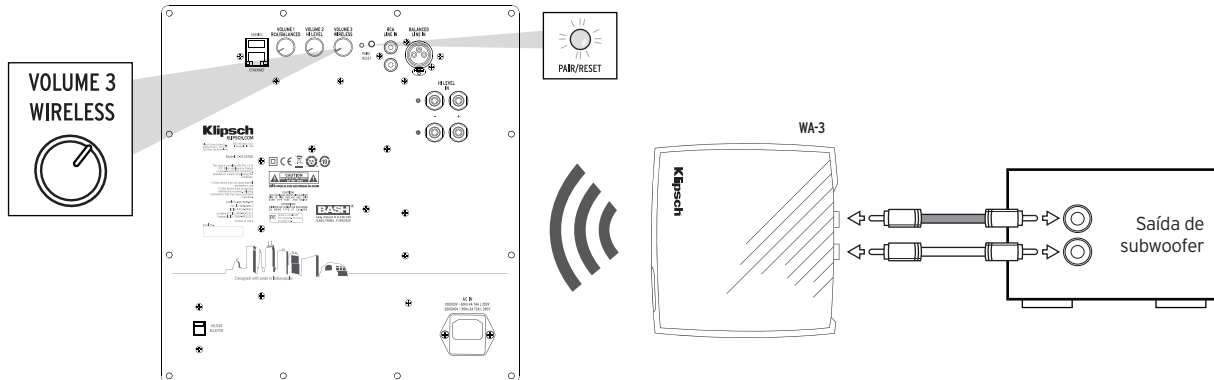

CORREÇÃO AUTOMÁTICA DE AMBIENTE

1. Inicie o Klipsch Low Control App
2. Pressione "auto eq"
3. Siga as instruções



CONTROLE/ENTRADA DE IP

Os drivers de controle estão disponíveis em klipsch.com/cseries

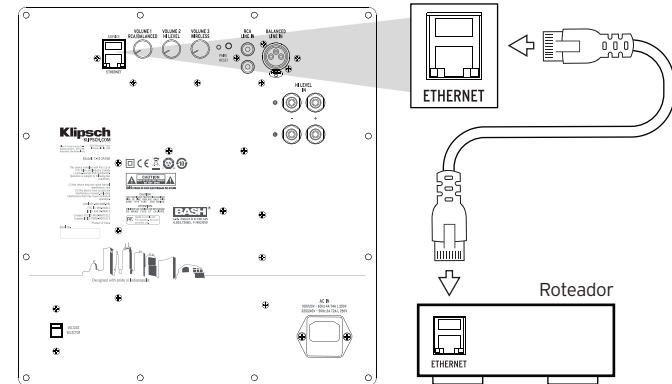

*O parâmetro padrão do subwoofer é DHCP

目录

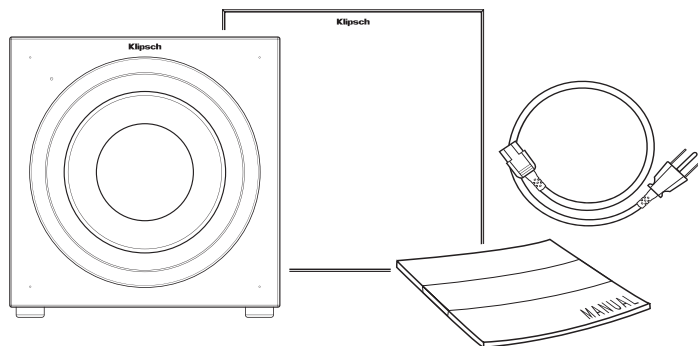

护理和清洁

本低音炮的表面只需要毛掸干除尘或用干布清洁。避免使用磨刮材料或溶剂型清洁剂和强洗涤剂。

LOW CONTROL APP

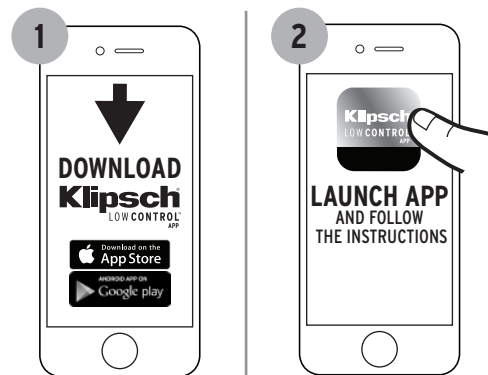

产品注册

在 www.klipsch.com/register 上注册产品。

- 获得新产品和促销的最新信息。
 - 你的个人信息永远不会被转售。
 - 本注册信息不用于保修目的。
- 请保留收据，以备保修索赔之用。

连接

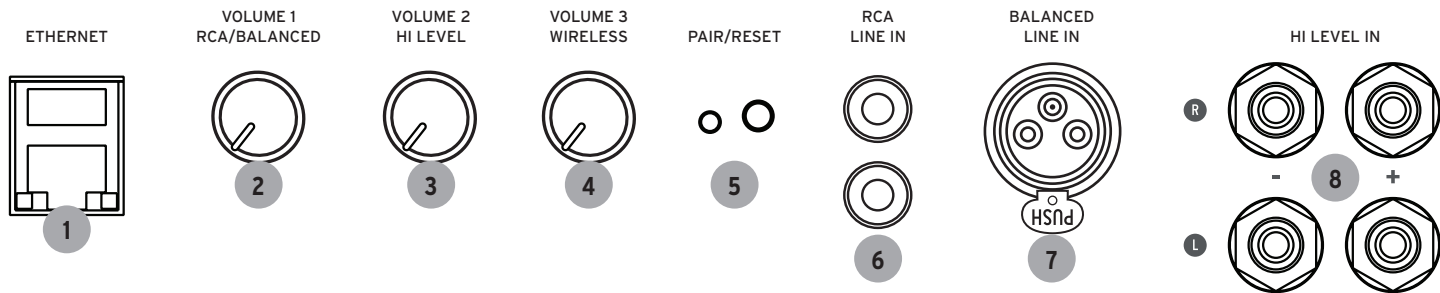

1. 以太网输入，用于 IP 控制	2. 线路电平音量控制，用于控制 RCA 音量和 XLR 输入	3. 高电平音量控制，用于控制高电平输入的音量	4. 无线音量控制，用于控制无线输入的音量*
5. 配对/重置按钮，用于与 WA-3 无线发射器进行配对*	6. RCA 不平衡线路输入	7. XLR 平衡线路输入	8. 高电平（音箱电平）输入

*更多信息，请参见 WA-3 工具包说明书。

前部 LED 灯

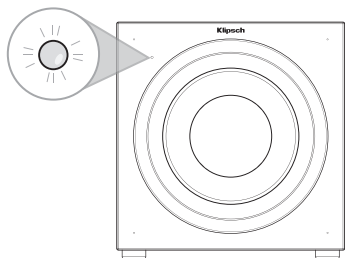

白光	通电
蓝光	通电，连接了应用程序
橙色	固件更新中
灭灯	待机

低音炮的安装位置

杰士®重低音炮能重现深沉的低音，使播放的电影和音乐栩栩如生。通常，如果把低音炮放在房间的一个角落，与前置音箱在同一个墙壁上，将会具有最佳的性能（参见图 1）。请注意，在房间里的放置位置可以对重低音炮的性能产生显著的影响。正如上面所建议的那样，放置在角落里将增加低音输出量，若将低音炮放置在墙壁中央，或在房间外面，将会减少低音输出量。尝试一些不同的放置位置和控制设置，找到一个最适合您的房间和品味的方案。当您选择低音炮的位置时，要记住您需要把低音炮的内置放大器连接到交流电源插座。

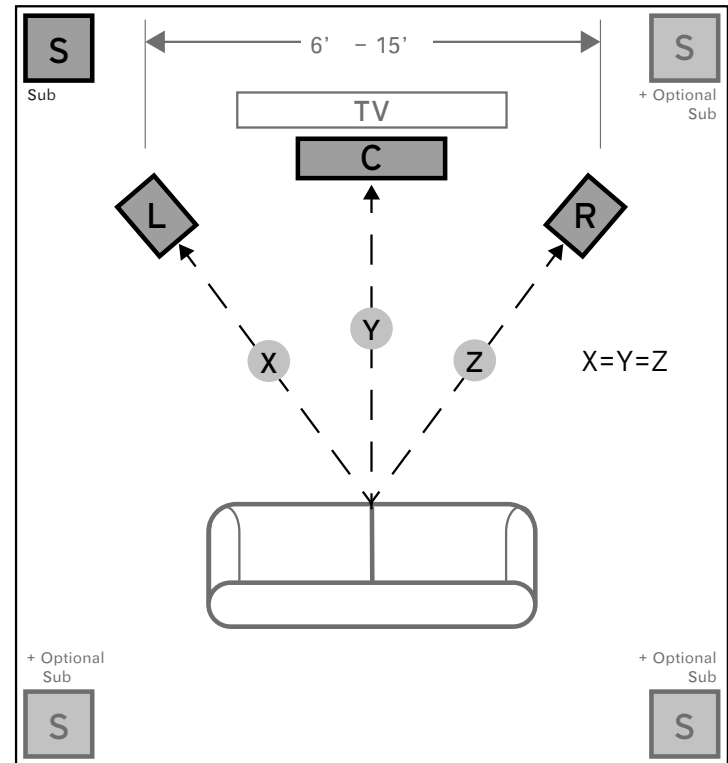
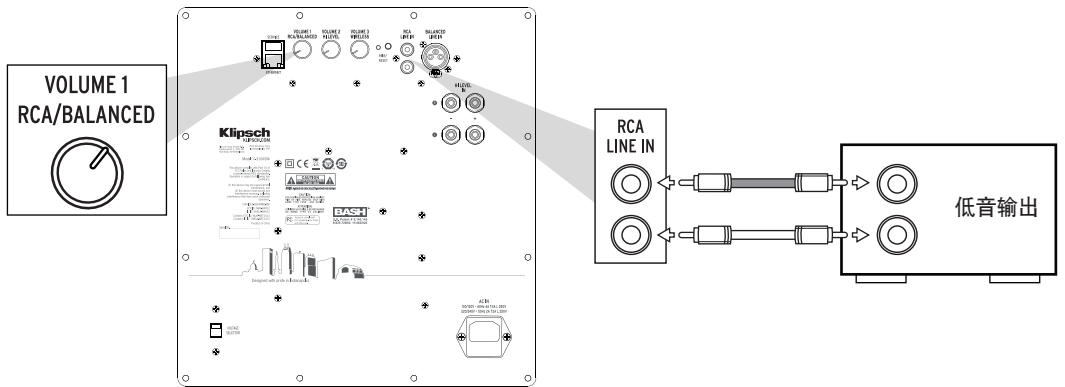
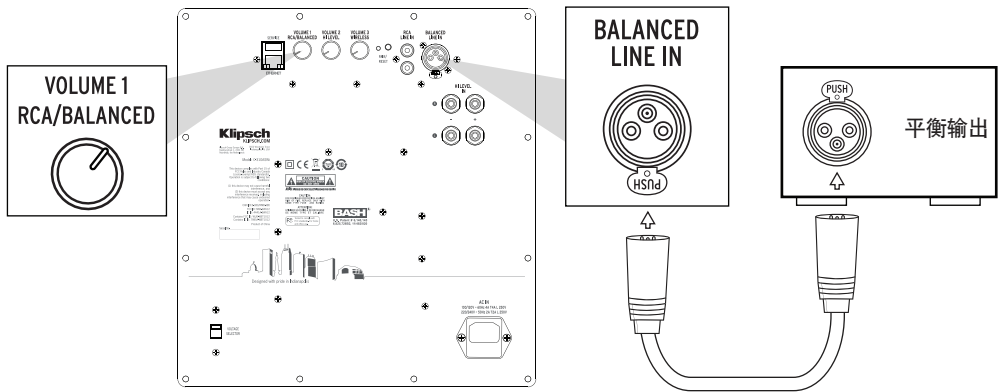

FIGURE 1
听音区的音箱放置AREA

不平衡输入



平衡输入



高电平输入

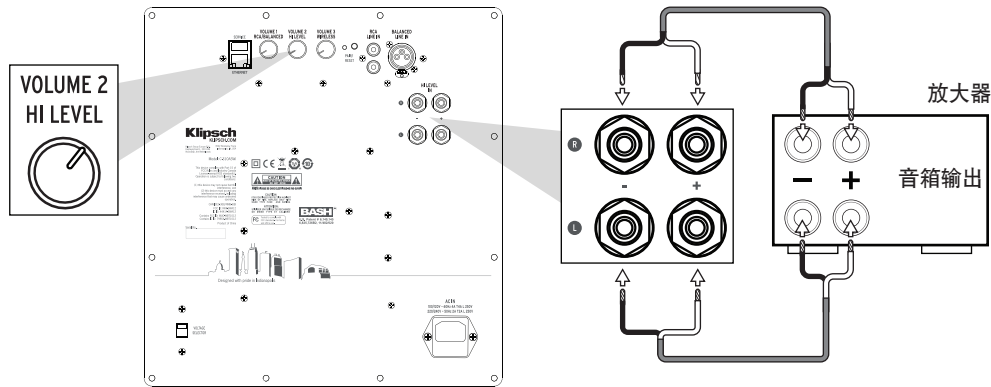

无线输入 *更多信息, 请参见 WA-3 工具包说明书。

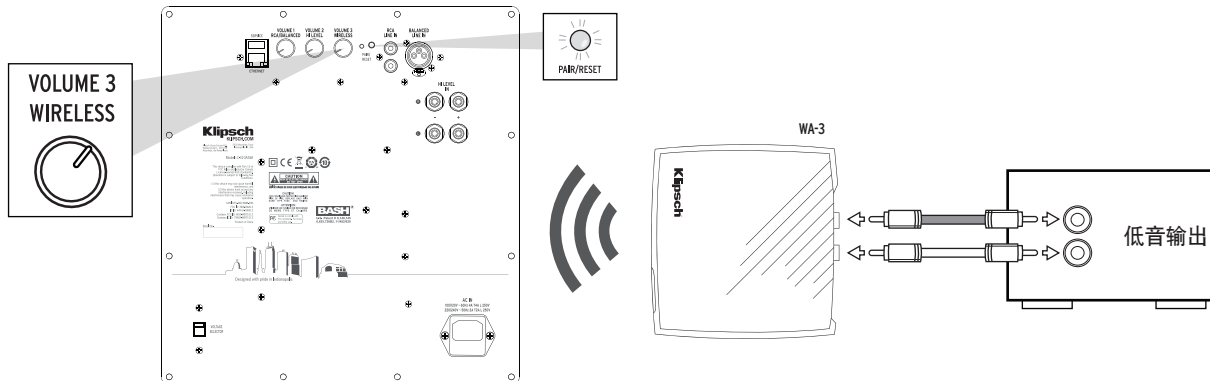

自动房间纠正

1. 运行杰士 Low Control App。
2. 按“自动均衡”（AUTO EQ）。
3. 按照指示进行操作。



IP 控制/输入

控制驱动程序可从 klipsch.com/cseries 下载。

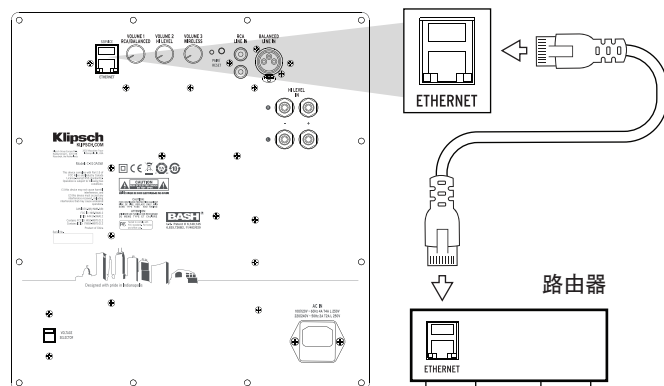

*低音炮默认设置为 DHCP。



Klipsch®

KEEPERS OF THE SOUND®

3502 WOODVIEW TRACE, INDIANAPOLIS, IN, USA

KLIPSCH.COM

V03-1024

1-800-KLIPSCH ©2014 KLIPSCH GROUP, INC. ALL RIGHTS RESERVED. KLIPSCH AND KEEPERS OF THE SOUND ARE REGISTERED TRADEMARKS OF KLIPSCH GROUP, INC. IN THE USA AND OTHER COUNTRIES.
A WHOLLY-OWNED SUBSIDIARY OF VOXX INTERNATIONAL CORPORATION.

