



THE SOUNDMAKERS

# LUCAS NANO

PROFESSIONAL SOUND TO GO >

LUCAS NANO 302 **NEW**

LUCAS NANO 305 FX **NEW**

LUCAS NANO 602

LUCAS NANO 605 FX **NEW**

LUCAS NANO 608i

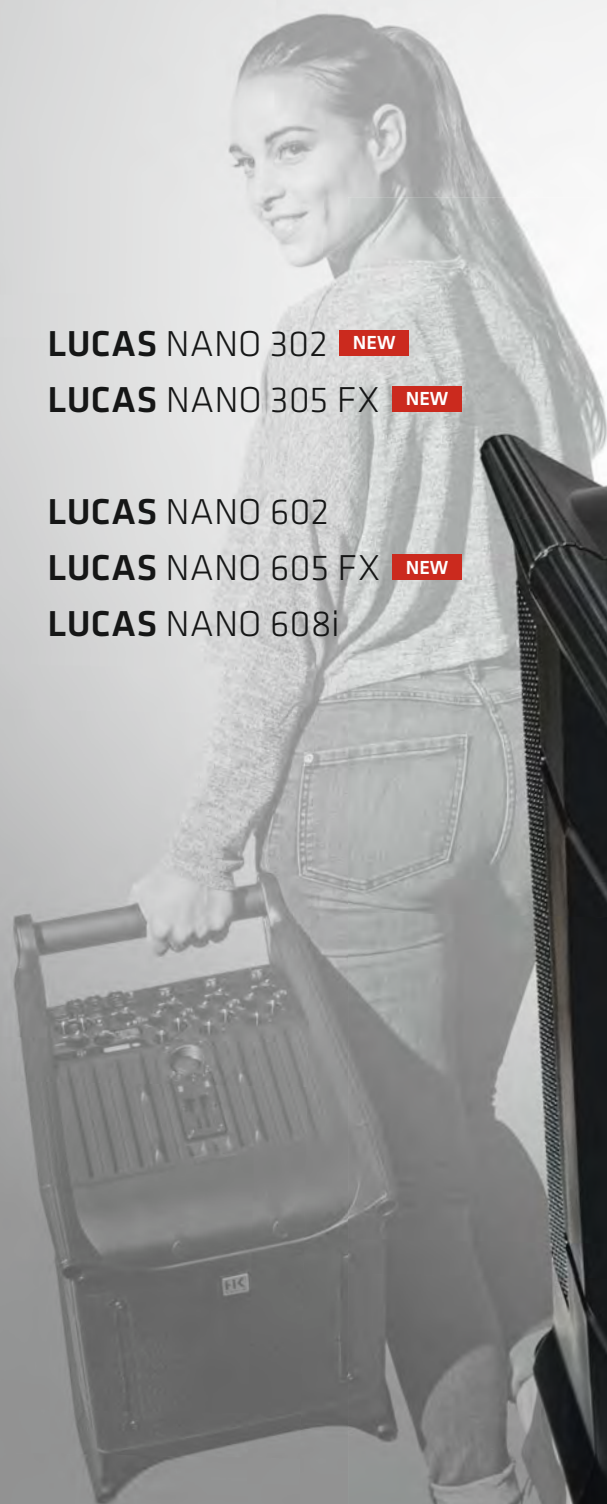



# LUCAS NANO

**PROFESSIONAL SOUND TO GO >**

LUCAS NANO is the only genuine stereo PA that can be carried in one hand. The new LUCAS NANO generation is made up of five different models across two power classes.

LUCAS NANO is a true all-rounder, whether it's as a front PA with your band for audiences of up to 200. An MP3 playback party sound system. An entertainer's stereo PA. An elegant mono solution for singer-songwriters. At home for live sports screenings or karaoke evenings. In the gym, pushing through the burn. Or at garden parties with friends. LUCAS NANO - make your world sound bigger!

## Using LUCAS NANO means:

- Your voice is rendered clearly and assertively, with excellent speech intelligibility all the way to the back row.
- Your DJ playlist will rock every party and will make everybody dance (the bass and beat of your music are delivered with power and punch so the energy can be felt throughout the room - your audience can't help but get up and dance)!
- Your keyboard sounds are amplified exactly as they should be, with their true, unadulterated tones remaining intact.
- The brilliance of your guitar is captured in a high-definition audio signal that delivers all its characteristic overtones to the far corners of the room.
- Every instrument and voice is well defined and readily discernible in the mix, thanks to the system's ample headroom and its ability to deliver richly detailed sonic images.



# FAMILY OVERVIEW

## LUCAS NANO 300 series

The LUCAS NANO 300 series consists of two different models: LUCAS NANO 302 and LUCAS NANO 305 FX.

They look, weigh and sound exactly the same – the only difference is the input section, where LUCAS NANO 305 FX offers a bunch of extra features.

LUCAS NANO 302



LUCAS NANO 305 FX



### LUCAS NANO 300 series specifications

- Peak power: 750 watts (calc.)
- Power rating: 230 watts (RMS)
- Frequency response: 44 Hz-20 kHz
- Max. SPL peak: 120 dB
- Audience: up to 80
- Bass woofer: 8" subwoofer (Celestion custom-made)
- Satellite speaker: 3.5" speaker (Celestion custom-made)
- Speaker connections: Speakon
- Subwoofer: 30 x 39 x 42 cm, 8.3 kg / 18.3 lbs.
- Satellite: 13 x 13 x 11.5 cm, 1 kg / 2.2 lbs.
- Weight: just 10.3 kg for the entire system!





## LUCAS NANO 600 series

There are three different models available: LUCAS NANO 602, LUCAS NANO 605 FX and LUCAS NANO 608i.

They all share the same astonishing audio performance and ingeniously portable chassis - they only differ in their input sections.

**LUCAS NANO 602**



**LUCAS NANO 605 FX**



**LUCAS NANO 608i**



### LUCAS NANO 600 series specifications

Peak Power: 1500 watts (calc.)  
 Power rating: 460 watts (RMS)  
 Frequency response: 43 Hz-20 kHz  
 Max. SPL peak: 130 dB  
 Audience: up to 120  
 Bass woofer: 10" subwoofer (Celestion custom-made)  
 Satellite speaker: Coaxially arranged 4.5" speaker + 1" tweeter (Celestion custom-made), with Multicell Transformer  
 Speaker connections: Speakon  
 Subwoofer: 35 x 49 x 47 cm, 13.9 kg / 30.8 lbs.  
 Satellite: 14.5 x 14.5 x 13.5 cm, 1.2 kg / 2.6 lbs.  
 Weight: just 16.3 kg for the entire system!

# SETUP OPTIONS

---

Unlike conventional column PA systems, LUCAS NANO can be set up in many different ways. In fact, LUCAS NANO's flexibility – and the comprehensive range of available accessories – make it perfect for a huge variety of event types and uses. Plus, you can set it up in seconds!

## Optimized for stereo system performance

If you're an entertainer, pianist, wedding DJ, or a singer or musician in a band, you can set up a high-quality, 2.1 stereo sound system in seconds. Simply screw the two satellites on to speaker stands and plug in speaker cords to connect them to the subwoofer.



## Excels as an elegant column-type system too

With just a few twists of the wrist, you can set up LUCAS NANO as a sweet mono system to do your thing as a singer-songwriter or speaker. With the optional signal-carrying S-Connect Pole LN accessory, you can bring the satellites to the desired height and aim them in the exact direction of your listeners. And all this with a tiny onstage footprint!



## If it has to be quick...

When you're in a real hurry (or not), attach the satellites right on top of the subwoofer. This is done in under five seconds. As the Easy-Click connector carries the signal between the sub and the satellite array, no external speaker cabling is needed. The system is immediately ready and can be discreetly placed anywhere in the room.



## Twin Stereo System: for twice the punch

If you need even more power to play bigger gigs, you can combine two LUCAS NANOs as a Twin Stereo System. This setup delivers professional PA sound with a maximum SPL of up to an impressive 136 dB – allowing you to easily cover audiences of up to 200 people.

What's more, a Twin Stereo setup not only delivers twice the power – it also gives you access to all the inputs on both LUCAS NANO units you're using (i.e. potentially up to 16, when using two LUCAS NANO 608i systems). One Link Cable is all you need to connect the two.

If you already own a LUCAS NANO, you can also upgrade to Twin Stereo at a later date. It doesn't matter which of the models within either the 600 or 300 series you combine – every combination will work, including the original LUCAS NANO 300 and LUCAS NANO 600 models themselves.

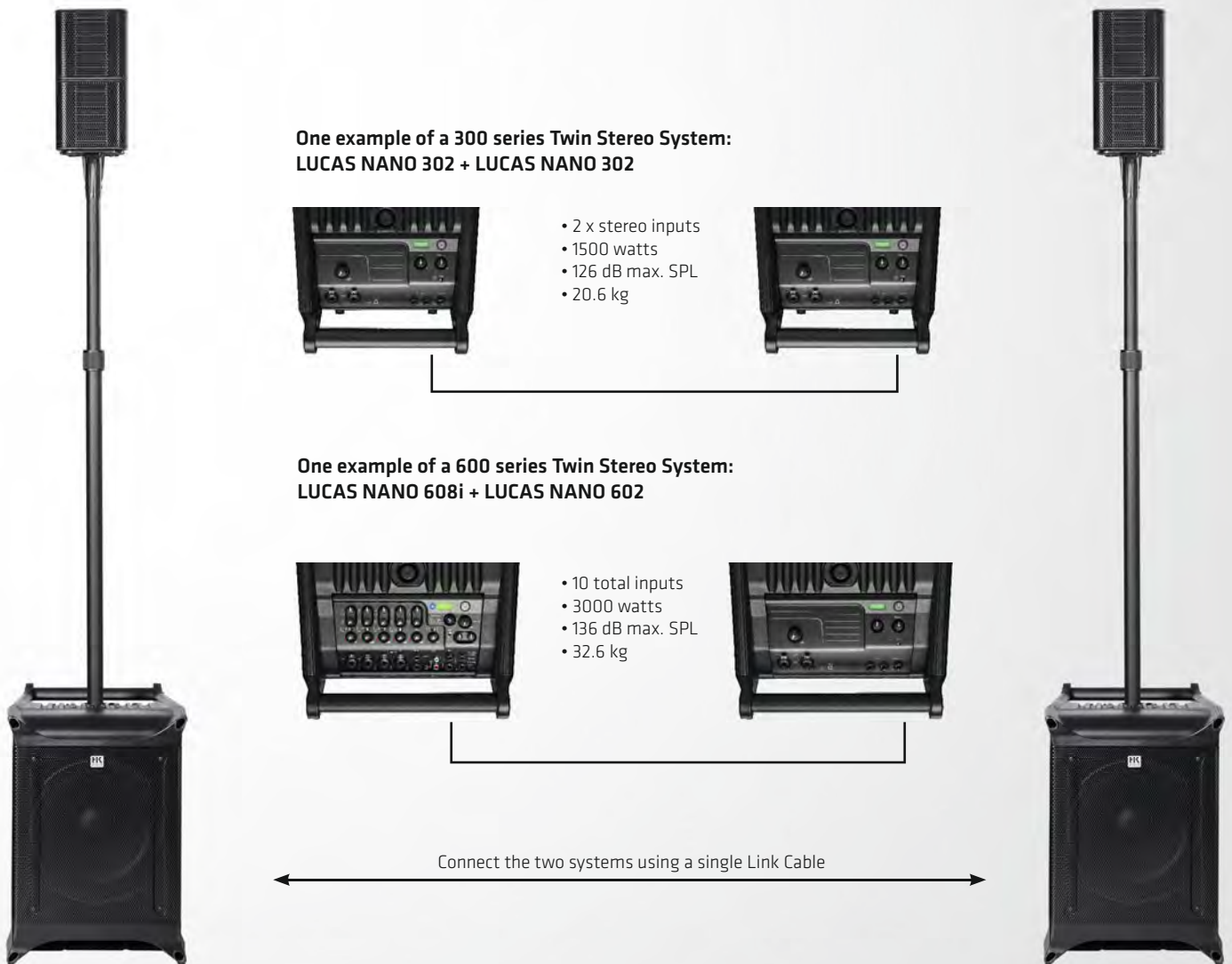

# SUGGESTED APPLICATIONS

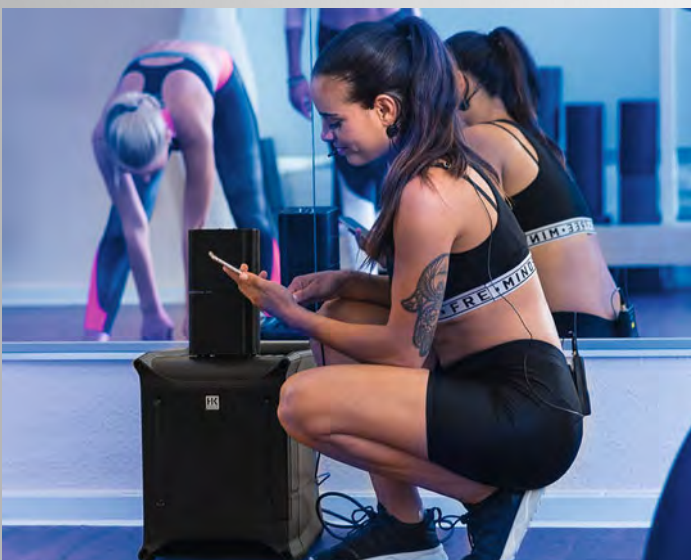







Speaker Out  
to Satellite

9/8

HK  
AUDIO

LUCAS  
NANO 605FX

OFF ON  
Phantom Power  
On 1/2 Mic

Setup

Speaker Out  
to Satellite

HK AUDIO  
LUCAS NANO  
LUCAS NANO  
500 Series  
Made in CE

# SYSTEM COMPONENTS

---

## The subwoofer

This powered bass bin houses a woofer and the system's electronic components, including the Class D power amps. The controls and ports are on the top-rear mounted control panel, and are well protected by the carrying handle. Below it are the speaker outputs and a cargo bay where the satellites stow away neatly for transport and storage.

On top of the enclosure is an Easy-Click guide rail with built-in signal-carrying terminals and a pole mount that is also able to route the signal. It serves to connect the optional S-Connect Pole LN distance pole and also accepts standard M20/35 mm speaker extension poles.

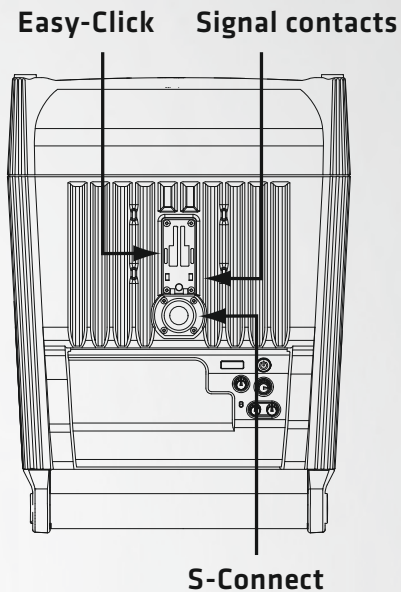

LUCAS NANO subwoofer

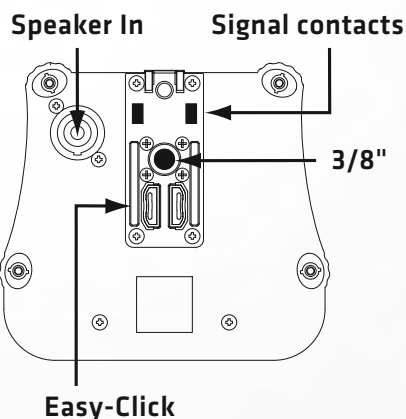

600 series satellite

## The satellites

Alongside the built-in speakers, each enclosure comes with a threaded insert for mounting the satellite on to off-the-shelf microphone stands. On the bottom of the enclosure is an Easy-Click guide rail with a built-in signal bus. It slots the satellites right on to the subwoofer or S-Connect Pole LN extension pole. On top of the housing is another guide rail that accepts two upside-down satellites.

Easy-Click is a snap-in locking mechanism that connects the two satellites physically as well as electrically to establish an audio link. It provides a cordless connection when the satellite is mounted on the subwoofer or S-Connect Pole LN extension pole.

# HANDLING

---

## Storing and transporting satellites

The satellites lock in place and are well protected in the transport bay at the back of the subwoofer. The transport latches have to be unfastened to remove the satellites. That's easy enough: simply unscrew the wing thumb screws on both sides of the housing to release the latches and lift the connected satellite pair up and out of the transport bay.



## Cordless convenience with Easy-Click and S-Connect

LUCAS NANO features an innovative signal bus that conveys the speaker signals internally from component to component, so there's no need for speaker cords.



## Standalone or stacked

The two satellites can also be stacked. On top of the housing is another guide rail that takes two upside-down satellites. This creates mechanical, audio and acoustical connections, coupling the components to form a single unit.

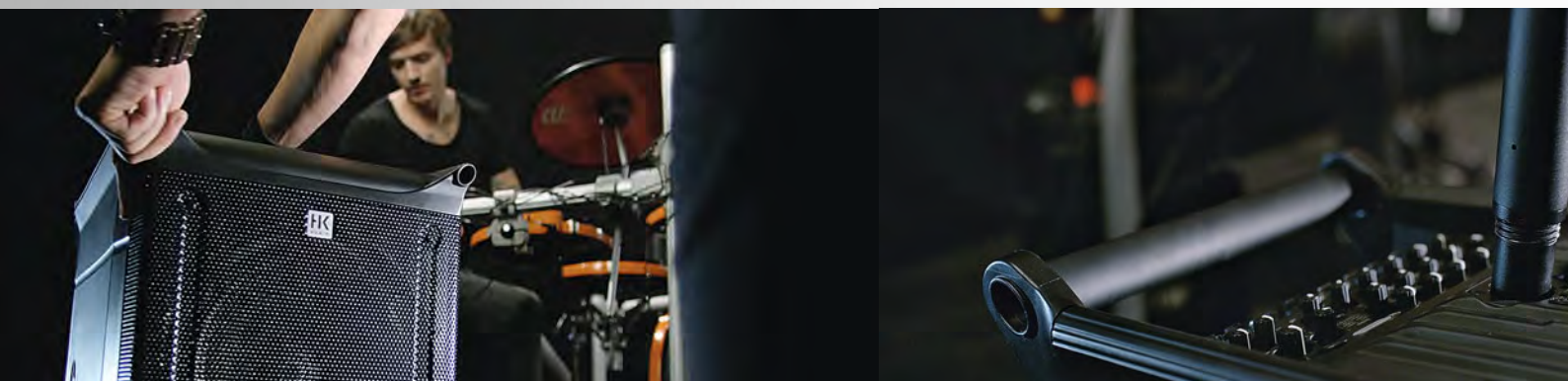

## Stereo link – just one cable

Two LUCAS NANO units can be doubled up to create a more powerful Twin Stereo System. This gives you twice the output power, as well as control over all inputs on both LUCAS NANO units.

This is how it works: in Twin Stereo Mode, the left LUCAS NANO (see picture) feeds the right side of its stereo mix to the right LUCAS NANO – and gets the left side of the right LUCAS NANO's stereo mix in return. So whenever you make a change on the left NANO, you hear it on both speaker systems simultaneously.

The Volume and Master controls on each LUCAS NANO determine the overall volume of the master mix – that is, all the channels that have been blended to a composite signal in that system – to be rendered by the Twin Stereo System.

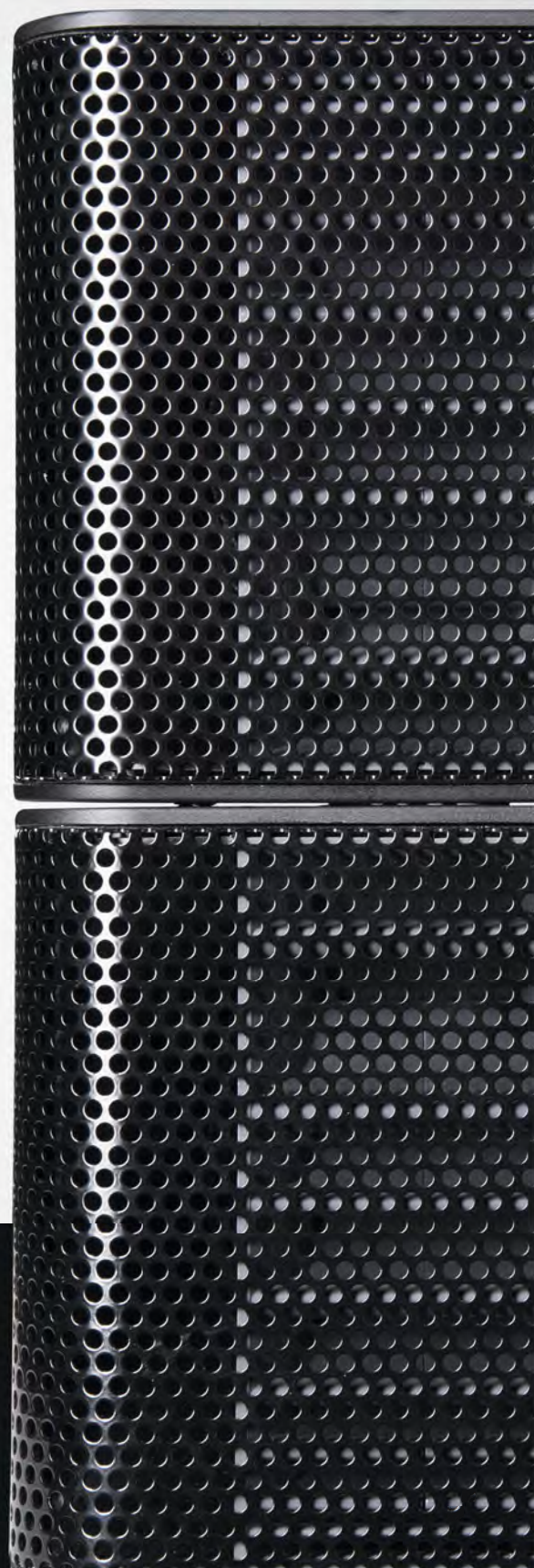
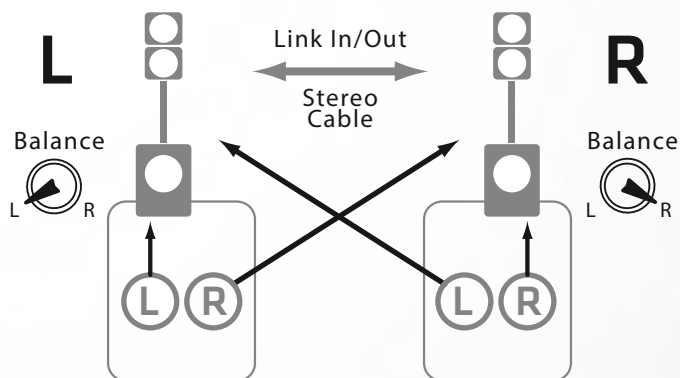

# THE ART OF GERMAN ENGINEERING

There are a few things that set LUCAS NANO apart from the competition. First, the performance. LUCAS NANO delivers balanced, assertive sound and precise, punchy low bass response, rendering the entire frequency spectrum with remarkable consistency. The satellites send the sonic energy precisely to where it needs to go: to your audience.

The subwoofer enclosure is tuned to deliver clean, powerful and surprisingly low-ranging bass response. All LUCAS NANO speakers are custom-made by the world-renowned loudspeaker manufacturer Celestion. This is the only way we can guarantee the best sound quality and performance reliability needed from a genuine PA system.



*Cross-section of a LUCAS NANO 300 series subwoofer*

Small housings have many benefits, but they've never been famous for delivering ultra-low frequencies. So we took a novel approach to this challenge and designed the Subfire Port. This bass reflex channel is located at the very bottom of the housing to use the floor as an extension of the reflex port for deep bass down to 44 Hz. A 5 mm aluminum plate is part of the Subfire Port and serves to cool the power amp and brace the housing. Efficiency at its best!

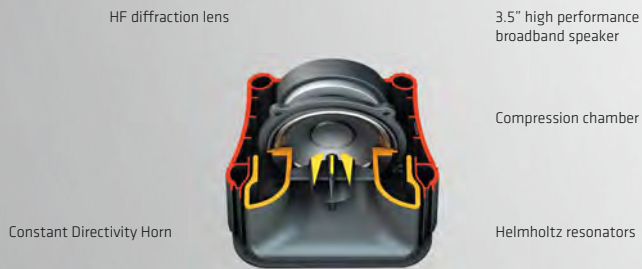

*Cross-section of a LUCAS NANO 300 series satellite*

The satellite features a 3.5" high-performance broadband speaker mounted in a compression chamber. A Helmholtz resonator increases low mids by +6 dB. The Constant directivity horn increases mids and highs by +4 dB and features a high frequency diffraction lens for perfect dispersion.

Signal-carrying threading for S-Connect Pole LN or M20 poles

10" high performance subwoofer

Anti-Resonance Bracing

Bass reflex port

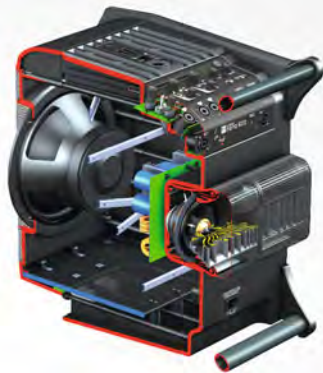

Control and input panel

Satellite transport bay

Class D system power amp

Low-resonance polypropylene housing

The 600 series subwoofer is a 10" high performance bass chassis, driven by a powerful Class D amplifier with plenty of power and enough headroom to also handle untreated signals.

*Cross-section of a LUCAS NANO 600 series subwoofer*

Multicell Transformer lens

Nine horn channels

Wavefront

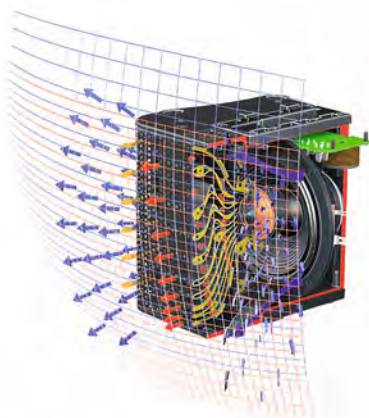

4.5" mid/high speaker

1" HF driver

Compression chamber

Helmholtz resonators

The satellites are loaded with a 4.5" broadband speaker and a 1" horn in coaxial array. The speakers are fronted with an acoustic lens – HK Audio's proprietary Multicell Transformer – that delivers higher sound pressure, less distortion and enhanced directivity.

*Cross-section of a LUCAS NANO 600 series satellite*

## Multicell Transformer

The pioneering Multicell Transformer (MCT) delivers the quality performance of a large high-frequency horn at a fraction of the size. The MCT splits the wavefront into nine smaller wavefronts. Each of these partial waves is directed through the flaring duct of a horn of different length and mouth size. This increases useful sound pressure by up to 10 dB. The mouths of the nine horn channels form a line array, with sound traveling down channels of different lengths to achieve different delay times. This yields a perfect vertical curve and a very precise pattern of throw. This ingenious invention makes the most of horns' and waveguides' physical advantages, with none of the drawbacks! The top end remains clear and clean. The satellites send the sonic energy precisely to where it needs to go: to your audience.







# LUCAS NANO 302

## LUCAS NANO 302

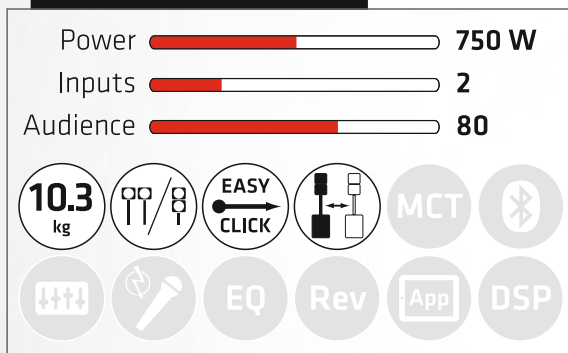

LUCAS NANO 302 is the perfect sound system for anyone looking to amplify line level signals: from MP3 players and notebooks, to mixing consoles, keyboards and more. Small, flexible and feather-light at just 10.3 kg, LUCAS 302 can easily be carried in just one hand and is built up and ready to go in seconds, whatever the situation.

LUCAS NANO 302 consists of an active system subwoofer and two satellites, which are stored in the subwoofer's transport bay. The system offers numerous setup possibilities: optimized for use as a 2.1 stereo system, it can also be combined with any other 300 series LUCAS NANO unit to form an even more powerful Twin Stereo System. In mono setup, LUCAS NANO 302 can be used as a compact mono-cube – with the satellites directly attached to the top of the subwoofer via HK Audio's Easy-Click technology – or as an elegant column system using the cable-free, height-adjustable S-Connect Pole LN distance pole (available separately).



# LUCAS NANO 602

## LUCAS NANO 602

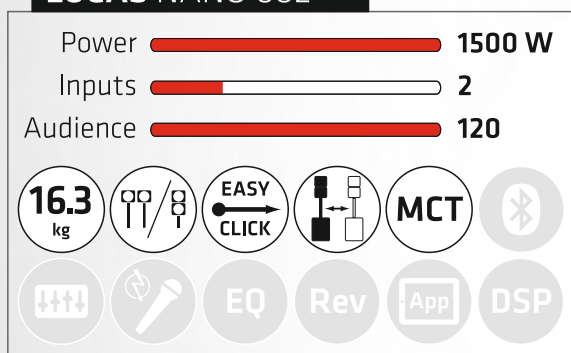

LUCAS NANO 602 is the perfect sound reinforcement solution for any musician, DJ or entertainer who wants to use their own external mixer. Other devices like DJ controllers, keyboards or playback devices are also easy to hook up.

This 2.1 stereo system is optimized for fast deployment at events attended by up to 120 people. LUCAS NANO 602 is also ideal as the second unit in a powerful Twin Stereo System setup in conjunction with any other 600 series LUCAS NANO. This lightweight, 16.3 kg / 36 lbs. system is easily carried in just one hand and ready for use in seconds flat.



# LUCAS NANO 302 / LUCAS NANO 602

Less fuss, more mojo! This is the successful LUCAS NANO format in its most streamlined form. Powered compact PA systems, these featherweights pack a heavyweight punch, setting up in seconds and delivering great sound in mono or stereo. Unlike their siblings, the LUCAS NANO 302 and 602 come without a mixer on board, making them the perfect choice if you prefer to work with an outboard console. What's more, the 302 and 602 models are the ideal add-on if you wish to upgrade your LUCAS NANO to a more powerful Twin Stereo System.

More information and detailed explanations about the settings can be found in the manual.

The Volume knob controls the overall level of the system



The 1/2 stereo input can handle both balanced line level signals and multimedia signals from smartphones, MP3 players or computers

The dual-color Status Indicator indicates power on/off and limiter activity



Sub controls the subwoofer's level. Balance adjusts the relative levels between the left and right satellite speaker

Setup toggles between mono and stereo system setups

The Link In/Out port is used to connect a second LUCAS NANO unit for a Twin Stereo System setup

Thru 1/2 passes the input signals through, to act as a Direct Out or to feed another device, such as a monitor or recording interface

# LUCAS NANO 305 FX

## LUCAS NANO 305 FX

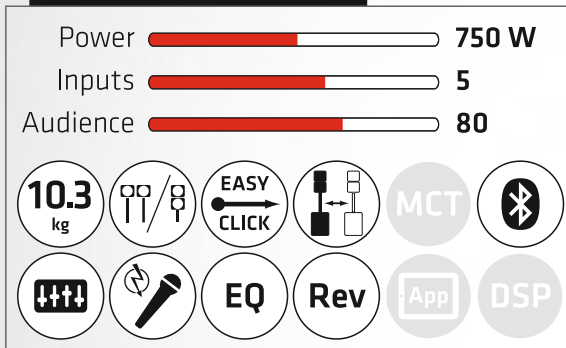

LUCAS NANO 305 FX is the world's smallest and lightest professional stereo sound system. The 305 FX is a true all-rounder, featuring a 5-channel mixer, Bluetooth Audio Streaming and integrated reverb effects. The 10.3 kg system has the best sound-to-volume ratio on the market – the powerful bass and hi-fi sound at high SPL make listeners who can't see the 305 FX imagine they're experiencing a far larger and heavier system.

The compact 305 FX's main calling card is its incredible flexibility and intuitive ease of use: simply connect an MP3 player via Bluetooth, a microphone, a guitar, or a keyboard, and you're ready to go. This makes LUCAS NANO 305 FX the ideal companion for many different sound system situations: be it for small acoustic concerts, as a party PA, karaoke evenings, barbecue parties with friends, Zumba courses in the gym or for background music and announcements at small events.



# LUCAS NANO 605 FX

## LUCAS NANO 605 FX

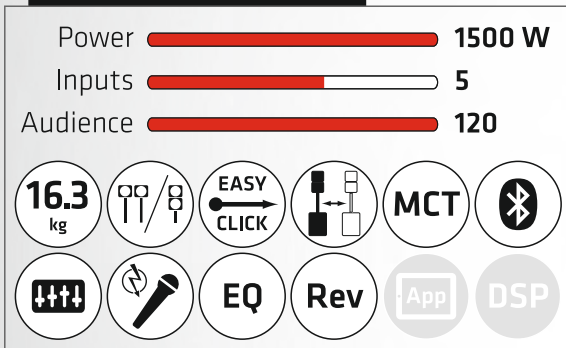

With its five inputs, Bluetooth Audio Streaming and on-board reverb effects, the 605 FX is a true all-rounder, whether it's as a front PA with your band for audiences of up to 120. An MP3 playback party sound system. An entertainer's stereo PA. An elegant mono solution for singer-songwriters. At home for live sports screenings or karaoke evenings. In the gym, pushing through the burn. Or at garden parties with friends.

Like all 600 series LUCAS NANO systems, the 605 FX impresses with high-resolution, powerful sound that offers high speech intelligibility and powerful deep bass – and all with a system weight of just 16.3 kg. It is optimized for plug and play use as a 2.1 stereo system, and in combination with any other 600 series LUCAS NANO as a powerful Twin Stereo System setup. Mono setups are also built up and ready to go in seconds.



# LUCAS NANO 305 FX / LUCAS NANO 605 FX

LUCAS NANO 305 FX and LUCAS NANO 605 FX are the go-to rigs for gigging musicians. Keyboards, microphones, acoustic guitars, and MP3 or CD players can simply be plugged straight in. With five inputs, impressive built-in reverb programs and intuitive EQ controls, there is no need for an external mixer. Plus, during breaks, interval music can be streamed via Bluetooth.

More information and detailed explanations about the settings can be found in the manual.



Low and Hi EQ knobs to shape the sound

Rev/Aux knobs to adjust the amount of reverb on each channel

Input select switches for microphones, instruments (e.g. guitars or basses) or line level signals (e.g. keyboards). Channels 1 and 2 can be phantom-powered for condenser mics or active DI boxes

Gain/Volume control for every channel

5 inputs for a variety of connections

Channels 2 and 3 can be stereo linked for stereo line sources (e.g. a keyboard or DJ controller)



Channel 4/5 is ready for Bluetooth audio streaming



Choose between 7 different reverb presets, or deactivate the internal reverb to use an external FX unit instead

Master Volume controls the overall level of the system

Sub controls the subwoofer's level. Balance adjusts the relative levels between the left and right satellite speakers

Connect a footswitch to remotely switch reverb on or off. This jack can also be used to drive an external FX unit or to build an individual monitor mix

The Link In/Out port is used to connect a second LUCAS NANO unit for use as a Twin Stereo System

Channel 4/5 can be set to thin out boomy signals like bassy keyboards

Balanced outputs to forward the complete mix or to act as a Thru Out for Ch 4/5 (e.g. keyboard Direct Out)



# LUCAS NANO 608i

## LUCAS NANO 608i

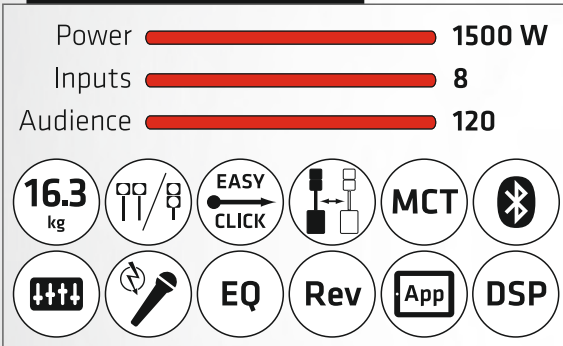

A full-blown PA system consisting of a mixing console, power amps, subwoofer and satellites – all with just one cord? Can this be real? The answer is yes: with LUCAS NANO 608i, it is reality! Despite its almost cable-free convenience, the 608i is one of the most flexible all-in-one PA solutions around, transforming into a classic stereo system or a slim mono setup to meet your needs.

You can even pair it with another 600 series LUCAS NANO to configure an impressive and powerful Twin Stereo System. And best of all, the 608i system weighs just 16.3 kg and is supremely easy to transport and store when not in use.

If you own an iPad, you can also control LUCAS NANO 608i remotely from the stage using the free LUCAS NANO REMOTE App for iPad. The App gives you professional audio tools to tweak your setup and fine-tune individual channels simply by “drawing” EQ curves with your finger. A click is all it takes to save Channel settings and even the overall setup in the App – for easy and total recall at the next gig.



# LUCAS NANO 608i

The all-in-one LUCAS NANO: eight inputs, eight-channel digital mixer, on-board reverb effects, remote controllable via a comprehensive App for iPad, intuitive EQ and compressor functions, and Bluetooth Audio Streaming. LUCAS NANO 608i is a dream come true if you want a fully-featured professional audio setup that you can transport with just one hand.

More information and detailed explanations about the settings can be found in the manual.



Contour controls with two different styles of sound-shaping EQ

Rev/Aux knobs to adjust the amount of reverb on each channel

Input select switches for microphones, instruments (e.g. guitars or basses) or line level signals (e.g. keyboards). Channels 1 and 2 can be phantom-powered for condenser mics or active DI boxes

Gain/Volume control for every channel. Clip LED shows input overloads

8 inputs for a variety of connections

Channels 3 and 4 can be stereo linked for stereo line sources (e.g. keyboards or DJ controllers)



Choose between 7 different reverb presets, or deactivate the internal reverb to use an external FX unit or to connect an active monitor instead

Master Volume controls the overall level of the system

Sub controls the subwoofer's level. Balance adjusts the relative levels between the left and right satellite speakers

Connect a footswitch to remotely switch reverb on or off. This jack can also be used to drive an external FX unit or to build an individual monitor mix

The Link In/Out port is used to connect a second LUCAS NANO unit for use as a Twin Stereo System

Balanced outputs to forward the complete mix or to act as a Thru Out for Ch 3/4 (e.g. keyboard Direct Out)

# PROFESSIONAL DIGITAL MIXER

LUCAS NANO 608i is a powerful PA system with plenty of knobs to control all the vital functions. But underneath its housing, it has even more to offer: a bunch of DSP features you can make use of by using the free LUCAS NANO REMOTE App for iPad!

With the LUCAS NANO REMOTE App for iPad, you enter a completely new world: the world of remote control. You don't just get to remotely manipulate LUCAS NANO 608i's physical controls – you also get access to all the extra DSP tools underneath the 608i's hood, like a low cut filter, 4-band EQ, compressor and panorama controls for each channel. Then there's a graphic Master EQ, and the possibility to store and recall full mixer scenes. And it's all available in either in Easy or Expert Mode – for beginners and PA pros alike.

The LUCAS NANO REMOTE App was designed to be as clear and easy to understand as possible, to guarantee intuitive handling. The App is made up of three main pages – Master, Mixer and Channel.



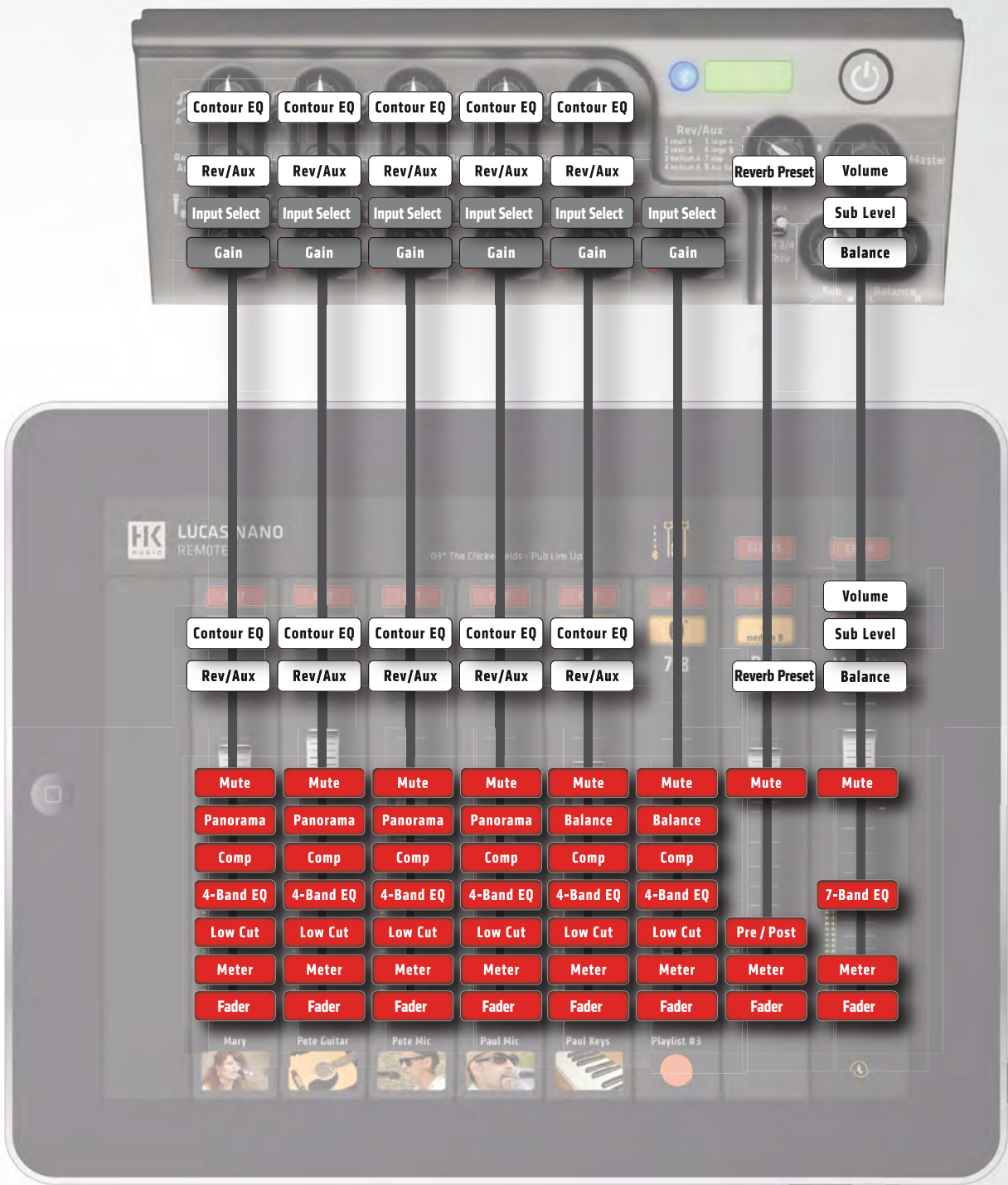

Hardware Controls

Controls via App

- Properties that can be controlled either on the hardware itself or remotely using the App
- Properties that can only be controlled on the hardware itself
- Properties that can only be controlled remotely using the App for iPad

# LUCAS NANO REMOTE APP FOR LUCAS NANO 608i

## 1. Mixer Page



### Convenient mixing

- Large faders for sensitive and precise volume control
- Big mute buttons allow quick channel muting in high-pressure situations
- High resolution real-time LED bars for reliable metering
- Access to the iPad's built-in camera to personalize each channel



## 2. Master Page



### Master any situation

- Powerful 7-band graphic EQ to adjust the overall sound to the venue in seconds
- Quickly select reverb programs and adjust reverb levels for each channel
- Control master volume, balance and sub level whenever changes are required

Note: the master level fader is present in every page of the App!



# LUCAS NANO REMOTE APP FOR LUCAS NANO 608i

## 3a. Channel Page in Easy Mode

The LUCAS NANO REMOTE App for iPad lets you choose how you want to work with its sound-shaping tools. Easy Mode offers intuitive, streamlined settings for users who do not consider themselves pro mixers, while Expert Mode offers all pro sound experts myriad possibilities to optimize their live mix.



### As easy as it can get

- A simple but powerful 4-band EQ to shape the sound of each channel individually, including a low cut filter
- A powerful one-knob compressor to add power and punch to thin-sounding signals
- A Panorama knob to place the signal anywhere you want within the stereo field

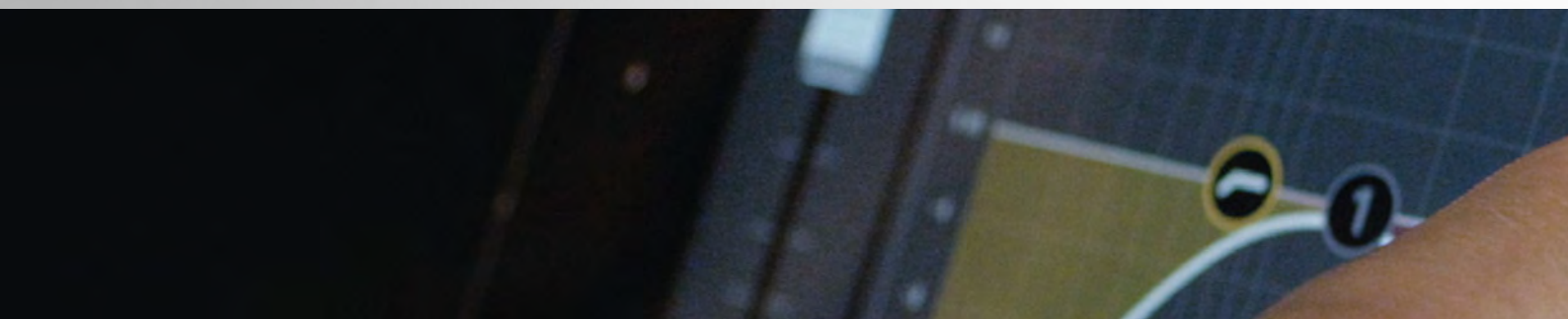

### 3b. Channel Page in Expert Mode

The Expert Mode offers all sound masters a wide range of settings to optimize their live mixes.



#### Expert parameters – instant results!

- The drawable 4-band EQ means expertly crafted sounds are just a swipe of the finger away: just touch and drag the EQ bands until the sound is 'right'!
- A variable low cut filter gets rid of unwanted low frequency rumbles
- A fully fledged, feature-rich compressor with all the parameters you need to dynamically shape your sound to perfection



# LUCAS NANO REMOTE APP FOR LUCAS NANO 608i

## 4. Presets and scenes

You can save all your settings in the LUCAS NANO REMOTE App at any time, which means you're always ready for the next show. Just open them with the touch of a button whenever you need them. Plus, you can share your favorite channel presets with your bandmates!



### Presets for each venue

Save and recall complete scenes (all channel settings plus master settings).

Create your own library of favorite channel presets for microphones and instruments.

The App comes loaded with a selection of channel presets (created by our team of HK Audio engineers) - they might be a good starting point to help you find the perfect sound.

## Connecting your iPad to the LUCAS NANO 608i

It couldn't be simpler, and there is no hassle of setting up Wi-Fi networks, because LUCAS NANO 608i and the LUCAS NANO REMOTE App communicate via Bluetooth. Just set the 608's REMOTE CONTROL switch to ON and select LUCAS NANO 608i in the iPad's Bluetooth Devices list, and you're ready for wireless mixing!

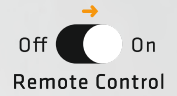

## Safe connection

Just to make sure you're always in the know about your connection strength, we've implemented a very useful tool: the NANO STATUS icon with included Bluetooth signal strength meter. This little helper always indicates the connection strength between your iPad and the LUCAS NANO 608i.

Depending on the location and setup, this could be anything from around 10 to 50 meters – more than enough for the vast majority of applications.

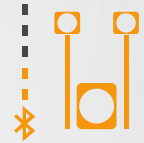

## The show must go on

It's important to stress that LUCAS NANO 608i is still a complete all-in-one PA – even without the LUCAS NANO REMOTE App for iPad. If you forget your iPad or break it during the show, or if you're playing so many encores the battery simply runs out, you still have control over all the vital LUCAS NANO 608i functions via the on-board mixer. Incidentally, all the knobs on the LUCAS NANO 608i unit itself always override the App settings. This means that whenever you twist a knob on the 608i, the corresponding knob in the App will pick up on it and will follow suit.

The LUCAS NANO REMOTE App also works offline, meaning you can explore all the extended features and plan all your settings from the comfort of your home. So download it for free at the Apple App Store now!





























	LUCAS NANO 302	LUCAS NANO 602	LUCAS NANO 305 FX	LUCAS NANO 605 FX	LUCAS NANO 608i
 Calculated peak power	750 W	1500 W	750 W	1500 W	1500 W
 Input channels	2	2	5	5	8
 System weight	10.3	16.3	10.3	16.3	16.3
 Audience size	80	120	80	120	120
 Stereo/Mono setup	✓	✓	✓	✓	✓
 S-Connect connection	✓	✓	✓	✓	✓
 Link In/Out (extendable)	✓	✓	✓	✓	✓
 Multicell Transformer	✗	✓	✗	✓	✓
 Bluetooth streaming	✗	✗	✓	✓	✓
 Integrated mixer	✗	✗	✓	✓	✓
 Phantom power	✗	✗	✓	✓	✓
 Integrated EQs	✗	✗	✓	✓	✓
 Built-in reverb effects	✗	✗	✓	✓	✓
 Remote controllable via iPad	✗	✗	✗	✗	✓
 Professional EQ control via App	✗	✗	✗	✗	✓
 Compressor via App	✗	✗	✗	✗	✓
 Master EQ via App	✗	✗	✗	✗	✓
 Scenes and presets via App	✗	✗	✗	✗	✓

# SETUP OPTIONS

## LUCAS NANO 605 FX

Stereo setup

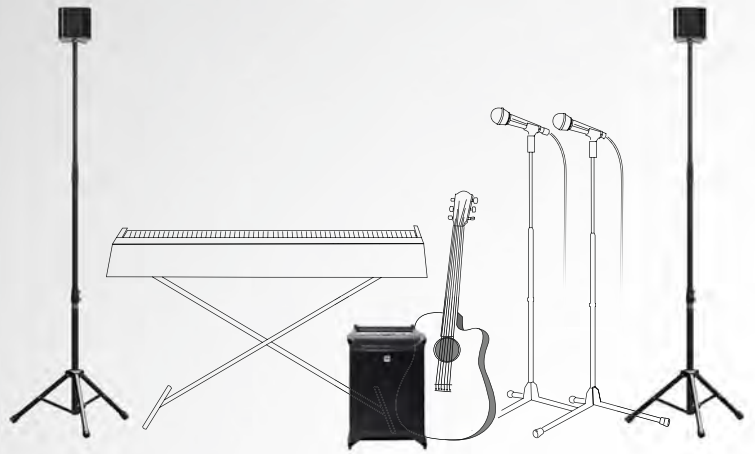
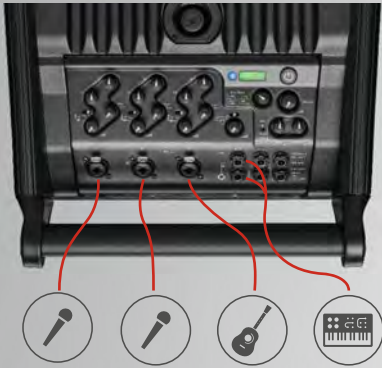

## LUCAS NANO 305 FX

Mono setup



## LUCAS NANO 608i + LUCAS NANO 602

Twin Stereo System setup

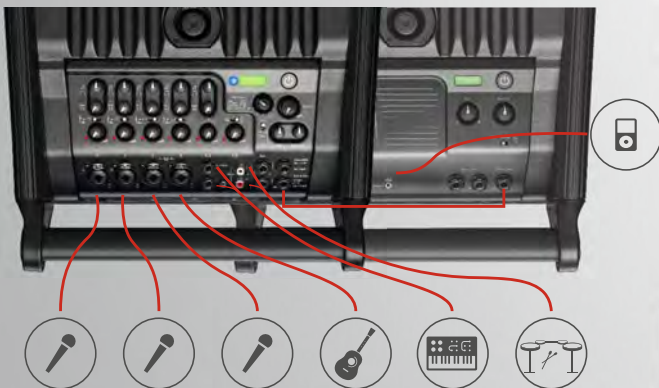

## LUCAS NANO 602

Stereo setup



## LUCAS NANO 602 + LUCAS NANO 602

Twin Stereo System setup

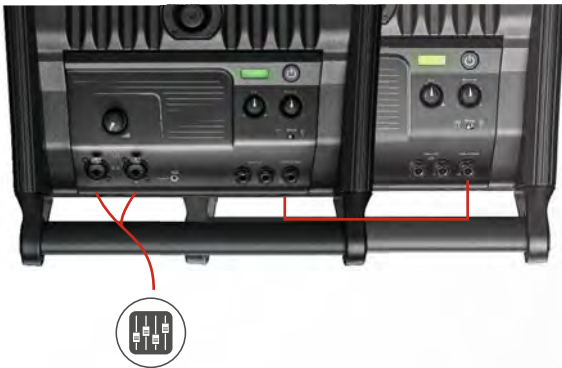

## LUCAS NANO 608i + LUCAS NANO 602

Twin Stereo System setup

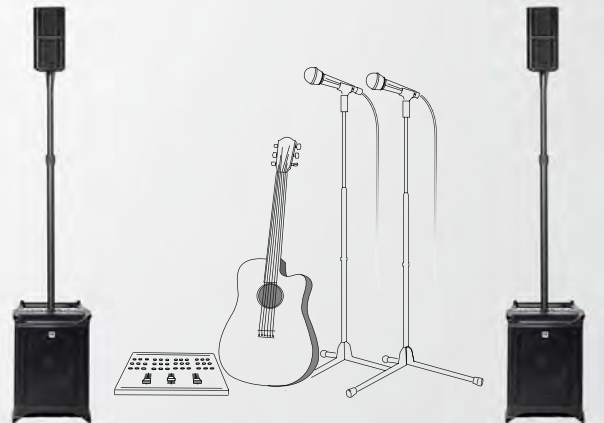

# ACCESSORIES

---



## STEREO STAND ADD-ON

This set consists of two König & Meyer adjustable tripods, two speaker cables with Neutrik® speakon connectors, and a carry bag.



## LINK CABLE

This cable with stereo ¼" (6.3 mm) Neutrik® jack plugs links two LUCAS NANO units to configure a Twin Stereo setup.



## S-CONNECT POLE LN

The ultra-lightweight, height-adjustable S-Connect Pole LN speaker extension pole provides an elegant way of mounting your LUCAS NANO satellites on to the subwoofer. Simply screw the pole into the pole mount on top of the subwoofer, snap the satellites right on to the pole, and you're good to go. Courtesy of the built-in signal bus, you don't need an external speaker cord. Setup takes just seconds – that's cordless convenience and elegant handling rolled into one.

- Length adjustable between 83 cm and 137 cm
- Anodized aluminum
- Weight: 0.9 kg



## DESK / WALL MOUNT

This set consists of two wall mounts/ tabletop tripods, two cables and two ¼" (6.3 mm) jack adapters. Satellites can be set on flat surfaces and mounted to walls with these dual-purpose holders.



## POLE MOUNT ADAPTER

Set of two pole mount adapters with Easy-Click locking mechanisms, to attach the satellites to standard 35 mm-diameter speaker poles (without signal contacts).



## DRUM RACK ADAPTER

Two rods with 3/8" threads, 25 cm long and 18 mm in diameter, that attach to rack clamps.



## ROLLER BAG

This padded trolley offers a convenient means of transportation and protects your LUCAS NANO against moisture, dirt and damage.



## LUCAS NANO REMOTE

Free App for iPad that allows you to control LUCAS NANO 608i remotely. You can control the Mixer Page, the Master Page and the Channel Page very easily and intuitively with your fingertips.



# STEREO RULES! THIS IS WHY

---

Been there, heard that: the keyboard's piano patches sound majestic over headphones. You can hear the lower register keys on the left and the high notes on the right as realistically as if you were sitting at the real thing. And that Leslie rotor sends those organ swirls spinning around your ears. What a wonderful audio experience.

Your favorite band's new song also sounds great. Each instrument has its place in the stereoscape. Those pros in the studio sure got it right: the guitars are panned left and right and the vocals take up a broad swath of sonic space in the middle. But it's a bitter disappointment when you play any of this back through a mono speaker system or smartphone.

Everything sounds thin and one-dimensional, strangely hollow, with no spatial depth. Details are lost in the ether; sometimes individual instruments and melodies are no longer audible. Why is that?

Well, simply said, it's because of mono summing... which is the summation of left and right, meaning the addition of the information in the stereo channels. Essentially, both your stereo channels are fed to your mono speaker(s). This works great, but only if the stereo signal is "mono compatible". But most of the time, it isn't. And, as a result, the quality of the sound suffers significantly.



## Stereo sound field

Every signal has its own dedicated position in the stereo field between the left and right speakers.

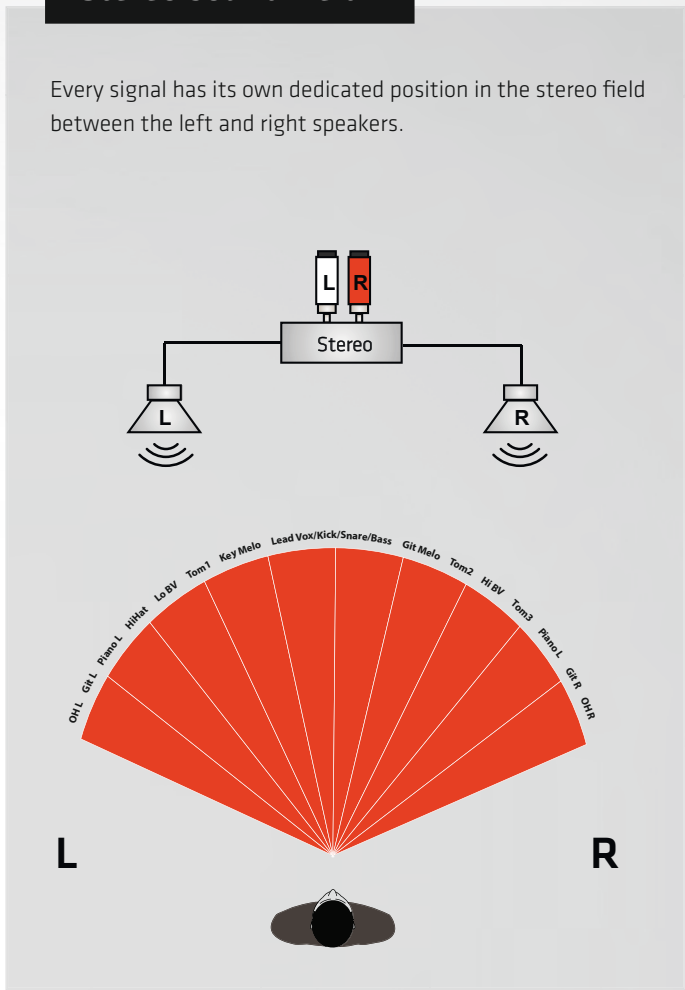

## Mono summing

The left and right channels are summed together. All signals outside the centerfield are significantly thinned out, or disappear altogether.

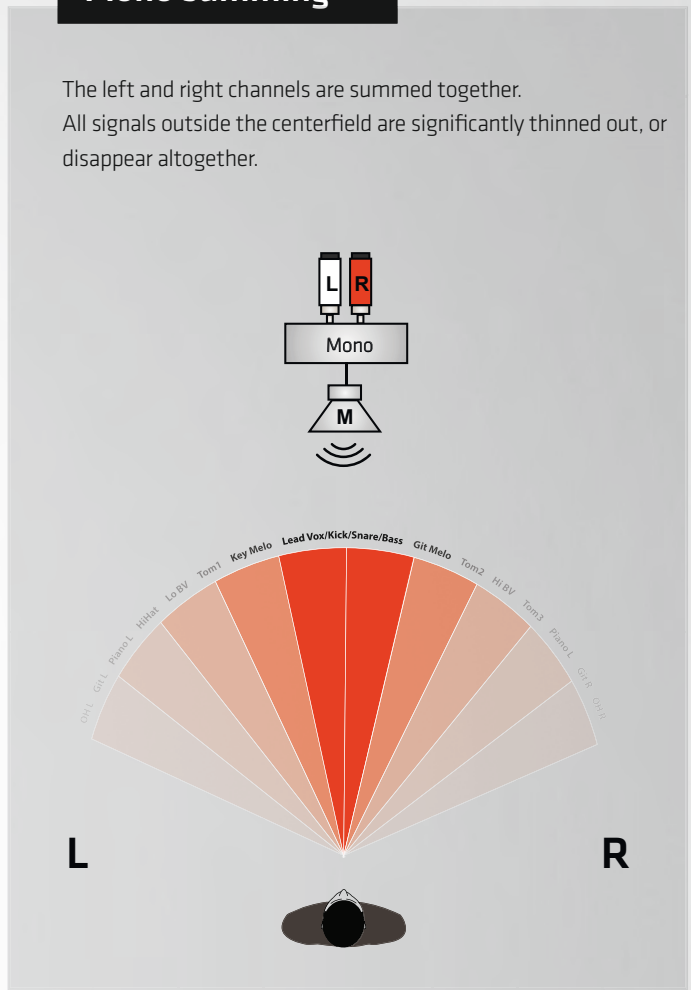

Stereo signals get “lossy” when piped through a mono channel. Stereo mixes of music and instruments sound flat and drab, while left/right panning and spatial effects are lost.

Of course, mono setups have their uses: for example, for public address or a singer-songwriter performing with mono mic and mono guitar signals. But stereo signals should always be reproduced in stereo, for the good of your audio!

**So, if you use or enjoy the following audio signals, we recommend you use a stereo sound system...**



CDs, MP3s, etc.



Keyboards



Live music



Multimedia



Stereo effects

For more information, search for the Hashtag **#LIFEISSTEREO**

# ABOUT HK AUDIO

---

## The HK Audio Team at our HQ in St. Wendel, Germany

What drives us? Our passion for music. What motivates us? Our fascination for sound.

All our business departments – from our development engineers and production workers to our sales, marketing and customer service teams – have one mission in common: we are all making a contribution to make the world sound better.





## Our story

Over the course of the past thirty years, the name HK Audio has become synonymous in Europe with live sound reinforcement systems of the highest quality. Made in Germany, these systems are the product of a lifelong passion and pursuit of a vision – the aspiration to deliver perfect sound.

Today, the systems we manufacture in our world-class facilities in St. Wendel, Germany, serve an extremely broad range of applications. Thanks to the efforts of our highly skilled and dedicated team of more than 200 people, HK Audio has firmly established itself as one of the most distinguished names in professional sound reinforcement in Europe.

HK Audio has many innovations to its credit in touring, arena and open-air PA systems for concerts with 50,000+ audiences. We also invented the 2.1 system featuring active electronics built into a subwoofer to drive two passive satellites. In 1998, we called this milestone in audio engineering the Lightweight Ultra Compact Active System, or LUCAS, for short. Well over 100,000 LUCAS systems have since been deployed around the world, serving users for a huge range of audio applications.

The NANO series picks up where the LUCAS philosophy left off, packing impressive PA sound into an extremely portable, lightweight format. Who would have thought that carting and setting up a PA could actually be fun?

But what's even more fun is the incredible sound: these handy systems throw powerful bass and crystal-clear high frequencies all the way to the back row. And they deliver the sonic goods at levels of sound quality and volume that defy everyone's expectations for a system of this size.



# LUCAS NANO USERS ARE A VERY HAPPY BUNCH!

---

**93.5 %\*** of LUCAS NANO users would recommend HK Audio to their friends!



**89.8 %** of LUCAS NANO users would definitely buy another HK Audio product!



**86.2 %** of LUCAS NANO users are pleased with the price-performance ratio offered by HK Audio products!



**95.8 %** of LUCAS NANO users are pleased with the quality of HK Audio products!



\* These figures were obtained through a representative survey of HK Audio users, carried out in spring 2017.

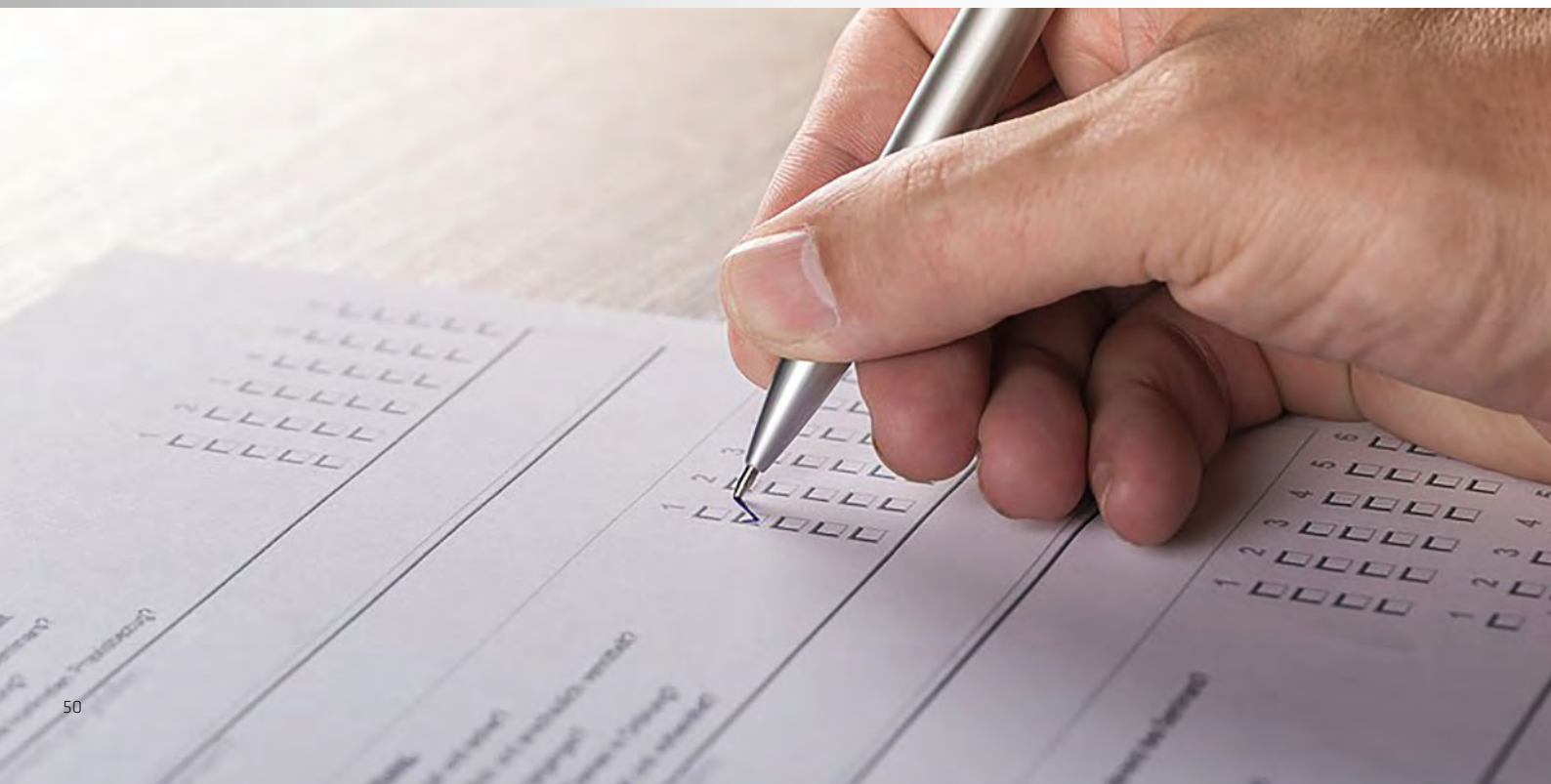

# TECHNICAL DATA

LUCAS NANO system	300 series	600 series
Power	750 W (calc. peak) 1500 W (calc. peak) (Twin Stereo System)	1500 W (calc. peak) 3000 W (calc. peak) (Twin Stereo System)
Total power output	230 W RMS* 460 W RMS* (Twin Stereo System)	460 W RMS* 920 W RMS* (Twin Stereo System)
Max SPL peak**	120 dB (Satellite Array) 126 dB (Twin Stereo System)	130 dB (Satellite Array) 136 dB (Twin Stereo System)
Frequency response	44 Hz-20 kHz (- 10dB)	43 Hz-20 kHz (+/- 3 dB)
Inputs	Choice of two different input panels	Choice of three different input panels
Outputs	Speaker Out (6.35 mm jack), Easy-Click, Thru, Link Out (for Twin Stereo mode)	Speaker Out (Speakon), Easy-Click, Thru, Link Out (for Twin Stereo mode)
Active protective circuits	MultiBand Limiter, Subsonic Filter, Thermo Protection, Overload Protection	MultiBand Limiter, Subsonic Filter, Thermo Protection, Overload Protection
Enclosure	Coated polypropylene	Coated polypropylene
Dimensions (W x H x D)	30 x 39 x 42 cm	35 x 49 x 47 cm
Weight	10.3 kg / 22.7 lbs. 20.6 kg / 45.4 lbs. (Twin Stereo System)	16.3 kg / 36 lbs. 32.6 kg / 72 lbs. (Twin Stereo System)
Satellite	300 series	600 series
Mid/High Speaker	3.5" (Celestion custom-made)	4.5" + 1", coaxial (Celestion custom-made)
HF Horn type	HK Audio HF Diffraction Lens	HK Audio Multicell Transformer
Directivity horizontal/vertical	60° x 40° (Single Satellite) 60° x 30° (Satellite Array)	90° x +10/-45° (Single Satellite) 90° x 30° (Satellite Array)
Pole mount	3/8" thread	3/8" thread
Dimensions (W x H x D)	13 x 13 x 11.5 cm	14.5 x 14.5 x 13.5 cm
Weight	1 kg / 2.2 lbs.	1.2 kg / 2.6 lbs.
Subwoofer	300 series	600 series
LF Speaker	8" (Celestion custom-made)	10" (Celestion custom-made)
Pole mount	M33 for S-Connect Pole LN, M20 via speaker pole adapter sleeve (included)	M33 for S-Connect Pole LN, M20 via speaker pole adapter sleeve (included)

\* Short-term RMS value measured using a sine burst signal with a 1/4 cycle rate and a resulting crest factor of 9 dB at a frequency that is representative of the system

\*\* @10% THD, Halfspace



*THE SOUNDMAKERS*

HK Audio  
Postfach 1509  
66595 St. Wendel, Germany

[info@hkaudio.com](mailto:info@hkaudio.com)  
[www.hkaudio.com](http://www.hkaudio.com)

© 2018 Music & Sales P.E. GmbH  
Subject to change without notice  
MS D-2990, 9880864