



Electro-Voice

PRO SOUND

Loudspeakers and Electronics

2015

A

At Electro-Voice, we Live for Sound. For more than 85 years, we have designed and engineered leading-edge sound reinforcement solutions that empower the performer, exceed the expectations of the audio professional and elevate the audience experience.

CONTENTS

X-Line Advance	4
X-Line	6
XLC	8
XLCi	9
XLVC	10
Xi Series	12
EVF Front-Loaded Systems	14
EVF Front-Loaded Subwoofers	18
EVH Horn-Loaded Systems	20
EVA Expandable Vertical Array	22
EVA Subwoofers	23
EVU Ultracompact Systems	24
EVI Variable Intensity Loudspeakers Systems	26
EVID Surface-Mount Systems	28
EVID In-Wall Speaker Systems	29
EVID Ceiling Speaker Systems	30
EVID Compact Sound speaker series	32
Specialty Loudspeakers	34
Monitors	35
EVM12L Guitar Speakers	36
ZX/ZXA	37
SX	40
QRx	42
Tour X	44
ETX Powered Loudspeakers	46
EKX	48
Live X	50
ZLX	52
Rigging and Accessories	54
Tour Grade Amplifiers	64
Q Series Amplifiers	66
CPS Contractor Precision Series Amplifiers	68
CP Compact Precision Amplifiers	71
PA Series Commercial Power Amplifiers	72
Netmax	74
Sound System Processors	76



X-Line Advance

A driving force in concert sound reinforcement since its beginning, EV is dedicated to developing products that exceed the ever-higher expectations of audiences, performers, and production professionals the world over. We channel our industry-leading engineering experience and R&D resources towards product designs that push the art and science of sound forward, rather than following the pack.

To achieve our goal of creating a line array with the best acoustic and mechanical performance, we talked to dozens of touring professionals and combined their real-world insight with our decades of line-array know-how.

The result is the next generation of our legendary X-Line family, offering breakthrough new components that work together to surpass the performance of other leading line arrays, and all in a more compact, flexible, and faster-to-set-up package.

X1-212/90



- EV-exclusive Mid-Band Hydra device that effectively emulates the acoustic behavior of a double line of four 3" point sources to deliver superior mid-band coupling of the array while maintaining the efficiency, power, and bandwidth of a 12" transducer.
- Revolutionary HF section in the X1 incorporates two new ND2R ring-exit high-output 2" titanium compression drivers coupled to a pair of WCH constant energy planar wave generators on a 90° waveguide optimized for high efficiency, uniform pattern control, and smooth, extended, linear response.
- Twist-lock multi-angle arraying system designed by EV to simplify the rigging of any size of array, significantly reducing load in/out time and production costs.

X2-212/90



- High-sensitivity DVN3125 woofer was developed using Finite Element Analysis to optimize motor, suspension, and electrical design for very low distortion, high efficiency, and maximum intelligibility at high SPL.
- EV-exclusive Mid-Band Hydra device that effectively emulates the acoustic behavior of a double line of four 3" point sources to deliver superior mid-band coupling of the array while maintaining the efficiency, power, and bandwidth of a 12" transducer.
- Two ND6A high-output 3" titanium compression drivers to the pair of Advanced PDH Pin Diffraction Hydra constant energy planar wave generators on a 90° waveguide. The Advanced PDH Pin Diffraction Hydra provides full control of the acoustic wave, eliminating wave distortion with in-phase summation to 20 kHz.
- Only sold in systems with EV amplification and FIR-Drive processing.

X12-128



- High-output, high-impact dual 18" subwoofer system
- Super-high-output DVF4180 woofers for low distortion at extremely high SPLs
- Dual front and rear signal connection points for flexibility in system configurations, including cardioid setup for increased focus of low-frequency output
- Compact cabinets with low-profile footprint, suitable for under-stage applications
- 105 dB sensitivity (1 W/1 m half space)
- Power handling: 4000 W continuous, 16,000 W peak
- 141/147 dB maximum SPL (continuous/peak)



See page 56–57 for X-Line Advance Rigging and Accessories.

	X1-212/90	X2-212/90	X12-128
Frequency Response (-3 dB)	57 Hz – 16 kHz	52 Hz – 19 kHz	33 Hz – 200 kHz
Horizontal Coverage	90° horizontal	90° horizontal	Omni directional
System Sensitivity	98 dB (1 W/1 m)	101 dB (1 W/1 m)	105 dB (1 W/1 m)
LF Transducer	12" SMX2121	12" DVN3125	2 x 18" DVF4180
HF Transducer	Two 2" ND2R	Two 3" ND6A	N/A
Configuration	Passive, Biamp	Biamp only	Passive, Biamp
Enclosure Material	EVCoat-coated birch plywood	EVCoat-coated birch plywood	EVCoat-coated birch plywood
Dimensions (H x W x D)	13.5" x 28.5" x 21.1" (34.29 cm x 72.39 cm x 53.66 cm)	13.5" x 28.5" x 21.1" (34.29 cm x 72.39 cm x 53.66 cm)	20.4" x 43.5" x 29.9" (51.75 cm x 110.49 cm x 75.88 cm)
Net Weight	92 lbs (41.73 kg)	93 lbs (42.18 kg)	195 lbs (88.45 kg)



X-Line is a concert sound loudspeaker system that combines high-level sonic impact and vocal intelligibility with the uniform, predictable coverage that only a line array can deliver. The X-Line system provides wide horizontal dispersion from a single vertical line array with exceptionally coherent wave-front summation in the vertical plane. Extended low-frequency polar control produces more uniform power response, further enhancing overall intelligibility.

The two full-range boxes in the line are three-way systems that incorporate the Electro-Voice Hydra time-synchronized, high-frequency plane wave generator to provide excellent summing in the far field. They also employ Ring-Mode Decoupling (RMD) to provide level-independent fidelity, greater mid-bass clarity and high-frequency accuracy. All models in the line share the same footprint and are connected by proprietary rigging that facilitates rapid venue load-in and load-out.

Xvls THREE-WAY LONG-THROW ELEMENT



- High-output, three-way line array system
- Rectangular cabinet design
- 90° horizontal coverage pattern ideal for long-throw applications
- EV Hydra time-synchronized vertical plane-wave generator provides excellent far-field summing
- Ring-Mode Decoupling (RMD) provides level-independent fidelity, greater mid-bass clarity and high-frequency accuracy
- Proprietary rigging allows for rapid venue load-in and load-out

Xvlt THREE-WAY MEDIUM-THROW ELEMENT



- High-output, three-way line array system
- Five-degree trapezoidal cabinet design for lower "J" section of linear array
- 120° coverage typical for medium-throw assignment
- EV Hydra time-synchronized vertical plane-wave generator provides excellent far-field summing
- Ring-Mode Decoupling (RMD) provides level-independent fidelity, greater mid-bass clarity and high-frequency accuracy
- Proprietary rigging allows for rapid venue load-in and load-out

Xsub(F) DUAL 18" SUBWOOFER ELEMENT



- High-output, line array subwoofer system
- Rectangular cabinet with footprint identical to other X-Line systems
- Can be flown or ground-stacked. Also available in non-flying version
- Proprietary rigging allows for rapid venue load-in and load-out

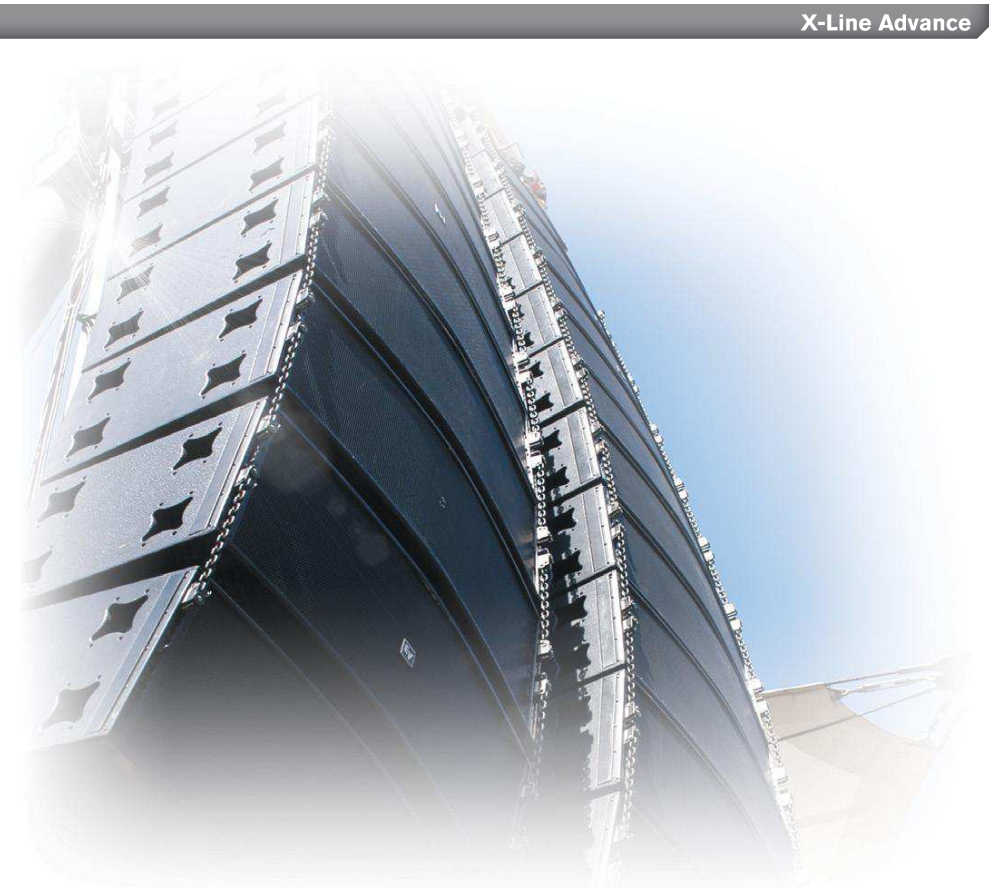

	Xvls	Xvlt	Xsub(F)
Frequency Response (-3 dB)	50 Hz – 16 kHz	50 Hz – 16 kHz	40–400 Hz
Frequency Range (-10 dB)	30 Hz – 17 kHz	30 Hz – 17 kHz	35–500 Hz
Horizontal Coverage	90°	120°	
Vertical Coverage*	5°	8°	
LF Power Handling ¹	1200 W continuous, 4800 W peak	1200 W continuous, 4800 W peak	1200 W continuous, 4800 W peak ⁴
MB Power Handling ²	600 W continuous, 2400 W peak	600 W continuous, 2400 W peak	
HF Power Handling ³	225 W continuous, 900 W peak	225 W continuous, 900 W peak	
Sensitivity ¹ LF/MB/HF	98/108/114 dB	97/107/114 dB	104 dB (half space)
Max. SPL* (calc, peak) LF/MB/HF	134/142/144 dB	133/141/144 dB	141 dB (half space)
Peak SPL @ 10m**	135 dB	135 dB	132 dB (half space)
LF Transducer	Two 15" EVX-155PL	Two 15" EVX-155PL	Two 18" EVX-180B
MB Transducer	Two 8" ND08	Two 8" ND08	
HF Transducer	Three 3" ND6-16	Three 3" ND6-16	
Connectors	2 Neutrik NL8	2 Neutrik NL8	2 Neutrik NL8
Enclosure Material	Birch plywood, textured epoxy paint	Birch plywood, textured epoxy paint	Birch plywood, textured epoxy paint
Grille	Powder-coated steel	Powder-coated steel	Powder-coated steel
Environmental Specs	IEC 529 IP24, MIL STD 810	IEC 529 IP24, MIL STD 810	IEC 529 IP24, MIL STD 810
Dimensions (H (front/rear) x W x D) [†]	19.46"/19.46" x 49" x 29.15" (494.3/494.3 x 1244.6 x 740.4 mm)	19.46"/16.92" x 49" x 29.15" (494.3/429.7 x 1244.6 x 740.4 mm)	19.46"/19.46" x 49" x 29.15" (494.3/494.3 x 1244.6 x 740.4 mm)
Net Weight [†]	257 lb (117 kg)	253 lb (115 kg)	202 lb (92 kg)

*Single Box @ 1 Meter
 **4 Box Array @ 10 Meters
¹50-200 Hz
²300-2000 Hz
³1200-8000 Hz
⁴50-100 Hz



XLC

Whether at a medium-sized festival, in a large concert hall or house of worship, or as a supplementary system used with X-Line, XLC compact line arrays have a proven record of performance and reliability. It's no wonder that XLC is

one of the most popular line array systems in the world. All modules incorporate Quik-Rig hardware for fast set-up and tear-down.

XLC127DVX XLC907DVX

120° HORIZONTAL THREE-WAY COMPACT LINE ARRAY ELEMENT
90° HORIZONTAL THREE-WAY COMPACT LINE ARRAY ELEMENT



- Accurate vertical control and coverage
- Compact, lightweight modules
- True three-way design
- Triamp operation; biamp operation with optional mid-high crossover (XLC127DVX only)
- Quik-Rig fast and simple integrated rigging
- Supported by LAPS II array design/prediction software

XLC215

HIGH-OUTPUT DUAL 15" SUBWOOFER LINE ARRAY ELEMENT



- 138 dB SPL
- Footprint identical to XLC127DVX
- Optional adapter grid for use with XLD281 and XLD291
- Two DVX3150A transducers
- Quik-Rig fast and simple integrated rigging

See page 54–55 for XLC Rigging and Accessories.

	XLC127DVX	XLC907DVX	XLC215
Frequency Response (-3 dB)	65 Hz – 16 kHz	65 Hz – 16 kHz	40–400 Hz
Frequency Range (-10 dB)	54 Hz – 17 kHz	54 Hz – 17 kHz	30–400 Hz
Horizontal Coverage	120°	90°	
LF Power Handling ¹	500 W continuous, 2000 W peak	500 W continuous, 2000 W peak	1000 W continuous, 4000 W peak ⁴
MB Power Handling ²	300 W continuous, 1200 W peak	300 W continuous, 1200 W peak	
HF Power Handling ³	150 W continuous, 600 W peak	150 W continuous, 600 W peak	
Sensitivity* LF/MB/HF	95/101/111 dB	95/101/112 dB	102 dB
Max. SPL* (calc., peak), LF/MB/HF	128/132/139 dB	128/132/140 dB	138 dB
Peak SPL @ 10m**	130 dB	130 dB	124 dB
LF Transducer	12" DVX3121A	12" DVX3121A	Two 15" DVX3150A
MB Transducer	Two 6.5" DVN2065	Two 6.5" DVN2065	
HF Transducer	Two 3" ND6-16	Two 3" ND6-16	
Connectors	2 Neutrik NL8	2 Neutrik NL8	2 Neutrik NL8
Enclosure Material	EVCoat-coated birch plywood	EVCoat-coated birch plywood	EVCoat-coated birch plywood
Grille	Powder-coated steel	Powder-coated steel	Powder-coated steel
Environmental Specs	IEC 529 IP24, MIL STD 810	IEC 529 IP24, MIL STD 810	IEC 529 IP24, MIL STD 810
Dimensions (H x W x D)*	14.25" x 39" x 22.5" (362 x 991 x 572 mm)	14.25" x 39" x 22.5" (362 x 991 x 572 mm)	21.5" x 39" x 22.5" (546 x 991 x 572 mm)
Net Weight*	111 lb (50.4 kg)	111 lb (50.4 kg)	129 lb (58.5 kg)

*Single Box @ 1 Meter
**4 Box Array @ 10 Meters

¹ 100-500 Hz

² 500-2000 Hz

³ 1600-8000 Hz

⁴ 60-100 Hz



XLCi

XLCi is a version of the XLC line that has been adapted for permanent installations. XLCi features visually appealing rigging that won't distract from architectural aesthetics. The performance of the three modules in the line is identical

to that of the corresponding model in the XLC line. XLCi loudspeakers are supported by LAPS II array design/prediction software.

XLCi127DVX XLCi907DVX

120° HORIZONTAL THREE-WAY COMPACT LINE ARRAY ELEMENT
90° HORIZONTAL THREE-WAY COMPACT LINE ARRAY ELEMENT



- Accurate vertical control and coverage
- Compact, lightweight modules
- True three-way design
- Triamp operation; biamp operation with optional mid-high crossover (XLCi127DVX only)
- Fixed installation rigging
- Supported by LAPS II array design/prediction software

XLCi215

HIGH-OUTPUT DUAL 15" SUBWOOFER ELEMENT



- Footprint identical to other XLCi models
- Two DVX3150A transducers
- Compact and lightweight
- Fixed installation rigging

See page 54–55 for XLCi Rigging and Accessories.

	XLCi127DVX	XLCi907DVX	XLCi215
Frequency Response (-3 dB)	65 Hz – 16 kHz	65 Hz – 16 kHz	40–400 Hz
Frequency Range (-10 dB)	54 Hz – 17 kHz	54 Hz – 17 kHz	30–400 Hz
Horizontal Coverage	120°	90°	300°
LF Power Handling ¹	500 W continuous, 2000 W peak	500 W continuous, 2000 W peak	1000 W continuous, 4000 W peak ⁴
MB Power Handling ²	300 W continuous, 1200 W peak	300 W continuous, 1200 W peak	
HF Power Handling ³	150 W continuous, 600 W peak	150 W continuous, 600 W peak	
Sensitivity* LF/MB/HF	95/101/111 dB	95/101/112 dB	102 dB
Max. SPL* (calc., peak), LF/MB/HF	128/132/139 dB	128/132/140 dB	138 dB
Peak SPL @ 10m**	130 dB	130 dB	124 dB
LF Transducer	12" DVX3121A	12" DVX3121A	Two 15" DVX3150A
MB Transducer	Two 6.5" DVN2065	Two 6.5" DVN2065	
HF Transducer	Two 3" ND6-16	Two 3" ND6-16	
Connectors	2 Neutrik NL8	2 Neutrik NL8	2 Neutrik NL8
Enclosure Material	EVCoat-coated birch plywood	EVCoat-coated birch plywood	EVCoat-coated birch plywood
Grille	Powder-coated steel	Powder-coated steel	Powder-coated steel
Environmental Specs	IEC 529 IP24, MIL STD 810	IEC 529 IP24, MIL STD 810	IEC 529 IP24, MIL STD 810
Dimensions (H x W x D)*	14.25" x 36.5" x 22.5" (362 x 927 x 572 mm)	14.25" x 36.5" x 22.5" (362 x 927 x 572 mm)	21.5" x 36.5" x 22.5" (546 x 927 x 572 mm)
Net Weight*	105 lb (48.1 kg)	105 lb (48.1 kg)	124 lb (56.3 kg)

*Single Box @ 1 Meter
**4 Box Array @ 10 Meters

¹ 100-500 Hz

² 500-2000 Hz

³ 1600-8000 Hz

⁴ 60-100 Hz



When a line array with limited size and weight is required, XLVC is the choice of professionals around the world. XLVC Very Compact Line Arrays combine reliability, intelligibility and acoustic performance in a package that is easy to

configure and suspend. All cabinets feature simple, quick, integrated rigging. System design is easy using Electro-Voice's free LAPS II array design/prediction software.

XLD281 120° HORIZONTAL THREE-WAY DUAL 8" LINE ARRAY ELEMENT



- Full-bandwidth, three-way element (60 Hz – 20 kHz)
- CCT (Coverage Control Technology)
- Versatile subwoofer integration
- Biamp or triamp operation
- Neodymium transducers
- Simple, quick, integrated rigging
- Supported by LAPS II array design/prediction software

XLD291 90° HORIZONTAL THREE-WAY DUAL 8" LINE ARRAY ELEMENT



- Full-bandwidth, three-way element
- CCT maintains 90° horizontal coverage to 250 Hz
- Versatile subwoofer integration
- Biamp or triamp operation
- Neodymium transducers
- Simple, quick, integrated rigging
- Supported by LAPS II array design/prediction software

XLE181 120° HORIZONTAL TWO-WAY SINGLE 8" LINE ARRAY ELEMENT
XLE191 90° HORIZONTAL TWO-WAY SINGLE 8" LINE ARRAY ELEMENT



- Full-bandwidth, two-way element
- Most compact, very lightweight
- Biamp or full-range operation
- Neodymium transducers
- Simple, quick, integrated rigging
- Supported by LAPS II array design/prediction software

XCS312 TRIPLE 12" CARDIOID BASS ELEMENT



- Versatile integration in main arrays
- Self-contained rigging hardware
- Supported by LAPS II array design/prediction software

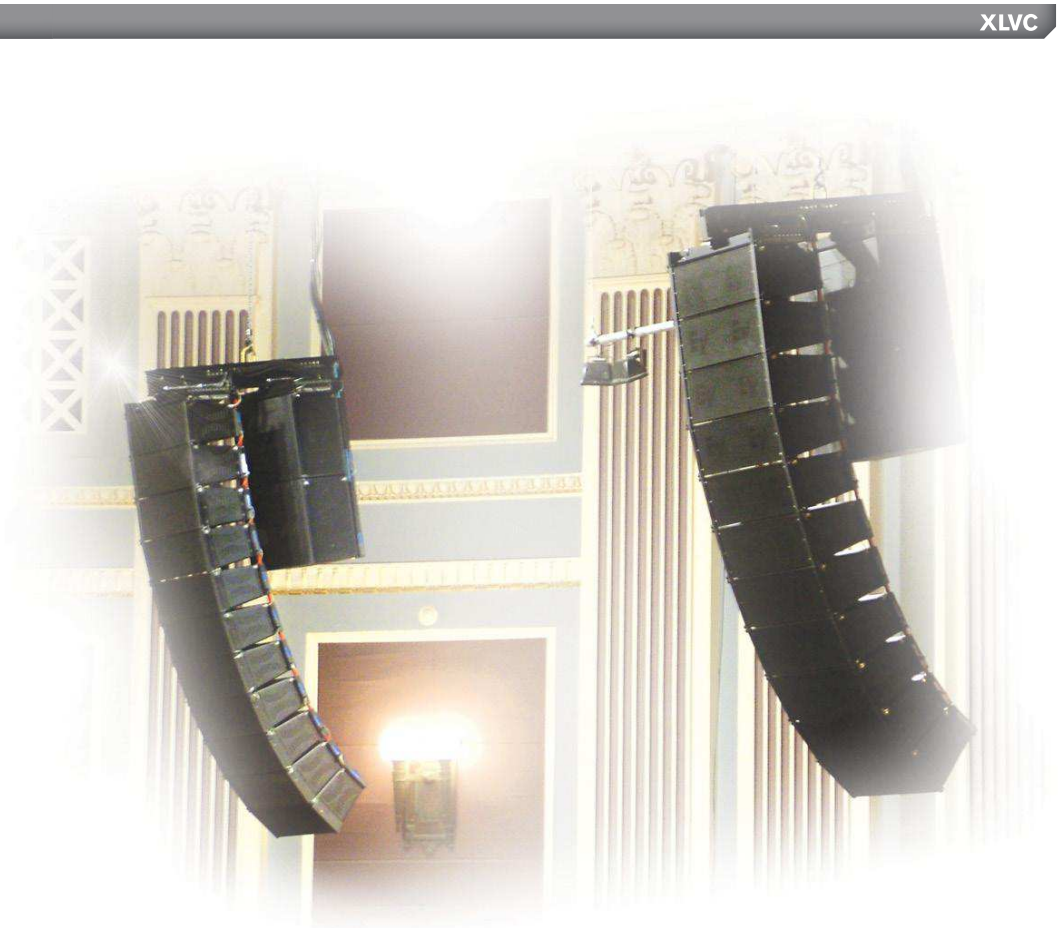

	XLD281	XLD291	XLE181	XLE191	XCS312
Frequency Response (-3 dB)	65 Hz – 16 kHz	65 Hz – 16.2 kHz	65 Hz – 16 kHz	65 Hz – 16.2 kHz	45–100 Hz
Frequency Range (-10 dB)	56 Hz – 16.5 kHz	56 Hz – 16.7 kHz	56 Hz – 16.5 kHz	56 Hz – 16.7 kHz	40–100 Hz
Horizontal Coverage	120°	90°	120°	90°	200°
LF1 Power Handling ¹	200 W continuous, 800 W peak	200 W continuous, 800 W peak	200 W continuous, 800 W peak	200 W continuous, 800 W peak	1000 W continuous, 4000 W peak ⁴
LF2 Power Handling ²	200 W continuous, 800 W peak	200 W continuous, 800 W peak			500 W continuous, 2000 W peak ⁴
HF Power Handling ³	80 W continuous, 320 W peak	80 W continuous, 320 W peak	80 W continuous, 320 W peak	80 W continuous, 320 W peak	
Sensitivity* LF-MB/HF	99/112 dB	99/113 dB	99/112 dB	99/113 dB	100 dB (half space)
Max. SPL* (calc. peak), LF-MB/HF	128/137 dB	128/138 dB	128/137 dB	128/138 dB	136 dB (half space)
Peak SPL @ 10m**	129 dB	130 dB	129 dB	130 dB	121 dB
LF Transducer	8" DVN2080	8" DVN2080	8" DVN2080	8" DVN2080	Three 12" DVX3120A
LF-MB Transducer	8" DVN2080	8" DVN2080			
HF Transducer	Two 2" ND2S	Two 2" ND2S	Two 2" ND2S	Two 2" ND2S	
Connectors	2 Neutrik NL8	2 Neutrik NL8	2 Neutrik NL8	2 Neutrik NL8	2 Neutrik NL8
Enclosure Material	EVCoat-coated birch plywood	EVCoat-coated birch plywood	EVCoat-coated birch plywood	EVCoat-coated birch plywood	EVCoat-coated birch plywood
Grille	Powder-coated steel	Powder-coated steel	Powder-coated steel	Powder-coated steel	Powder-coated steel
Environmental Specs	IEC 529 IP24, MIL STD 810	IEC 529 IP24, MIL STD 810	IEC 529 IP24, MIL STD 810	IEC 529 IP24, MIL STD 810	IEC 529 IP24, MIL STD 810
Dimensions (H x W x D)	9.9" x 28.58" x 14.52" (251 x 726 x 369 mm)	9.9" x 28.58" x 14.52" (251 x 726 x 369 mm)	9.9" x 20.3" x 14.52" (251 x 516 x 369 mm)	9.9" x 20.3" x 14.52" (251 x 516 x 369 mm)	20" x 28.58" x 26.65" (508 x 726 x 677 mm)
Net Weight	48 lb (21.8 kg)	48 lb (21.8 kg)	38 lb (17.24 kg)	38 lb (17.24 kg)	148 lb (67.13 kg)

*Single Box @ 1 Meter
**4 Box Array @ 10 Meters
¹ 750-1750 Hz
² 100-750 Hz
³ 1500-6500 Hz
⁴ 60-100 Hz

See page 54–55 for XLVC Rigging and Accessories.



Xi Series

The Electro-Voice Xi Series offers a potent combination of high output and ultra-linear performance in two-way systems. Xi Series loudspeakers incorporate the acoustic advantages of Ring-Mode Decoupling (RMD) and feature HP Constant Directivity waveguides to secure excellent directivity control and even coverage. To achieve sound performance without compromise, the Xi Series is designed for active operation, with the exception of the

Xi-1082, which contains a passive crossover network. Xi loudspeaker cabinets are made of 18 mm, 13-ply birch plywood finished in a black EVCoat and protected by a full-face, steel front grille that is backed with foam. All systems except the Xi-1082 have integrated handles and two L-tracks on the top and bottom. A detailed flying manual is available.



Xi-1082 8" TWO-WAY FULL-RANGE LOUDSPEAKER



- Ultra-compact, low profile
- Wide-range reproduction, maximized intelligibility
- Optimal under-balcony enclosure angles
- Suited for front-of-stage and near-field use
- Trapezoidal enclosure, vented for extended LF
- 1.25" DH3/2010A titanium-diaphragm HF driver
- Two 3/8" mounting bracket inserts
- Compatible with OmniMount Series 100
- EVCoat finish
- Available in black or white
- Mounting bracket available separately

Xi-1122A/85F 12" TWO-WAY FULL-RANGE LOUDSPEAKER



- Ultra-compact, high output
- Professional touring or installation
- Maximum intelligibility for voice
- 3" ND6-16 neodymium HF driver
- Trapezoidal (15°/side) 13-ply birch enclosure
- Built-in L-Track rigging
- 35 mm stand mount
- Integrated handles
- Available in black or white

Xi-1152A/64F Xi-1152A/94F 15" TWO-WAY FULL-RANGE LOUDSPEAKERS



- High-SPL in limited-space applications
- Maximum intelligibility for voice
- EVX155 woofer with 4" voice coil and Ring-Mode Decoupling (RMD)
- 3" ND6-16 neodymium HF driver
- Rotatable 60° x 40° (64F) or 90° x 40° (94F) coverage
- Solid bass down to 50 Hz (-3 dB)
- Trapezoidal (15°/side) 13-ply birch enclosure
- Built-in L-Track rigging
- 35 mm stand mount
- Integrated handles
- Available in black or white

See page 55 for Xi-1082 Rigging and Accessories.

	Xi-1082	Xi-1122A/85F	Xi-1152A/64F	Xi-1152A/94F
Frequency Response (-3 dB)	50 Hz – 20 kHz (-10 dB)	58 Hz – 17 kHz	50 Hz – 16 kHz	50 Hz – 16 kHz
Recommended High-Pass Frequency	60–80 Hz (12 dB/octave)	Dx46 preset	Dx46 preset	Dx46 preset
Axial Sensitivity (SPL, 1 W @ 1 m)	90 dB (LF/HF)	99/110 dB (LF/HF)	98/113 dB (LF/HF)	98/112 dB (LF/HF)
Max. SPL @ 1 m (calc), full space	118 dB (LF/HF)	130/135 dB (LF/HF)	132/138 dB (LF/HF)	132/137 dB (LF/HF)
Long-Term Power Handling	175 W (LF/HF)	300/75 W (LF/HF)	600/75 W (LF/HF)	600/75 W (LF/HF)
Short-Term Power Handling (peak)	700 W (LF/HF)	1200/300 W (LF/HF)	2400/300 W (LF/HF)	2400/300 W (LF/HF)
Coverage (nominal -6 dB) H° x V°	90° x 40° (Const. Dir. waveguide)	80° x 55° (Const. Dir. waveguide)	60° x 40° (Const. Dir. waveguide)	90° x 40° (Const. Dir. waveguide)
Directivity Index	11.2 dB (+1.8/-2.7 dB) 2–20 kHz	10.9 dB (+1.2/-2.9 dB) 1.2–16 kHz	13.4 dB (+1.3/-2.3 dB) 1.2–16 kHz	12.3 dB (+0.7/-1.5 dB) 1.2–16 kHz
LF woofer (transducer)	8"	12" DL-type	15" EVX155	15" EVX155
MB woofer (transducer)				
HF driver (transducer)	1.25" DH3/2010A	3" ND6-16	3" ND6-16	3" ND6-16
Crossover Frequencies	3,500 Hz (passive)	Dx46 preset	Dx46 preset	Dx46 preset
Nominal Impedance	8 Ω (LF/HF)	8 Ω/16 Ω (LF/HF)	8 Ω/16 Ω (LF/HF)	8 Ω/16 Ω (LF/HF)
Minimum Impedance	5.8 Ω (LF/HF)	8.5 Ω/13.4 Ω (LF/HF)	6.3 Ω/12.2 Ω (LF/HF)	6.3 Ω/12.2 Ω (LF/HF)
Input Connections	Barrier strip	2 four-pin Speakon	2 four-pin Speakon	2 four-pin Speakon
Dimensions (H x W at front x D)	9.25" x 11.21" x 11.22" (235 x 488 x 285 mm)	22.99" x 14.76" x 14.01" (584 x 375 x 356 mm)	29.88" x 17.72" x 16.26" (759 x 450 x 413 mm)	29.88" x 17.72" x 16.26" (759 x 450 x 413 mm)
Net Weight	29.3 lb (13.3 kg)	69 lb (31.3 kg)	89.9 lb (40.8 kg)	89.9 lb (40.8 kg)



EVF is the most comprehensive standard line of front-loaded loudspeaker systems ever offered for installed sound. Available in 12" or 15" two-way configurations and enhanced with dedicated low-frequency systems, EVF loudspeakers match exceptional audio performance, efficiency, ease-of-use and aesthetics with unprecedented value. EVF systems incorporate the latest Electro-Voice components to ensure years of reliability and exceptional sound. "S" designated systems are equipped with SMX series symmetric drive woofers and ND2B 2" titanium compression drivers; upgraded "D" high definition systems are equipped with our highest performance DVX series symmetric drive woofers and the DH7N 3" pure titanium compression driver.

EVF two-way full-range systems are offered in seven coverage patterns that provide solutions for the widest possible range of installation challenges. The 12" Constant Directivity waveguides can be rotated to work with a vertical or horizontal orientation. Biamp operation is supported, but the sophisticated fourth-order crossover and protection network makes cost-saving, passive operation extremely attractive. Using optional rigging accessories, you can create attractive clusters that include EVF full-range systems, as well as EVF subwoofers or EVH full-range systems. Cabinets are available in three finishes: EVCoat (interior use), PI (indirect weather exposure) or FG (fiberglass—for direct weather exposure); they include twenty-two M10 threaded suspension points.

EVF "S" STANDARD SERIES

EVF-1122S 12" TWO-WAY FULL-RANGE LOUSPEAKERS



- 2" ND2B titanium HF compression driver
- Rotatable Constant Directivity waveguide
- Six available patterns with coverage from 60° to 120°
- 98 dB sensitivity, 131 dB maximum SPL
- Power handling: 500 W continuous, 2000 W peak
- Fourth-order passive crossover with HF protection
- Trapezoidal 13-ply birch enclosure in three finishes: EVCoat, PI and FG
- Four M10 metric eyebolts included

EVF-1152S 15" TWO-WAY FULL-RANGE LOUSPEAKERS



- 2" ND2B titanium HF compression driver
- Rotatable Constant Directivity waveguide
- Six available patterns with coverage from 40° to 90°
- 101 dB sensitivity, 134 dB maximum SPL
- Power handling: 500 W continuous, 2000 W peak
- Fourth-order crossover with HF protection
- Trapezoidal 13-ply birch enclosure in three finishes: EVCoat, PI and FG
- Four M10 metric eyebolts included

See page 58–59 for EVF Rigging and Accessories.

EVF STANDARD 12" TWO-WAY SYSTEMS

	EVF-1122S/64	EVF-1122S/66	EVF-1122S/94	EVF-1122S/96	EVF-1122S/99	EVF-1122S/126
Frequency Response (-3 dB)				58 Hz – 16 kHz ^{1,2}		
Frequency Range (-10 dB)				49 Hz – 19 kHz ^{1,2}		
Recommended High-Pass Frequency				65 Hz		
Sensitivity (SPL, 1 W/1 m)				98 dB		
Max. SPL @ 1 m (calc.)				131 dB		
System Power Handling (Continuous ³ , Program, Peak)				500 W, 1000 W, 2000 W		
Nominal Impedance (Passive)				8 Ω		
Minimum Impedance				6 Ω		
Input Connections	Euroblock; PI and FG versions include dual-gland-nut input-panel cover					
Coverage (Nominal -6 dB) H° x V°	60° x 40°	60° x 60°	90° x 40°	90° x 60°	90° x 90°	120° x 60°
LF Transducer	12" SMX2121 driver					
HF Transducer	2" ND2B diaphragm compression driver					
Internal Passive Crossover Frequency	1,450 Hz					
Enclosure Material	13-ply weather-resistant birch					
Grille	Standard versions: 16 ga Galvalneal, Powdercoat with screen behind PI and FG versions: 18 ga Stainless, Powdercoat with hydrophobic cloth behind					
Environmental	Standard versions: IEC 60529 IP44 PI and FG versions: IEC 60529 IP55					
Suspension	22 M10 threaded suspension points (one EBK-M10-EVI kit of four forged eyebolts included)					
Dimensions (H x W x D)	30.26" x 16" x 16.27" (768.6 x 406.3 x 413.3 mm)					
Net Weight				63.1 lb (28.6 kg)		

¹ Half-space measurement in passive mode
² FG (full outdoors) versions have no enclosure vents, somewhat reducing their low frequency response
³ EIA RS-426A (eight hours)

EVF STANDARD 15" TWO-WAY SYSTEMS

	EVF-1152S/43	EVF-1152S/64	EVF-1152S/66	EVF-1152S/94	EVF-1152S/96	EVF-1152S/99
Frequency Response (-3 dB)				70 Hz – 14 kHz ^{1,2}		
Frequency Range (-10 dB)				41 Hz – 18 kHz ^{1,2}		
Recommended High-Pass Frequency				45 Hz		
Sensitivity (SPL, 1 W/1 m)				101 dB		
Max. SPL @ 1 m (calc.)				134 dB		
System Power Handling (Continuous ³ , Program, Peak)				500 W, 1000 W, 2000 W		
Nominal Impedance (Passive)				8 Ω		
Minimum Impedance				6 Ω		
Input Connections	Euroblock; PI and FG versions include dual-gland-nut input-panel cover					
Coverage (Nominal -6 dB) H° x V°	40° x 30°	60° x 40°	60° x 60°	90° x 40°	90° x 60°	90° x 90°
LF Transducer	15" SMX2151 driver					
HF Transducer	2" ND2B diaphragm compression driver					
Internal Passive Crossover Frequency	1,450 Hz					
Enclosure Material	13-ply weather-resistant birch					
Grille	Standard versions: 16 ga Galvalneal, Powdercoat with screen behind PI and FG versions: 18 ga Stainless, Powdercoat with hydrophobic cloth behind					
Environmental	Standard versions: IEC 60529 IP44 PI and FG versions: IEC 60529 IP55					
Suspension	22 M10 threaded suspension points (one EBK-M10-EVI kit of four forged eyebolts included)					
Dimensions (H x W x D)	30.26" x 18.5" x 18.37" (768.6 x 469.8 x 466.6 mm)					
Net Weight				70.9 lb (32.1 kg)		

¹ Half-space measurement in passive mode
² FG (full outdoors) versions have no enclosure vents, somewhat reducing their low frequency response
³ EIA RS-426A (eight hours)



EVF "D" HIGH DEFINITION SERIES

EVF "D" high definition systems are equipped with our highest performance DVX series symmetric drive woofers and the DH7N 3" pure titanium compression driver.

The result is lower distortion, cleaner sound reproduction at a given output level, compared with the equivalent "S" version.

EVF-1122D HIGH DEFINITION 12" TWO-WAY FULL-RANGE LOUDSPEAKERS



- 3" DH7N titanium/neodymium HF compression driver
- DVX3151A woofer with fully symmetric drive
- Rotatable Constant Directivity waveguide
- Six available patterns with coverage from 60° to 120°
- 97 dB sensitivity, 131 dB maximum SPL
- Power handling: 600 W continuous, 2400 W peak
- Fourth-order passive crossover with HF protection
- Trapezoidal 13-ply birch enclosure in three finishes: EVCoat, PI and FG
- 22 M10 threaded suspension points
- Transformer kit available for distributed systems
- Four M10 metric eyebolts included

EVF-1152D HIGH DEFINITION 15" TWO-WAY FULL-RANGE LOUDSPEAKERS



- Compact and lightweight
- Low distortion, high efficiency
- Ideal for fixed installations
- DVX3151A woofer with fully symmetric drive
- 3" DH7N titanium/neodymium HF compression driver
- Rotatable Constant Directivity waveguide
- Six available patterns with coverage from 40° to 90°
- 100 dB sensitivity, 134 dB maximum SPL
- Power handling: 600 W continuous, 2400 W peak
- Fourth-order crossover with HF protection
- Trapezoidal 13-ply birch enclosure in three finishes: EVCoat, PI and FG
- 22 M10 threaded suspension points
- Transformer kit available for distributed systems
- Four M10 metric eyebolts included

See pages 58–59 for EVF Rigging and Accessories.



EVF HIGH DEFINITION 12" TWO-WAY SYSTEMS

	EVF-1122D/64	EVF-1122D/66	EVF-1122D/94	EVF-1122D/96	EVF-1122D/99	EVF-1122D/126
Frequency Response (-3 dB)	57 Hz – 18 kHz ^{1,2}					
Frequency Range (-10 dB)	49 Hz – 21 kHz ^{1,2}					
Recommended High-Pass Frequency	65 Hz					
Sensitivity 1 W/1 m	97 dB					
Max. SPL/1 m (Calculated) ¹	131 dB					
System Power Handling (Continuous ³ , Program, Peak)	600 W, 1200 W, 2400 W					
Nominal Impedance (Passive)	8 Ω					
Minimum Impedance	6 Ω					
Input Connections	Euroblock; PI and FG versions include dual-gland-nut input-panel cover					
Coverage (Nominal -6 dB) H° x V°	60° x 40°	60° x 60°	90° x 40°	90° x 60°	90° x 90°	120° x 60°
LF Transducer	12" DVX3121A woofer					
HF Transducer	3" DH7N diaphragm compression driver					
Internal Passive Crossover Frequency	1,300 Hz					
Enclosure Material	13-ply weather-resistant birch					
Grille	Standard versions: 16 ga Galvalume, Powdercoat with screen behind PI and FG versions: 18 ga Stainless, Powdercoat with hydrophobic cloth behind					
Environmental	Standard versions: IEC 60529 IP44 PI and FG versions: IEC 60529 IP55					
Suspension	22 M10 threaded suspension points (one EBK-M10-EVI kit of four forged eyebolts included)					
Dimensions (H x W x D)	30.26" x 16.00" x 16.27" (768.6 x 406.3 x 413.3 mm)					
Net Weight	65.5 lb (29.7 kg)					

¹ Half-space measurement in passive mode
² FG (full outdoors) versions have no enclosure vents, somewhat reducing their low frequency response
³ EIA RS-426A (eight hours)

EVF HIGH DEFINITION 15" TWO-WAY SYSTEMS

	EVF-1152D/43	EVF-1152D/64	EVF-1152D/66	EVF-1152D/94	EVF-1152D/96	EVF-1152D/99
Frequency Response (-3 dB)	70 Hz – 18 kHz ^{1,2}					
Frequency Range (-10 dB)	40 Hz – 21 kHz ^{1,2}					
Recommended High-Pass Frequency	45 Hz					
Sensitivity 1 W/1 m	100 dB					
Max. SPL/1 m (Calculated) ¹	134 dB					
System Power Handling (Continuous ³ , Program, Peak)	600 W, 1200 W, 2400 W					
Nominal Impedance (Passive)	8 Ω					
Minimum Impedance	6 Ω					
Input Connections	Euroblock; PI and FG versions include dual-gland-nut input-panel cover					
Coverage (Nominal -6 dB) H° x V°	40° x 30°	60° x 40°	60° x 60°	90° x 40°	90° x 60°	90° x 90°
LF Transducer	15" DVX3151A woofer					
HF Transducer	3" DH7N diaphragm compression driver					
Internal Passive Crossover Frequency	1,300 Hz					
Enclosure Material	13-ply weather-resistant birch					
Grille	Standard versions: 16 ga Galvalume, Powdercoat with screen behind PI and FG versions: 18 ga Stainless, Powdercoat with hydrophobic cloth behind					
Environmental	Standard versions: IEC 60529 IP44 PI and FG versions: IEC 60529 IP55					
Suspension	22 M10 threaded suspension points (one EBK-M10-EVI kit of four forged eyebolts included)					
Dimensions (H x W x D)	30.26" x 18.5" x 18.37" (768.6 x 469.8 x 466.6 mm)					
Net Weight	75.7 lb (34.4 kg)					

¹ Half-space measurement in passive mode
² FG (full outdoors) versions have no enclosure vents, somewhat reducing their low frequency response
³ EIA RS-426A (eight hours)

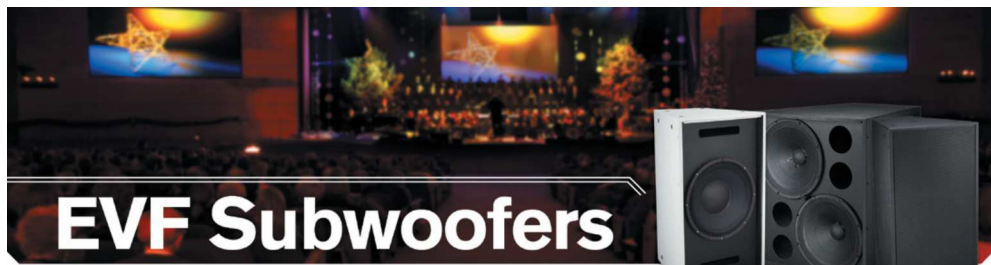

EVF Subwoofers

A range of acoustically and aesthetically matched front-loaded low-frequency systems are available to compliment your full-range systems. Cabinet heights are the same as those of EVF and EVH full-range loudspeakers systems, so you can create functional, attractive clusters using these low-frequency boxes with almost any combination of EVF and EVH loudspeakers.

EVF-1121S 12" FRONT-LOADED BASS ELEMENT



- Enhanced bass for installations
- Low-distortion EVS12SB woofer
- 99 dB sensitivity, 131 dB maximum SPL
- Power: 400 W continuous, 1600 W peak
- Trapezoidal 13-ply birch enclosure
- EVCoat, PI or FG finish
- 22 M10 threaded suspension points
- Four M10 metric eyebolts included

EVF-1151S 15" FRONT-LOADED BASS ELEMENT



- Enhanced bass for installations
- Low-distortion EVS15SB woofer
- 99 dB sensitivity, 131 dB maximum SPL
- Power: 400 W continuous, 1600 W peak
- Trapezoidal 13-ply birch enclosure
- EVCoat, PI or FG finish
- 22 M10 threaded suspension points
- Four M10 metric eyebolts included

EVF-1181S 18" FRONT-LOADED SUBWOOFER



- Ideal for installations
- Low-distortion EVS18SB woofer
- 99 dB sensitivity, 131 dB maximum SPL
- Power: 400 W continuous, 1600 W peak
- Trapezoidal 13-ply birch enclosure
- EVCoat, PI or FG finish
- 28 M10 threaded suspension points
- Four M10 metric eyebolts included

EVF-2121S DUAL 12" FRONT-LOADED SUBWOOFER



- Ideal for installations
- Low-distortion dual EVS12SB woofer
- 100 dB sensitivity, 135 dB maximum SPL
- Power: 800 W continuous, 3200 W peak
- Trapezoidal 13-ply birch enclosure
- EVCoat, PI or FG finish
- 22 M10 threaded suspension points
- Four M10 metric eyebolts included

EVF-2151D DUAL 15" FRONT-LOADED SUBWOOFER



- High power handling for installations
- Two premium DVX3159A woofers
- 101 dB sensitivity, 137 dB maximum SPL
- Power: 1000 W continuous, 4000 W peak
- Trapezoidal 13-ply birch enclosure
- EVCoat, PI or FG finish
- 28 M10 threaded suspension points
- Four M10 metric eyebolts included

See page 58–59 for EVF Sub Rigging and Accessories.

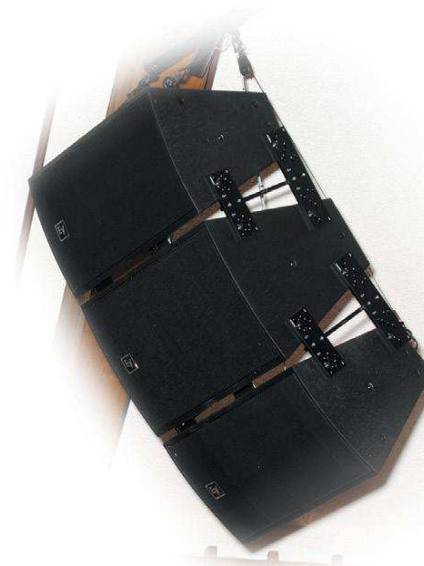

	EVF-1121S	EVF-1151S	EVF-2121S	EVF-1181S	EVF-2151D
Frequency Response (-3 dB)	70–98 Hz ^{1,2}	67–95 Hz ^{1,2}	54–145 Hz ^{1,2}	35–100 Hz ^{1,2}	40 Hz – 2.6 kHz ^{1,2}
Frequency Range (-10 dB)	48–120 Hz ^{1,2}	46–124 Hz ^{1,2}	41–330 Hz ^{1,2}	28–650 Hz ^{1,2}	30 Hz – 3.2 kHz ^{1,2}
Recommended High-Pass Frequency	50 Hz	35 Hz	45 Hz	33 Hz	35 Hz
Internal Passive Low-Pass Filter	100 Hz, 12 dB per octave	100 Hz, 12 dB per octave	None	None	None
Sensitivity (SPL, 1 W/1 m)	99 dB	99 dB	100 dB	99 dB	101 dB
Max. SPL @ 1 m (calc.)	131 dB	131 dB	135 dB	131 dB	137 dB
System Power Handling (Continuous ³ , Program, Peak)	400 W, 800 W, 1600 W	400 W, 800 W, 1600 W	800 W, 1600 W, 3200 W	400 W, 800 W, 1600 W	1000 W, 2000 W, 4000 W
Nominal Impedance	Passive: 4 Ω, Biamp: 8 Ω	Passive: 4 Ω, Biamp: 8 Ω	Passive: N/A, Biamp: 4 Ω	Passive: N/A, Biamp: 8 Ω	Passive: N/A, Biamp: 4 Ω
Minimum Impedance	Passive: 3.4 Ω, Biamp: 5.5 Ω	Passive: 3.4 Ω, Biamp: 6.4 Ω	Passive: N/A, Biamp: 2.8 Ω	Passive: N/A, Biamp: 6 Ω	Passive: N/A, Biamp: 2.7 Ω
Input Connections	Euroblock; PI and FG versions include dual gland nut input panel cover				
Coverage (Nominal -6 dB)	Omnidirectional in normal operating range				
Transducer	12" EVS12SB driver	15" EVS15SB driver	Two 12" EVS12SB driver	18" EVS18SB driver	Two 15" DVX3159A drivers
Enclosure Material	13-ply weather-resistant birch				
Grille	Standard versions: 16 ga Galvalume, Powdercoat with screen behind PI and FG versions: 18 ga Stainless, Powdercoat with hydrophobic cloth behind				
Environmental	Standard versions: IEC 60529 IP44 PI and FG versions: IEC 60529 IP55				
Suspension	22 M10 threaded suspension points (one EBK-M10-EVI kit of four forged eyebolts included)		28 M10 threaded suspension points (one EBK-M10-EVI kit of four forged eyebolts included)		
Dimensions (H x W x D)	30.26" x 18.07" x 16.27" (768.6 x 406 x 413.3 mm)	30.26" x 18.5" x 18.4" (768.6 x 470 x 467 mm)	30.26" x 18.5" x 18.4" (768.6 x 470 x 467 mm)	30.26" x 26.6" x 28.6" (768.6 x 675.6 x 726.4 mm)	30.26" x 26.6" x 28.6" (768.6 x 675.6 x 726.4 mm)
Net Weight	57.7 lb (26.2 kg)	62.6 lb (28.4 kg)	82.4 lb (37.4 kg)	101.2 lb (45.9 kg)	117 lb (53.1 kg)

¹ Half-space measurement in passive mode

² FG (full outdoors) versions have no enclosure vents, somewhat reducing their low frequency response

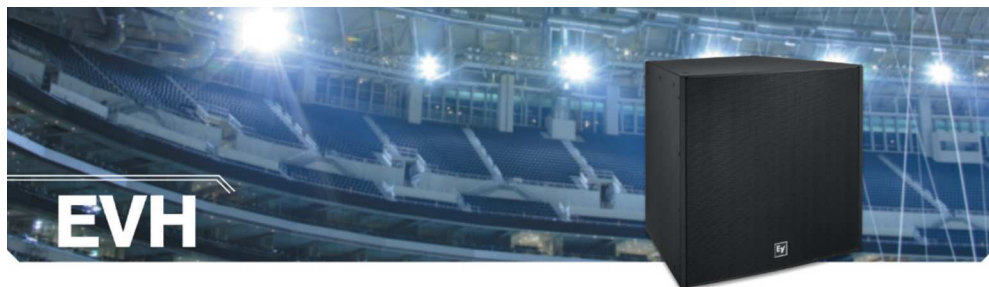

The EVH series is a dedicated installed sound solution that builds on everything Electro-Voice has learned about full-range, horn-loaded systems. Delivering exceptional value in venues of all sizes, these mid-sized 15" two-way cabinets feature a unique coaxial horn-loaded design that is unmatched for pattern control and intelligibility in reverberant environments.

A 400 W SMX2151 woofer provides the EVH's deep, rich lows, while horn loading extends directivity control below 500 Hz. High frequencies are handled by a pure titanium compression driver—either a standard 2" ("S" models) or a premium 3" with neodymium magnetic structure (high

definition "D" models)—protected by an advanced fourth-order crossover network. Six coverage patterns (ranging from 40° x 30° to 90° x 90°) on rotatable Constant Directivity waveguides offer extraordinary versatility.

Three finishes are available, including two for outdoor applications. EVH loudspeakers come installation-ready with 28 M10-threaded suspension points, making rigging extremely flexible. Wherever extended pattern control is a priority, the EVH series provides a proven, effective solution.

EVH systems are mechanically compatible with the EVF subs.

EVH-1152S TWO-WAY COAXIAL HORN-LOADED FULL-RANGE LOUDSPEAKERS



- Ideal for reverberant spaces
- Pattern control maintained below 500 Hz
- 15" SMX2151 woofer
- 2" ND2B titanium HF compression driver
- Rotatable Constant Directivity waveguide
- Six available coverage patterns from 40° x 30° to 90° x 90°
- 106 dB sensitivity, 139 dB maximum SPL
- Power handling: 500 W continuous, 2000 W peak
- Fourth-order passive crossover with HF protection
- Trapezoidal enclosure in three finishes: EVCoat, PI or FG
- 28 M10 threaded suspension points
- Four M10 metric eyebolts included

EVH-1152D HIGH DEFINITION TWO-WAY COAXIAL HORN-LOADED FULL-RANGE LOUDSPEAKERS



- Ideal for reverberant spaces
- Pattern control maintained below 500 Hz
- 15" SMX2151 woofer
- 3" DH7N titanium/neodymium HF compression driver
- Rotatable Constant Directivity waveguide
- Six available coverage patterns from 40° x 30° to 90° x 90°
- 106 dB sensitivity, 139 dB maximum SPL
- Power handling: 500 W continuous, 2000 W peak
- Fourth-order passive crossover with HF protection
- Trapezoidal enclosure in three finishes: EVCoat, PI or FG
- 28 M10 threaded suspension points
- Four M10 metric eyebolts included

EVH STANDARD TWO-WAY SYSTEMS

	EVH-1152S/43	EVH-1152S/64	EVH-1152S/66	EVH-1152S/94	EVH-1152S/96	EVH-1152S/99
Frequency Response (-3 dB)	60 Hz – 15 kHz ¹					
Frequency Range (-10 dB)	50 Hz – 20 kHz ¹					
Recommended High-Pass Frequency	60 Hz					
Sensitivity (SPL, 1 W/1 m)	106 dB	105 dB	105 dB	105 dB	105 dB	104 dB
Max. SPL @ 1 m (calc.)	139 dB	138 dB	138 dB	138 dB	138 dB	137 dB
System Power Handling (Continuous ² , Program, Peak)	500 W, 1000 W, 2000 W					
Nominal Impedance (Passive)	8 Ω					
Minimum Impedance	6 Ω					
Input Connections	Euroblock; PI and FG versions include dual-gland-nut input-panel cover					
Coverage (Nominal -6 dB) H° x V°	40° x 30°	60° x 40°	60° x 60°	90° x 40°	90° x 60°	90° x 90°
LF Transducer	15" SMX2151 driver					
HF Transducer	2" ND2B diaphragm compression driver					
Internal Passive Crossover Frequency	1,300 Hz					
Enclosure Material	13-ply weather-resistant birch					
Grille	Standard versions: 16 ga Galvanneal, Powdercoat with screen behind PI and FG versions: 18 ga Stainless, Powdercoat with hydrophobic cloth behind					
Environmental	Standard versions: IEC 60529 IP33 PI and FG versions: IEC 60529 IP55					
Suspension	28 M10 threaded suspension points (one EBK-M10-EVI kit of four forged eyebolts included)					
Dimensions (H x W x D)	30.26" x 30.26" x 26.77" (768.6 x 768.6 x 680.1 mm)					
Net Weight	143 lb (64.9 kg)					

EVH HIGH DEFINITION TWO-WAY SYSTEMS

	EVH-1152D/43	EVH-1152D/64	EVH-1152D/66	EVH-1152D/94	EVH-1152D/96	EVH-1152D/99
Frequency Response (-3 dB)	60 Hz – 17 kHz ¹					
Frequency Range (-10 dB)	50 Hz – 20 kHz ¹					
Recommended High-Pass Frequency	60 Hz					
Sensitivity (SPL, 1 W/1 m)	106 dB	105 dB	105 dB	105 dB	105 dB	104 dB
Max. SPL @ 1 m (calc.)	139 dB	138 dB	138 dB	138 dB	138 dB	137 dB
System Power Handling (Continuous ² , Program, Peak)	500 W, 1000 W, 2000 W					
Nominal Impedance (Passive)	8 Ω					
Minimum Impedance	6 Ω					
Input Connections	Euroblock; PI and FG versions include dual-gland-nut input-panel cover					
Coverage (Nominal -6 dB) H° x V°	40° x 30°	60° x 40°	60° x 60°	90° x 40°	90° x 60°	90° x 90°
LF Transducer	15" SMX2151 driver					
HF Transducer	3" DH7N diaphragm compression driver					
Internal Passive Crossover Frequency	1,300 Hz					
Enclosure Material	13-ply weather-resistant birch					
Grille	Standard versions: 16 ga Galvanneal, Powdercoat with screen behind PI and FG versions: 18 ga Stainless, Powdercoat with hydrophobic cloth behind					
Environmental	Standard versions: IEC 60529 IP33 PI and FG versions: IEC 60529 IP55					
Suspension	28 M10 threaded suspension points (one EBK-M10-EVI kit of four forged eyebolts included)					
Dimensions (H x W x D)	30.26" x 30.26" x 26.77" (768.6 x 768.6 x 680.1 mm)					
Net Weight	145.5 lb (66.1 kg)					

¹ Half-space measurement in passive mode
² EIA RS-426A (eight hours)

See page 58–59 for EVH Rigging and Accessories.



EVA

The Expandable Vertical Array (EVA) series is a vertical line array with a unique, elegant system design that provides a simple solution for installed sound applications. EVA offers true line array performance and coherent far-field summing from the patented Hydra plane wave generator. The internal, hidden rigging not only looks great, but also makes EVA incredibly easy to install. The sophisticated internal crossover lets you power up to eight EVA full-range

modules (16 line array elements) from a single amplifier channel, eliminating the need for external crossovers or DSP. The four full-range modules in the series are complemented by two matching subwoofers that can be flown in the array. If you think that your budget isn't big enough for a great sounding line array, EVA may be just the answer you're looking for.

Features:

- High performance, cost-effective
- Ideal for fixed installation line arrays
- Two array elements in each module
- Two 8" low-distortion woofers
- Four 1.25" titanium diaphragm HF drivers
- Advanced Hydra plane wave generators
- Constant Directivity waveguide

- High sensitivity (104 dB) for high output
- Super efficient: drive up to 8 boxes from a single amp channel
- Sixth-order passive crossover with HF protection
- Integrated hidden suspension hardware
- Choice of three finishes: indoor, PI and FG
- EVADA (EVA Design Assistant) software tool

EVA-2082S 126



DUAL-ELEMENT
120° BY 6°
FULL-RANGE LINE-
ARRAY MODULE

EVA-2082S 1220



DUAL-ELEMENT
120° BY 20°
FULL-RANGE LINE-
ARRAY MODULE

EVA-2082S 906



DUAL-ELEMENT
90° BY 6° FULL-RANGE
LINE-ARRAY MODULE

EVA-2082S 920



DUAL-ELEMENT
90° BY 20° FULL-RANGE
LINE-ARRAY MODULE

EVA SUBWOOFERS

Features:

- High power, front loaded
- Ideal for fixed installations
- Seamless rigging with EVA line arrays
- DVX3159A woofer for low distortion at high SPL
- Steel-reinforced 13-ply birch enclosure

EVA-1151D

15" SUBWOOFER LINE ARRAY ELEMENT



- DVX3159A woofer for low distortion at high SPL
- 98 dB sensitivity (1 W/1 m half space)
- Power handling: 500 W continuous, 2000 W peak
- 125/131 dB maximum SPL (continuous/peak)
- Integrated hidden suspension hardware
- Splays of 0° or 5° between modules
- Choice of three finishes: EVCoat, PI and FG

EVA-2151D

DUAL 15" SUBWOOFER LINE ARRAY ELEMENT



- Two DVX3159A woofers for low distortion at high SPL
- 100 dB sensitivity (1 W/1 m half space)
- Power handling: 1000 W continuous, 4000 W peak
- 130/136 dB maximum SPL (continuous/peak)
- Choice of two finishes: EVCoat and PI (EVA-2151D not available in FG version)

See page 58–59 for EVA Rigging and Accessories.

	EVA-2082S 1220	EVA-2082S 126	EVA-2082S 906	EVA-2082S 920	EVA-1151D	EVA-2151D
Frequency Response (-3 dB)		60 Hz – 19 kHz			48–250 Hz (half space)	38–200 Hz (half space)
Recommended High-Pass Frequency		50 Hz			35 Hz, 24 dB per Octave BW	32 Hz, 24 dB per Octave BW
Sensitivity (SPL, 1 W/1 m)		104 dB (3 module array)			98 dB, Arithmetic average, 55–100 Hz (half space)	100 dB, Arithmetic average, 55–100 Hz (half space)
Max. SPL @ 1 m (calc.)		135 dB			131 dB (half space)	130/133/136 dB (half space)
System Power Handling (Continuous, Program, Peak)		350, 700, 1400 W			500 W, 1000 W, 2000 W	1000 W, 2000 W, 4000 W
Nominal Impedance (Passive)		16 Ω			8 Ω	4 Ω
Input Connections		Euroblock				
Frequency Range (-10 dB)		45 Hz – 20 kHz			35–250 Hz (half space)	28–200 Hz (half space)
Coverage (Nominal -6 dB) H°	120°	120°	90°	90°	Omnidirectional	Omnidirectional
Coverage (Nominal -6 dB) V°	20°	6°	6°	20°	Omnidirectional	Omnidirectional
LF Transducer		Two 8" EVS2008 drivers			DVX3159A	Two DVX3159A
HF Transducer		Four 1.25" DH2005 diaphragm compression driver			None	None
Crossover Frequency		1,740 Hz			100 Hz active	100 Hz active
Minimum Impedance		12 Ω			5.8 Ω	2.8 Ω
Enclosure Material		Birch plywood				
Grille		16 ga Galvanneal, powder-coated; PI Version: stainless steel with hydrophobic cloth				
Suspension		EVA grid (sold separately)				
Dimensions (H x W x D)	20.17" x 23.5" x 14.53" (512.2 x 596.9 x 369.1 mm)	20.25" x 23.5" x 14.1" (514.4 x 596.9 x 358.2 mm)	20.25" x 23.5" x 14.1" (514.4 x 596.9 x 358.2 mm)	20.17" x 23.5" x 14.53" (512.2 x 596.9 x 369.1 mm)	23.5" x 23.5" x 18.16" (596.9 x 596.9 x 461.3 mm)	30.5" x 23.42" x 31.2" (930.4 x 597 x 792.5 mm)
Net Weight	81.0 lb (36.8 kg)	81.8 lb (37.1 kg)	81.8 lb (37.1 kg)	81.0 lb (36.8 kg)	89.1 lb (40.4 kg)	178 lb (80.8 kg)



Bringing ultracompact design to the EV Innovation family of installation loudspeakers, the EVU series shines in applications including delay, under-balcony fill, front-fill, wall mounting and distributed audio. EVU loudspeakers feature a rotatable Constant Directivity waveguide that provides truly uniform sound dispersion while allowing the horizontal coverage pattern to be independent of enclosure

orientation. Sonically matched to complement the other EV Innovation products, EVU helps make EV Innovation the industry's most comprehensive and versatile line of installed-sound loudspeakers.

A fourth-order, 90 Hz high-pass filter is recommended for use with all EVU loudspeakers.

Features:

- Sonically matched to all EV Innovation lines
- Sophisticated 18 dB octave passive crossover/EQ networks
- Asymmetrical enclosure for ideal under-balcony and stage-fill aiming
- Optional NL4-type connector panel
- One 1.3" diaphragm compression driver

- U-bracket included
- Optional 70 V and 100 V operation
- OmniMount-compatible rear mounting points
- Available in black or white (interior use)

EVU-1062/95



ULTRACOMPACT TWO-WAY WITH SINGLE 6.5" WOOFER

- Ultracompact 8" x 14.5" enclosure
- 90° x 50° rotatable Constant Directivity waveguide
- Ultra-high power handling for size: 160 W continuous
- 120 dB maximum SPL
- Asymmetrical trapezoidal enclosure design
- Compatible with OmniMount

EVU-2062/95



ULTRACOMPACT TWO-WAY WITH DUAL 6.5" WOOFERS

- Ultracompact 8" x 21" enclosure
- 90° x 50° rotatable Constant Directivity waveguide
- Ultra-high power handling for size: 300 W continuous
- 125 dB maximum SPL
- Asymmetrical trapezoidal enclosure design
- Compatible with OmniMount

EVU-1082/95



ULTRACOMPACT TWO-WAY WITH SINGLE 8" WOOFER

- Ultracompact 10 x 16" enclosure
- 90° x 50° rotatable Constant Directivity waveguide
- Ultra-high power handling for size: 175 W continuous
- 123 dB maximum SPL
- Asymmetrical trapezoidal enclosure design
- Compatible with OmniMount

EVU-2082/95



ULTRACOMPACT TWO-WAY WITH DUAL 8" WOOFERS

- Ultracompact 10 x 24" enclosure
- 90° x 50° rotatable Constant Directivity waveguide
- Ultra-high power handling for size: 350 W continuous
- 126 dB maximum SPL
- Asymmetrical trapezoidal enclosure design
- Compatible with OmniMount

See page 59 for EVU Rigging and Accessories.

	EVU-1062/95	EVU-2062/95	EVU-1082/95	EVU-2082/95
Frequency Response (-3 dB)	110 Hz - 16 kHz ¹	100 Hz - 16 kHz ¹	110 Hz - 16 kHz ¹	100 Hz - 16 kHz ¹
Frequency Response (-10 dB)	65 Hz - 20 kHz ¹	70 Hz - 20 kHz ¹	65 Hz - 20 kHz ¹	60 Hz - 20 kHz ¹
Recommended High-Pass Frequency	90 Hz	90 Hz	90 Hz	90 Hz
Axial Sensitivity (1 W/1 m)	92 dB	94 dB	95 dB	95 dB
Maximum SPL (calc.) Continuous, Peak	114, 120 dB	119, 125 dB	117, 123 dB	120, 126 dB
Waveguide	6" x 6", rotatable	6" x 6", rotatable	6" x 6", rotatable	6" x 6", rotatable
Horizontal Coverage	90°	90°	90°	90°
Vertical Coverage	50°	50°	50°	50°
Power Handling (Continuous, Peak)	160, 640 W ²	300, 1200 W ²	175, 700 W ²	350, 1400 W ²
LF Transducer	6.5" CT-6.5-8 woofer	Two 6.5" CT-6.5-8 woofers	8" CT-8-8 woofer	Two 8" CT-8-8 woofers
HF Transducer	1.3" diaphragm (CT-1-8) compression driver	1.3" diaphragm (CT-1-8) compression driver	1.3" diaphragm (CT-1-8) compression driver	1.3" diaphragm (CT-1-8) compression driver
Nominal Impedance	8 Ω	8 Ω	8 Ω	8 Ω
Minimum Impedance	6 Ω	6 Ω	6 Ω	6 Ω
Connectors	4-pin Euroblock (up to 10 AWG wire)	4-pin Euroblock (up to 10 AWG wire)	4-pin Euroblock (up to 10 AWG wire)	4-pin Euroblock (up to 10 AWG wire)
Enclosure Material	9-ply hardwood plywood	9-ply hardwood plywood	9-ply hardwood plywood	9-ply hardwood plywood
Minimum Impedance	Textured paint	Textured paint	Textured paint	Textured paint
Color	Black or white	Black or white	Black or white	Black or white
Grille, Standard Versions	18 ga steel with cloth behind	18 ga steel with cloth behind	18 ga steel with cloth behind	18 ga steel with cloth behind
Suspension	Six M8 threaded points	Six M8 threaded points	Six M8 threaded points	Six M8 threaded points
Dimensions (H x W x D)	8.91" x 14.6" x 8.14" (203 x 370 x 207 mm)	8.91" x 21.0" x 8.14" (203 x 533 x 207 mm)	9.75" x 16.1" x 9.34" (247 x 409 x 237 mm)	9.75" x 24.0" x 9.34" (247 x 615 x 237 mm)
Net Weight	14.4 lb (6.53 kg)	25.0 lb (11.3 kg)	16.3 lb (7.40 kg)	28.3 lb (12.8 kg)

¹ Half-space measurement
² EIA RS-496A (eight hours)



EVI VARIABLE INTENSITY COVERAGE PATTERN (3-2-1 RULE):

If speaker mount-height = H, then coverage length = 3H, coverage width = 2H and first row coverage = 1H

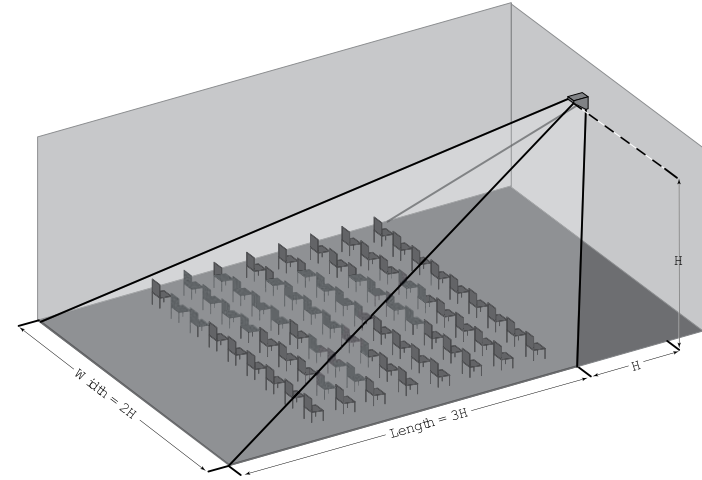

EVI provides a simple, economical solution for permanent installations requiring even coverage over a fixed rectangular area. In a typical room, the distance from a front-mounted loudspeaker to the last row is two or more times the distance to the front row, resulting in a substantial front-to-back difference in level and

intelligibility. The Variable Intensity horn counters this problem by increasing the sound sent to the back of the room by six to eight dB, balancing SPL distribution without the expense and complexity of additional systems or components.

EVI-12 12" TWO-WAY VARIABLE INTENSITY LOUDSPEAKER



- Variable Intensity horn for even coverage
- Two-way, full-range loudspeaker
- High sensitivity
- Vented LF enclosure
- 1.25" HF driver with titanium diaphragm
- PRO™ Driver protection circuit
- Multi-angled housing
- Five 3/8" hanging points

EVI-15 15" TWO-WAY VARIABLE INTENSITY LOUDSPEAKER



- Variable Intensity horn for even coverage
- Two-way, full-range loudspeaker
- High sensitivity
- Vented LF enclosure
- 1.25" HF driver with titanium diaphragm
- PRO™ Driver protection circuit
- Multi-angled housing
- Five 3/8" hanging points

EVI-28 DUAL 8" TWO-WAY VARIABLE INTENSITY LOUDSPEAKER



- Ideal for reverberant spaces
- Variable Intensity horn for even coverage
- Two-way, full-range loudspeaker
- Vented LF enclosure
- 1.25" HF driver with titanium diaphragm
- PRO™ Driver protection circuit
- Multi-angled housing
- Stacked, frequency-shaded woofers for pattern control below 500 Hz
- Three 3/8" hanging points

	EVI-12	EVI-15	EVI-28
Frequency Response (-10 dB)	50 Hz – 20 kHz	50 Hz – 20 kHz	60 Hz – 20 kHz
Sensitivity (SPL 1 W/1 m)	99 dB	100 dB	93 dB
Max. SPL/1m (calc.)	129 dB	130 dB	123 dB
Power Handling (Continuous, Peak)	250 W, 1000 W	250 W, 1000 W	250 W, 1000 W
Coverage, H x V	60° x 70° long throw, 110° x 90° short throw	65° x 65° long throw, 110° x 65° short throw	65° x 65° long throw, 110° x 65° short throw
LF Transducer	12"	15"	Two 8"
HF Transducer	1.25" DH3/2010A compression driver (1" exit)	1.25" DH3/2010A compression driver (1" exit)	1.25" DH3/2010A compression driver (1" exit)
Crossover frequency	2,000 Hz	2,000 Hz	2,000 Hz
Nominal impedance (minimum)	8 Ω	8 Ω	8 Ω
Input connections	Screw terminal	Screw terminal	Screw terminal
Dimensions (H x W at front x D)	21.8" x 14" x 27.5" (554 x 356 x 699 mm)	23" x 16.9" x 30.2" (584 x 429 x 766 mm)	13.9" x 19.5" x 20.6" (353 x 496 x 523 mm)
Net Weight	48 lb (21.8 kg)	53 lb (24.0 kg)	36 lb (16.3 kg)

See page 59 for EVI Rigging and Accessories.



EVID

EVID SURFACE-MOUNT SYSTEMS

EVID premium commercial loudspeakers bring best-in-class sonic characteristics and stunning high fidelity to a broad range of installation applications, including performance and sports venues, retail environments, conference and meeting rooms, and hospitality settings, such as restaurants and bars. Available in both flush-mount

and surface-mount configurations, EVID loudspeakers feature innovative designs that beautify not only the sound of a room but also its looks. EVID 3.2, 4.2 and 6.2 models are available in "T"-designated versions with internal 70 or 100 V line transformer. High power and high performance, EVID is the superior solution to today's installation needs.

EVID 3.2 DUAL 3.5" TWO-WAY SURFACE-MOUNT LOUDSPEAKER



- Ultra-compact full-range
- Ideal for restaurants, bars, patios and retail
- Vented LF enclosure
- 0.75" titanium diaphragm HF driver with neodymium magnetic structure
- Full-bandwidth overload protection (LF and HF)

- Elliptical weather-resistant ABS enclosure
- Paintable black or white finish
- Magnetically shielded for video applications
- Strong-Arm Mount for easy, flexible aiming
- "T" version for 70 or 100 V distributed systems

EVID 4.2 DUAL 4" TWO-WAY SURFACE-MOUNT LOUDSPEAKER



- Compact full-range
- Ideal for restaurants, bars, patios and retail
- Vented LF enclosure
- 1" titanium diaphragm HF driver with neodymium magnetic structure
- Coherent Coverage Waveguide

- Full-bandwidth overload protection (LF and HF)
- Elliptical weather-resistant ABS enclosure
- Paintable black or white finish
- Magnetically shielded for video applications
- Strong-Arm Mount for easy, flexible aiming
- "T" version for 70 or 100 V distributed systems

EVID 6.2 DUAL 6" TWO-WAY SURFACE-MOUNT LOUDSPEAKER



- Compact full-range
- Ideal for shopping malls, sports bars and health clubs
- Vented LF enclosure
- 1" titanium diaphragm HF driver with neodymium magnetic structure
- Coherent Coverage Waveguide

- Full-bandwidth overload protection (LF and HF)
- Elliptical weather-resistant ABS enclosure
- Paintable black or white finish
- Magnetically shielded for video applications
- Strong-Arm Mount for easy, flexible aiming
- "T" version for 70 or 100 V distributed systems

EVID 3.2, EVID 4.2 AND EVID 6.2 INCLUDED

EV's Strong-Arm Mount (SAM) comes with each EVID system and includes a hex key tool. SAM has angle markers to make installation easier.

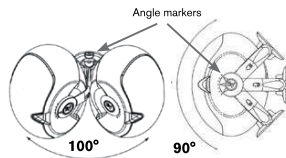

EVID 12.1



12" CORNER-MOUNT, DUAL VOICE COIL SUBWOOFER

- Supplemental bass for indoor systems
- Ideal for sports bars, dance floors, retail and health clubs
- High-excursion woofer with dual voice coil to accommodate L/R channels
- High sensitivity, high power-handling
- Crossed-over pass-thru for up to four satellite speakers
- Trapezoidal shape for flexible placement and optimal bass loading

- Steel-reinforced cabinet with mounting hardware included
- Paintable black or white finish
- One 3/8" 16-thread forged steel eyebolt is included. A second is necessary for hanging.
- The mounting bracket passes EIA 636 at a safety factor of 8:1 and included for on-wall or corner mounting.

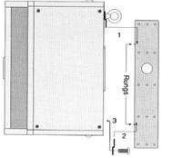

EVID IN-WALL SPEAKER SYSTEMS

EVID FM 4.2



4" TWO-WAY FLUSH-MOUNT LOUDSPEAKER

- Shallow profile, ideal for tight wall or ceiling spaces
- Tuned passive radiator extends bass, enhances performance
- High quality 1" titanium dome tweeter
- Full-bandwidth overload protection
- 70 V, 100 V and 8 Ω operation in the same model for off-the-shelf versatility
- Front-panel mode/wattage switch

- Fully-sealed enclosure provides superior isolation to protect adjacent rooms
- Secure Phoenix-style pass-through connectors for easy wiring and installation
- Four point "quick mounting" tabs for fast attachment in any wall cavity
- Can-mounted transformer for enhanced rigidity
- Ribbed back can eliminates flexing

EVID FM 6.2



6" TWO-WAY FLUSH-MOUNT LOUDSPEAKER

- Shallow profile, ideal for tight wall or ceiling spaces
- Tuned passive radiator extends bass, enhances performance
- High quality 1" titanium dome tweeter
- Full-bandwidth overload protection
- 70 V, 100 V and 8 Ω operation in the same model for off-the-shelf versatility
- Front-panel mode/wattage selector

- Fully-sealed enclosure provides superior isolation to protect adjacent rooms
- Secure Phoenix-style pass-through connectors for easy wiring and installation.
- Four point "quick mounting" tabs for fast attachment in any wall cavity
- Can-mounted transformer for enhanced rigidity
- Ribbed back can eliminates flexing

See page 60 for EVID Rigging and Accessories.

	EVID 3.2	EVID 4.2	EVID 6.2	EVID 12.1	EVID FM 4.2	EVID FM 6.2
Frequency Range (-10 dB)	85 Hz – 20 kHz	65 Hz – 20 kHz	62 Hz – 20 kHz	40–140 Hz	52 Hz – 20 kHz	52 Hz – 20 kHz
Sensitivity (SPL, 1 W/1 m)	87 dB	89 dB	94 dB	100 dB (1/4 space)	87 dB	90 dB
Max. SPL/1m (calc.)	112 dB	115 dB	122 dB	128 dB (1/4 space)	110 dB	115 dB
Power Handling (Continuous, Peak)	75 W, 300 W	100 W, 400 W	150 W, 600 W	175 W, 700 W (per coil)	50 W, 200 W	75 W, 300 W
Transformer taps (transformer version only)	70 V: 5 W 100 V: 10 W	70 V: 3.75 W 70 V/100 V: 7.5, 15, 30 W	70 V: 7.5 W 70 V/100 V: 15, 30, 60 W		70 V: 1.75, 3.75, 7.5, 15, 30 W	70 V: 7.5, 15, 30, 60 W
Coverage, H x V	140° x 100°	120° x 80°	100° x 80°		150° x 150°	120° x 120°
LF Transducer	Two 3.5"	Two 4"	Two 6"	12"	4", plus 4" passive radiator	6", plus 6" passive radiator
HF Transducer	0.75"	1"	1"		1" (titanium dome)	1" (titanium dome)
Nominal impedance (non-transformer version)	8 Ω	8 Ω	8 Ω	8 Ω	8 Ω	8 Ω
Minimum impedance (non-transformer version)	6 Ω	6 Ω	6 Ω	6 Ω		
Input connections	Spring terminal	Spring terminal	Spring terminal	Spring terminal	4-pin Phoenix	4-pin Phoenix
Dimensions (H x W at front x D)	9.2" x 5.1" x 6.5" (234 x 127 x 165 mm)	12.2" x 6.9" x 8.5" (310 x 175 x 216 mm)	16.5" x 9" x 11.75" (419 x 228 x 298 mm)	16.25" x 23" x 12" (412 x 584 x 305 mm)	13.78" x 7.41" x 3.76" (350 x 188.3 x 95.6 mm)	18.31" x 10.08" x 3.95" (465 x 256 x 100.3 mm)
Net Weight (incl. mounting bracket)	3.3 lb (1.5 kg)	8.5 lb (3.9 kg)	12 lb (5.3 kg)	40 lb (18.1 kg)	6.39 lb (2.9 kg)	12.79 lb (5.8 kg)



EVID

Designed with both the contractor and listener in mind, EVID ceiling speakers are high-performance problem-solvers that deliver exceptional sound in even the most challenging situations. From the compact power of the C4.2 to the exclusive waveguide-coupled design of the C8.2HC, each great-sounding EVID solution is uniquely suited to

handle installer needs across a specific range of intended applications. Sonically superior and aesthetically pleasing, every EVID ceiling model installs with ease and provides lasting value. For commercial sound across all venue types, EVID has the ceiling covered.

EVID C4.2 4" TWO-WAY COAXIAL CEILING LOUDSPEAKER



- Designed for use in air-handling spaces
- Ported enclosure for extended bass response
- Waveguide-coupled 0.75" titanium-coated tweeter
- Full-bandwidth overload protection
- Integrated transformer for 70 V, 100 V or 8 Ω use
- Front-panel mode/wattage selector
- Safe, easy installation with included tile bridge and mounting ring
- Available in black or white
- Complete package, requires no additional accessories

EVID C8.2
EVID C8.2LP 8" TWO-WAY COAXIAL CEILING LOUDSPEAKER



- Ported enclosure for extended bass response
- Waveguide-coupled 1" titanium-coated tweeter
- Full-bandwidth overload protection
- Integrated transformer for 70 V, 100 V or 8 Ω use
- Front-panel mode/wattage selector
- Safe, easy installation with included tile bridge and mounting ring
- Complete package, requires no additional accessories
- Low-profile LP version delivers rich sound in tight spaces
- EVID C8.2 available in black or white

EVID C8.2HC 8" PATTERN-CONTROL TWO-WAY COAXIAL CEILING LOUDSPEAKER



- Maximum fidelity and intelligibility for high ceilings
- Ported enclosure for extended bass response
- Waveguide-coupled 1" titanium-coated tweeter
- Full-bandwidth overload protection
- Integrated transformer for 70 V, 100 V or 8 Ω use
- Front-panel mode/wattage selector
- Safe, easy installation with included tile bridge and mounting ring
- White semi-gloss perforated grille
- Complete package, requires no additional accessories

EVID C10.1 10" HIGH-POWER CEILING SUBWOOFER



- Supplemental LF for ceiling systems
- High-excursion woofer in ported enclosure for extended lows
- Low pass network with overload protection
- Integrated transformer for 70 V, 100 V or 8 Ω use
- Front-panel mode/wattage selector
- Internally damped heavy-gauge steel enclosure
- Safe, easy installation with included tile bridge and mounting ring
- White semi-gloss perforated grille
- Complete package, requires no additional accessories

EVID C12.2 12" TWO-WAY COAXIAL CEILING LOUDSPEAKER



- Full-range power for high ceilings, large spaces
- High sensitivity, high power-handling
- Integrated transformer with automatic saturation compensation for distortion-free 70 V, 100 V or 8 Ω use
- Front-panel mode/wattage selector
- White semi-gloss perforated grille
- Heavy-gauge steel enclosure in black
- 3/8" threaded-rod mount points for open ceilings
- Safe, easy installation with included tile bridge and mounting ring
- Complete package, requires no additional accessories

EVID PC 6.2 6.5-INCH TWO-WAY CEILING LOUDSPEAKERS



- High-performance EV-engineered compression driver. Ultra-wide HF dispersion provides extremely even coverage through room.
- High-excursion woofer provides dramatic low-end frequency extension. Reinforced steel back can provide rigid enclosure to minimize acoustic loss.
- Four-point clamp mechanism and integrated mounting legs enable quick ceiling installation.
- Detachable pass-thru Phoenix-style signal connections simplify installation wiring. Tap selector with 8Ω / 70 V / 100 V operation.
- Fully reinforced ABS UL-rated baffle ensures long life. Fully compliant with EN 54 (pending), UL 1480, and 2043 standards.

EVID PC 8.2 8-INCH TWO-WAY CEILING LOUDSPEAKERS



- High-performance EV-engineered compression driver. Ultra-wide HF dispersion provides extremely even coverage through room.
- High-excursion woofer provides dramatic low-end frequency extension. Reinforced steel back can provide rigid enclosure to minimize acoustic loss.
- Four-point clamp mechanism and integrated mounting legs enable quick ceiling installation.
- Detachable pass-thru Phoenix-style signal connections simplify installation wiring. Tap selector with 8Ω / 70 V / 100 V operation.
- Fully reinforced ABS UL-rated baffle ensures long life. Fully compliant with EN 54 (pending), UL 1480, and 2043 standards.

	EVID C4.2	EVID C8.2 EVID C8.2LP	EVID C8.2HC	EVID C12.2	EVID C10.1	EVID PC 6.2	EVID PC 8.2
Frequency Range (-10 dB)	65 Hz – 20 kHz	50 Hz – 20 kHz	50 Hz – 20 kHz	65 Hz – 20 kHz	45–180 Hz	50 - 20kHz	40 - 20kHz
Sensitivity (SPL, 1 W @ 1 m)	86 dB	91 dB	93 dB	100 dB	94 dB	95 dB	96 dB
Power Handling (8 Ω)	80 W (overload protected)	100 W (overload protected)	100 W (overload protected)	100 W	150 W	200 W program, 100 W pink noise Watts	
Coverage Pattern	130° conical	110° conical	75° conical (@ >1 kHz)	90° average	180°	120°	100°
Transformer Power Taps	1.88 (70 V only), 3.75, 7.5, 15, 30 W	1.88 (70 V only), 3.75, 7.5, 15, 30 W	7.5 (70 V only), 15, 30, 60 W	4 (70 V only), 8, 16, 32, 64 W ASC protected	60 W	70 V: 60 W, 30 W, 15 W, 7.5 W, 8 ohm 100 V: 60 W, 30 W, 15 W, 8 ohm	
LF Transducer	4" polypropylene cone	8" polypropylene cone	8" polypropylene cone plus waveguide	12" EVID 920-8B (coax)	10" polypropylene cone	6.5" (165 mm)	8" (200 mm)
HF Transducer	0.75" Ti Mylar Laminate Dome	1" Ti Mylar Laminate Dome	1" Ti Mylar Laminate Dome	1" coax		35 mm compression driver	
Input Configuration	8 Ω / 70 V / 100 V	8 Ω / 70 V / 100 V	8 Ω / 70 V / 100 V	8 Ω / 70 V / 100 V	8 Ω / 70 V / 100 V		8 Ω
Dimensions (H x Diameter)	6.93" x 7.13" (176 x 181 mm)	7.01" x 10.63" (178 x 270 mm) 10.04" x 10.63" (255 x 270 mm)	11.99" x 12.60" (303 x 320 mm)	13.18" x 16.31" (333 x 414 mm)	11.99" x 12.60" (303 x 320 mm)	10.24" x 9.76" (260 x 248 mm)	12.76" x 11.59" (324 x 294 mm)
Net Weight	6.0 lb (2.7 kg)	11.0 lb (5.0 kg)	13.2 lb (6.0 kg)	27.12 lb (12.3 kg)	15.4 lb (7.0 kg)	7 kg (15.4 lbs)	8 kg (17.64 lbs)
Acoustic Design	Ported cabinet, internally damped, two-way (passive crossover included)				Dual ported cabinet, internally damped		
Cabinet Construction	Steel enclosure and UL94V-0 rated baffle and bezel				ABS plastic (UL94V-0) baffle, steel back can		
Mounting System	Integrated 3-point toggle anchors						
Grille Construction	Powder-coated steel				Color-matched steel grille with fabric		
Available Colors	White (paintable surface)						

EVID Compact Sound



The new EVID Compact Sound speaker series joins the globally popular EVID (EV Innovative Design) family of small-format installed audio products from Electro-Voice.

EVID Compact Sound is designed to offer an unparalleled performance-to-size ratio in the small-format installed sound category. The series includes five sonically and aesthetically matched models which allow complete systems to be customized more effectively and more

economically: subwoofer and satellite speakers for surface-mounting, subwoofer and satellite speakers for ceilings, and a pendant speaker.

Individual models may be mixed with one another for optimal results according to application, and all stand apart from other available products by providing a unique combination of superior EV sound quality, stylish design, smaller size, and simpler installation.

SURFACE-MOUNT SPEAKERS

EVID 2.1 SATELLITE SPEAKERS



- 2" wide-range mid/high-frequency driver designed for broad, even coverage.
- Multi-angle compact mounting bracket system allows for a variety of speaker angles.
- Rigid high-impact ABS enclosure for durability.

EVID 40S SUBWOOFER



- High-performance EV-engineered 8" transducer with high-efficiency multi-mode audio crossover network.
- Compact, high-density wood enclosure with port for extended bass response, secure snap-on speaker grille, and quick-mount slide-on bracket system.
- Easy-access signal connections with Phoenix-style connectors for quick wiring, user-friendly mode selector for stereo or mono operation, and easy-tap selector dial (supports 4/8 ohm inputs or up to 100 W / 70/100 V audio connections).



**FLEXIBLE, SCALABLE
BACKGROUND MUSIC (BGM)
SOLUTION FOR A WIDE RANGE OF
ARCHITECTURAL ENVIRONMENTS,
INCLUDING RETAIL SPACES,
OFFICES, AND RESTAURANTS.**

CEILING SPEAKERS

EVID C2.1 SATELLITE SPEAKERS



- Four-pin Phoenix connectors on ceiling satellite speakers support pass-thru wiring.

EVID 40C SUBWOOFER



- Quick-install design with captive mounting tabs to fit nearly any ceiling construction.
- UL 2043/1480 ratings allow for use in signaling applications and plenum air spaces.
- Ceiling cutout templates and all mounting accessories included.

PENDANT MOUNT SPEAKER

EVID P2.1 PENDANT SPEAKER



- 2" full-range transducer – acoustically matched to ceiling and surface-mount satellite versions.
- Attractive compact design.
- Concealed wire connection with pass-thru Phoenix plug for easy wiring.
- UL-rated quick-mount pendant cable included.
- Designed to be exclusively used with either the Compact Sound Ceiling or Surface mount subwoofers.

	EVID 40S	EVID 2.1	EVID 40C	EVID C2.1	EVID P2.1
Frequency Response (-10dB) ¹	42 Hz - 300 Hz	180 Hz - 20 kHz	45 Hz - 300 kHz	180 Hz - 20 kHz	180 Hz - 20 kHz
Power Handling ²	200 W	30 W	200 W	30 W	30 W
Sensitivity ¹	88 dB	84 dB	88 dB	84 dB	84 dB
Impedance	Dual 8 ohm / mono 4 ohm	16 ohms	mono 4 ohm	16 ohms	16 ohms
Maximum SPL ¹	114 dB	100 dB	114 dB	100 dB	100 dB
Voice Coverage (H x V) ³	Omnidirectional	150° x 150°	Omnidirectional	150° x 150°	150° x 150°
Music Program Coverage (H x V)	Omnidirectional	100° x 100°	Omnidirectional	100° x 100°	100° x 100°
Transducer	200 mm (7.87 in)	50 mm (1.97 in)	200 mm (7.87 in)	50 mm (1.07 in)	50 mm (1.07 in)
Bracket Adjustment Range (H x V)	Fixed	160° x 60°	N/A	N/A	N/A
Connectors	Phoenix (2-pin)	Phoenix (2-pin)	Phoenix (2-pin)	Phoenix (4-pin)	Phoenix (4-pin)
Enclosure	Wood (MDF)	ABS (fire rated)	Steel & ABS (fire rated)	Steel & ABS (fire rated)	ABS (fire rated)
Transformer Taps	100 W, 50 W, 25 W, 12.5 W	N/A	100 W, 50 W, 25 W, 12.5 W	N/A	N/A
Dimensions (H x W x D)	400 mm x 400 mm x 230 mm (15.75 in x 15.75 in x 9.06 in)	115 mm x 85 mm x 95 mm (4.53 in x 3.35 in x 3.75 in)	316 mm x 373 mm (12.44 in x 14.69 in)	119 mm x 135 mm (4.7 in x 5.3 in)	201 mm x 113 mm (7.92 in x 4.45 in)
Net Weight	12.05 kg (26.55 lb)	0.5 kg (1.1 lb)	9.52 kg (21 lb)	0.82 kg (1.8 lb)	0.73 kg (1.6 lb)
Shipping Weight	1 sub and 4 satellites: 18.26 kg (40.25 lb)		1 sub and 4 satellites: 19.05 kg (42 lb)		2.04 kg (4.5 lb)
Included Accessories	Wall bracket; hex wrench	Wall bracket; hex wrench	C-Ring, Tile Rails	C-Ring	Suspension cable



Specialty Loudspeakers

S-40

ULTRACOMPACT 5.25" TWO-WAY FULL-RANGE LOUDSPEAKER

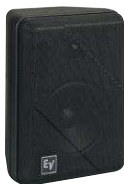

Delivering high performance in an ultra-compact package, the S-40 is ideal for both distributed and near-field applications requiring high-quality sound. The two-way short-throw system is housed in an optimally vented, high-impact polystyrene enclosure that is suited for installation both indoors and out. Lows are handled by a 5.25" direct-radiating woofer with a polypropylene cone, while the high-frequency section is a

1" direct-radiating soft-dome tweeter that is ferrofluid cooled. Built-in automatic power limiting independently protects each driver from unsafe transients. With mounting options that are flexible enough for virtually any application, the S-40 is perfect for anything from background and foreground music in restaurants and clubs to near-field monitoring in control rooms and broadcast studios.

- Ideal for both distributed and near-field applications
- Designed for indoor and outdoor use
- Direct-radiating polypropylene-cone woofer
- 1" ferrofluid-cooled soft-dome tweeter
- High power-handling, ultra-linear frequency response
- Vented trapezoidal enclosure of high-impact polystyrene
- Passive crossover with power protection for both woofer and tweeter
- Two OmniMount-compatible 0.25" suspension points

FRI-2082 FRI-28LPM

DUAL 8" TWO-WAY FULL-RANGE LOUDSPEAKER



This speaker remains one of our most popular choices for speech reinforcement, for under-balcony and on-wall locations in permanent installations, and as a high-quality monitor system. Dual 8" drivers in a tuned enclosure are matched to a 1" titanium compression driver with a 100° x 100° Constant Directivity waveguide.

The FRI-2082 comes with a mounting bracket for horizontal or vertical orientation, while the FRI-28LPM has non-skid rubber mounting feet to make it more appropriate for stage monitoring.

- Ultra-compact LF-optimized vented enclosure
- 1" HF driver on Constant Directivity waveguide
- 100° H x 100° V coverage pattern
- Low-profile slanted design
- Versatile 45° aiming angle for under-balcony, on-wall and stage monitoring applications
- Mounting bracket included (FRI-2082 only)
- Two 3/8" suspension points

	S-40
Frequency Response (+/- 3 dB)	85 Hz - 20 kHz
Sensitivity (SPL, 1 W @ 1 m)	85 dB
Max. SPL/1m (calc.)	113 dB
Power handling (Long-term, Short-term)	120 W, 480 W
Coverage, H x V	100° x 100°
Directivity Index	9.8 dB (+3.8/-3.6 dB), 2-20,000 Hz
LF Transducer	5.25"
HF Transducer	1" softdome
Crossover frequencies	3,500 Hz
Nominal impedance (low Z version)	4 Ω
Minimum impedance (low Z version)	3.7 Ω
Input connections	Spring terminal
Dimensions (H x W at front x D)	9.8" x 7" x 5.9" (249 x 178 x 150 mm)
Net Weight (including mounting bracket)	5.7 lb (2.6 kg)

	FRI-2082 & FRI-28LPM
Frequency Response (-3dB)	70 Hz - 20 kHz
Frequency Range (-10 dB)	55 Hz - 16 kHz
Recommended High-Pass Frequency	50 Hz (12 dB/octave)
Axial Sensitivity, Blamp (SPL, 1 W @ 1 m)	93 dB
Max. SPL /1 m (calc.), full space	122 dB
Power Handling, Blamp (Continuous, Peak)	200 W, 800 W
Coverage (nominal -6 dB) H x V	100° x 100° (Const. Dir. waveguide)
LF Transducer	Two 8"
HF Transducer	1" compression driver
Crossover Frequency	2,800 Hz
Nominal Impedance (Blamp)	8 Ω
Input Connections	Barrier strip
Dimensions (H x W at front x D)	8.75" x 24.5" x 14" (222 x 620 x 356 mm)
Net Weight	40 lb (18.2 kg)

See page 60 for S-40 and page 55 for FRI-2082 Rigging and Accessories.

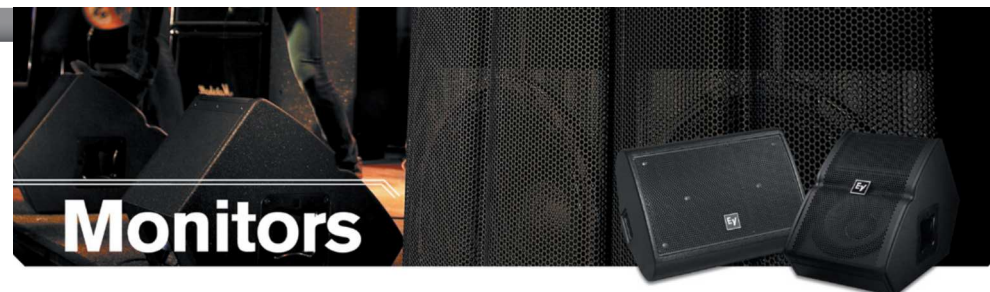

Monitors

CONCERT MONITORS

Our top-of-the-line floor monitors, originally designed as part of the X-Array touring line.

- Two-way, high-output design
- Vented LF enclosure
- Two symmetrical 55° enclosure angles
- Ultra compact for all-size stages

Xw12A 12" TWO-WAY FLOOR MONITOR



- DL12ST woofer with Ring-Mode Decoupling for vocal clarity

TOUR X FLOOR MONITORS

- Compact with high output
- Ideal for small-to-medium stages
- Signal Synchronized Transducers™ for woofer/tweeter alignment
- 1.25" DH3/2010A titanium HF compression driver

TX1122FM 12" TWO-WAY FULL-RANGE MONITOR



- Low-distortion SMX2121 woofer with fully symmetric drive
- 99 dB sensitivity, 132 dB maximum SPL

	Xw12A	Xw15A
Frequency Response (-3 dB)	65 Hz - 18 kHz	55 Hz - 18 kHz
Recommended High-Pass Frequency	System controller determined	System controller determined
Axial Sensitivity (SPL, 1 W @ 1 m), LF/HF	98/110 dB	99/110 dB
Max. SPL @ 1 m (calc.), full space, LF/HF	129/135 dB	133/135 dB
Long-Term Power Handling, LF/HF	300/75 W	600/75 W
Short-Term Power Handling (peak), LF/HF	1200/300 W	2400/300 W
Coverage (nominal -6 dB) H° x V°	55° x 80° (Const. Dir. waveguide)	55° x 80° (Const. Dir. waveguide)
Directivity Index	11.6 dB (+2.3/-2.1 dB), 1,200-16,000 Hz	11.6 dB (+3.0/-3.6 dB), 1,200-16,000 Hz
LF woofer (transducer)	12" DL12ST	15" EVX155
HF throat diameter (transducer)	1.4" ND6-16	1.4" ND6-16
Crossover Frequencies	Factory preset	Factory preset
Nominal Impedance, LF/HF	8 Ω/16 Ω	8 Ω/16 Ω
Minimum Impedance, LF/HF	8.2 Ω/10.5 Ω	7.2 Ω/14.3 Ω
Input Connections	2 four-pin Speakon	2 four-pin Speakon
Dimensions in floor position (H x W at front x D)	23" x 17.2" x 12.2" (534 x 449 x 313 mm)	25.4" x 18.3" x 13.4" (644 x 452 x 340 mm)
Net Weight	48 lb (21.9 kg)	62.5 lb (28.4 kg)

See page 44 for Tour X Loudspeakers.

Xw15A 15" TWO-WAY FLOOR MONITOR



- EVX155 woofer with 4" voice coil

- 90° H x 50° V Constant Directivity waveguide
- Integrated 24 dB/octave crossover with HF protection
- Power handling: 500 W continuous, 2000 W peak
- Black EVCoat finish

TX1152FM 15" TWO-WAY FULL-RANGE MONITOR



- Ultra low-distortion SMX2151 woofer with fully symmetric drive
- 100 dB sensitivity, 133 dB maximum SPL

	TX1122FM	TX1152FM
Speaker Type	Full-range	Full-range
Frequency Response (-3 dB)	70 Hz - 20 kHz	65 Hz - 20 kHz
Frequency Range (-10 dB)	55 Hz - 20 kHz	45 Hz - 20 kHz
Sensitivity (SPL, 1 W/1 m)	99 dB (1 W/1 m)	100 dB
Max. SPL/1m (calc.)	132 dB	133 dB
System Power Handling (Continuous, Peak)	500 W, 2000 W	500 W, 2000 W
Coverage (Nominal -6 dB)	90° H x 50° V	90° H x 50° V
LF Transducer	12" SMX2121	15" SMX2151
HF Transducer	1.25" DH3/2010A	1.25" DH3/2010A
Internal Crossover	Yes	Yes
Crossover Frequency	1,600 Hz	1,750 Hz
Nominal Impedance (Passive)	8 Ω	8 Ω
Minimum Impedance	6.4 Ω	6.2 Ω
Input Connections	Parallel Neutrik NL4	Parallel Neutrik NL4
Enclosure Material	Plywood and MDF with EVCoat	Plywood and MDF with EVCoat
Flying Suspension	Six 3/8" threaded inserts	Six 3/8" threaded inserts
Dimensions (H x W x D)	17.3" x 14.3" x 22.6" (440 x 364 x 573 mm)	18.7" x 17.3" x 25.8" (475 x 439 x 655 mm)
Net Weight	43.7 lb (19.8 kg)	51.9 lb (23.5 kg)

See page 44 for Tour X Loudspeakers.



EVM12L

Known for huge tone, gorgeous low-end and incredible stability at extreme volumes, the EVM12L Classic 12" musical instrument loudspeaker has been a favorite since its introduction in 1983. For an even louder, harder tone there's the EVM-12L Black Label, the official guitar loudspeaker of Zakk Wylde and Black Label Society, which

features improved power handling, magnet design and venting. Either way, guitarists and bassists love how tough the EVM12L sounds—and how tough it is. For the world's most punishing players, there's only one guitar speaker line that delivers the goods night after night, tour after tour: the Electro-Voice EVM-12L.

EVM12L Classic WORLD'S GREATEST GUITAR LOUDSPEAKER



- Classic sound with road-ready reliability
- Favorite of guitarists in all styles
- High-performance heavy-duty design
- 200 W Power handling
- Frequency response: 80 Hz – 7 kHz (-10 dB)
- Heavy-duty cast frame for reduced low-frequency flex
- Large 16 lb (7.3 kg) magnet assembly

EVM12L Black Label ZAKK WYLDE SIGNATURE GUITAR SPEAKER



- Official guitar loudspeaker of Zakk Wylde and Black Label Society
- EVM-12L sound with enhanced magnet design and venting
- 300 W power handling
- Frequency response: 80 Hz – 7 kHz (-10 dB)
- Sensitivity 100 dB
- Large 16 lb (7.3 kg) magnet assembly

	EVM12L Classic	EVM12L Black Label
Cone Diameter	12" (305 mm)	12" (305 mm)
Coil Diameter	2.5" (63.5 mm)	2.5" (63.5 mm)
Frequency Range (-10 dB)	80 Hz – 7 kHz	80 Hz – 7 kHz
Power Handling: Continuous (EIA), Peak	200, 1000 W	300, 1200 W
Sensitivity (SPL, 1 W @ 1 m)	100 dB	100 dB
Maximum SPL	125 dB	125 dB
Efficiency	5.9%	5.9%
Impedance	8 Ω	8 Ω
Frame Front Diameter	12.19" (309.6 mm)	12.19" (309.6 mm)
Magnet Diameter	7.5" (190.5 mm)	7.5" (190.5 mm)
Overall Depth	5.25" (133.4 mm)	5.25" (133.4 mm)
Mounting Bolt Circle Diameter	11.56" (293.7 mm)	11.56" (293.7 mm)
Baffle Cutout Diameter	11.06" (281.0 mm)	11.06" (281.0 mm)
Net Weight	19 lb (8.6 kg)	19 lb (8.6 kg)



ZX/ZXA

Designed for top-notch quality with amazing versatility, the ZX/ZXA series sets a new standard of performance and practicality in sound reinforcement loudspeakers. Featuring high-end components and lightweight molded enclosures, the ZX/ZXA line is at home in any installed or portable application, from commercial sound to clubs, houses of worship, stages, arenas and stadiums. Newly-designed high-power woofers and drivers ensure full-range sound

with awesome richness and clarity. Sleek contemporary styling fits in anywhere. Lightweight makes transport easy while enabling a multitude of flying and mounting options that are each supported by innovative mechanical solutions. Whether for portable use or permanent installation, the ZX/ZXA series represents the next level in advanced loudspeaker technology.

ZX1 8" TWO-WAY FULL-RANGE COMPOSITE LOUDSPEAKER



- Smooth, wide frequency response
- Ideal for mains, fills or monitors
- Velocity-compensated port for exceptional LF
- Long-excursion weather-treated EV8L woofer
- 1.25" DH2005 titanium HF compression driver
- Rotatable 90° x 50° waveguide for flexible coverage
- Passive crossover with full-band overload protection
- High sensitivity, 123 dB maximum SPL
- Power handling: 200 W continuous, 800 W peak
- High-impact polypropylene enclosure
- Compact monitor-friendly wedge shape
- Integrated pole mount adapter and pocket handle
- Four Metric mounting inserts
- Available in black or white

ZX1i 8" TWO-WAY FULL-RANGE INDOOR/OUTDOOR LOUDSPEAKER



- Install version of the ZX1
- Indoor/outdoor design
- Ideal for installed mains, fills or distributed sound
- Velocity-compensated port for exceptional LF
- Long-excursion weather-treated EV8L woofer
- 1.25" DH2005 titanium HF compression driver
- Choice of 90° x 50° or 100° x 100° rotatable waveguide
- Passive crossover with full-band overload protection
- Also available in 70/100 volt transformer version with Electro-Voice patented ASC (Automatic Saturation Compensation)
- High sensitivity, 123 dB maximum SPL
- Power handling: 200 W continuous, 800 W peak
- Compact high-impact polypropylene enclosure
- Integrated QuickSAM heavy-duty Strong-Arm Mounting bracket
- Paintable black or white finish

ZX1-SUB 12" PASSIVE SUBWOOFER



- 15 mm plywood enclosure, internally braced, with textured paint
- EVS-12S 12" woofer for powerful, engaging bass response
- Pole mount for full-range systems

ZX3 12" TWO-WAY FULL-RANGE LOUDSPEAKER



- Versatile performance for mains, fills or monitors
- DVX3121A woofer with forced-air cooling
- 2" ND2 titanium/neodymium HF driver
- Passive crossover
- Choice of 90° x 50° or 60° x 60° coverage waveguide
- High sensitivity, 131 dB maximum SPL
- Power handling: 600 W continuous, 2400 W peak
- High-impact polypropylene enclosure
- Compact monitor-friendly wedge shape
- Up to four anchor-plate attachments
- Seven M8 mounting inserts
- Integrated handle
- Available in black and white

ZX4 15" TWO-WAY FULL-RANGE LOUDSPEAKER



- Perfect for portable mains and monitors
- EVS15-SF woofer
- 1.25" DH3/2010A titanium HF driver
- Passive crossover
- 90° x 50° coverage waveguide
- High sensitivity, 132 dB maximum SPL
- Power handling: 400 W continuous, 1600 W peak
- Lightweight high-impact polypropylene enclosure
- Wedge shape for monitors at 45° or 55°
- Integrated pole mount adapter and pocket handle
- Mounting via attachment plates or eyebolts
- Black finish

ZX5 ALL-WEATHER 15" TWO-WAY FULL-RANGE LOUDSPEAKER



- Versatile performance for mains, fills or monitors
- DVX3150A woofer with forced-air cooling
- 2" ND2 titanium/neodymium HF driver
- Switchable biamp or passive crossover operation
- Choice of 90° x 50° or 60° x 60° coverage waveguide
- High sensitivity, 132 dB maximum SPL
- Power handling: 600 W continuous, 2400 W peak
- High-impact polypropylene enclosure
- Wedge shape for monitors at 45° or 55°
- Up to five anchor-plate attachments
- Ten M8 mounting inserts
- Integrated handle
- Available in black or white

ZXA1 POWERED 8" TWO-WAY FULL-RANGE LOUDSPEAKER



- Powered ZX1, ideal for portable and monitor use
- Integrated 800 W 2-channel (biamp) amplifier
- Long-excursion weather-treated EV8L woofer
- 1.25" DH2005 titanium HF compression driver
- Rotatable 90° x 50° waveguide for flexible coverage
- Steep crossover slopes and transducer protection
- 123 dB maximum SPL
- Microphone and line level inputs
- Switchable high-pass filter for use with subwoofer
- Compact wedge-shape enclosure of lightweight impact-resistant polystyrene
- Integrated pole mount adapter and pocket handle
- Four #8-32 suspension points for installation
- Available in black or white

ZXA1-SUB 12" POWERED SUBWOOFER



- 15 mm plywood enclosure, internally braced, with textured paint
- EVS-12S 12" woofer for powerful, engaging bass response
- Class D lightweight amplifier
- Pole mount for full-range systems
- Dual XLR inputs and outputs
- Switchable EQ modes for different applications
- LED indicators for power on and limit

ZXA5 POWERED 15" TWO-WAY FULL-RANGE LOUDSPEAKER



- Ideal for both portable and installation use
- Integrated 2-channel amplifier, 1000 W LF, 250 W HF
- DVX3150A woofer with forced-air cooling
- 2" ND2 titanium/neodymium HF driver
- 90° x 50° coverage waveguide
- High sensitivity, 133 dB maximum SPL
- Switchable high-pass filter for use with subwoofer
- PowerCon connector with slave through
- Compact enclosure of high-impact polypropylene
- Wedge shape for monitors at 45° or 55°
- Integrated handle
- Up to five anchor-plate attachments
- Ten M8 mounting inserts
- Available in black or white



	ZX1	ZX1i	ZX1-SUB	ZX3	ZX4	ZX5	ZXA1	ZXA5	ZXA1-SUB
Speaker Type	Full-range, mid-high two-way, wedges	Full-range, mid-high two-way	Passive Subwoofer	Full-range	Full-range, mid-high two-way, wedges	Full-range, mid-high two-way, wedges	Full-range, powered monitors, powered speakers, two-way, wedges	Full-range, powered monitors, powered speakers, two-way, wedges	Powered Subwoofer
Frequency Response (-3 dB)	60 Hz – 20 kHz	60 Hz – 20 kHz	53–125 Hz ¹	58 Hz – 15 kHz	60 Hz – 20 kHz	58 Hz – 18 kHz	60 Hz – 20 kHz (full-range mode)	58 Hz – 18 kHz	53–93 Hz ¹
Frequency Range (-10 dB)	48 Hz – 20 kHz	48 Hz – 20 kHz	42–200 Hz ¹	48 Hz – 20 kHz	42 Hz – 20 kHz	39 Hz – 20 kHz	48 Hz – 20 kHz (full-range mode)	50 Hz – 20 kHz	44–118 Hz ¹
Sensitivity (SPL, 1 W/1 m)	94 dB	94 dB	94 dB	97 dB	100 dB	98 dB			
Max. SPL/1m (calc)	123 dB	123 dB	127 dB ^{1,2}	131 dB	132 dB	132 dB	123 dB	133 dB	126 dB ^{1,2}
Power Handling (Continuous, Peak)	200, 800 W	200, 800 W	400 W Cont, 800 W Prog, 1600 W Peak	600, 2400 W	400, 1600 W	600, 2400 W			700 W
Coverage (Nominal -6 dB)	90° x 50° rotatable	90° x 50° rotatable 100° x 100° rotatable	Omnidirectional	90° H x 50° V 60° H x 60° V	90° H x 50° V	90° H x 50° V 60° H x 60° V	90° x 50° rotatable	90° H x 50° V 60° H x 60° V	Omnidirectional
LF Transducer	8" EV8L	8" EV8L	12" EVS-12S Woofer	12" DVX3121A	15" EVS15-SF	15" DVX3150A	8" EV8L	15" DVX3150A	12" EVS-12S Woofer
HF Transducer	1.25" DH2005	1.25" DH2005		2" ND2	1.25" DH3/2010A	2" ND2	1.25" DH2005	2" ND2	
Recommended High-Pass Frequency	40 Hz	40 Hz		50 Hz	42 Hz	36 Hz	36 Hz	100 Hz (user selectable)	
Nominal Impedance (Passive)	8 Ω	8 Ω	8 Ω	8 Ω	8 Ω	8 Ω			
Input Connections	Parallel Neutrik NL4 Speaker	4-pin Phoenix	Two NL4	2 conductor SJO cable and gland nut	Parallel Neutrik NL4	Parallel Neutrik NL4	XLR and TRS Combo; XLR with Independent Gain	XLR	Two XLR Stereo Input
Internal Crossover	Yes	Yes		Yes	Yes	Switchable biamp or passive crossover			
Crossover Frequency	17 kHz	17 kHz		2 kHz	1,500 Hz	1,500 Hz	1,800 Hz	1,500 Hz	100 Hz
Minimum Impedance	6 Ω	6 Ω	75 Ω	62 Ω	65 Ω	65 Ω			
Amplifier Power (RMS)							800 W	1250 W	800 W
Power Requirement							120V: 95V–132V, 50–60 Hz, 0.6A 230V: 190V–264V, 50–60 Hz, 0.4A	120V: 90V–132V, 50–60 Hz, 1.0A 230V: 190V–264V, 50–60 Hz, 0.6A	120V: 90V–132V, 50–60 Hz, 1.0A 230V: 190V–264V, 50–60 Hz, 0.6A
Enclosure Material	High-Impact Polystyrene	High-Impact Polystyrene	9-ply, 15 mm plywood, internally braced with textured paint	High-Impact Polystyrene	High-Impact Polystyrene	High-Impact Polystyrene	High-Impact Polystyrene	High-Impact Polystyrene	9-ply, 15 mm plywood, internally braced with textured paint
Grille	Polyester Powder Coated, 18 ga Galvanized Steel	Polyester Powder Coated, 18 ga Galvanized Steel	16 ga Steel with Black Powder Coat	Polyester Powder Coated, 18 ga Galvanized Steel	Polyester Powder Coated, 18 ga Galvanized Steel	Polyester Powder Coated, 18 ga Galvanized Steel	Polyester Powder Coated, 18 ga Galvanized Steel	Polyester Powder Coated, 18 ga Galvanized Steel	16 ga Steel with Black Powder Coat
Flying	No	Yes	No	Yes	Yes	Yes	No	Yes	No
Outdoor	No	Yes	No	Yes	No	Yes	No	No	No
Color	Black	Black, white	Black	Black, white	Black	Black, white	Black	Black, white	Black
Dimensions (H x W x D)	17.98" x 11.12" x 10.38" (457 x 282 x 264 mm)	17.68" x 11.1" x 10.35" (448 x 281 x 263 mm)	15.75" x 17.50" x 18.00" (400 x 444.5 x 457.2 mm)	24.14" x 15.64" x 14.26" (613 x 397 x 362 mm)	27.01" x 17.52" x 15.98" (686 x 445 x 406 mm)	27.24" x 17.56" x 16.18" (692 x 446 x 411 mm)	27.24" x 17.56" x 16.18" (692 x 446 x 411 mm)	27.24" x 17.56" x 16.18" (692 x 446 x 411 mm)	15.75" x 17.50" x 18.00" (400 x 444.5 x 457.2 mm)
Net Weight	18.52 lb (8.4 kg)	18.52 lb (8.4 kg)	43.6 lb (19.8 kg)	43.65 lb (19.8 kg)	44.53 lb (20.2 kg)	48.94 lb (22.2 kg)	19 lb (8.62 kg)	50.49 lb (22.9 kg)	46.0 lb (20.9 kg)

¹ Half-Space

² Typical maximum SPL value at one meter over the usable frequency range, measured with a pink-noise burst signal, using internal signal processing and amplifier driven to peak output.



The SX series includes some of the most popular loudspeaker designs in history. SX loudspeakers offer the tour-proven performance and reliability for which EV is known. A versatile range of speaker configurations and lightweight enclosures covers applications in commercial sound, pro music, club sound, and performance and sports venues. In live performance, the SX line can handle tasks, such as front-of-house, side fills, delay lines or stage monitors. For installed sound, easy mounting and

multiple weather-ready versions provide flexible system configuration for both indoor and outdoor venues. With high power-handling, great coverage, and smooth, consistent frequency response, cost-effective SX loudspeakers are the hard-working, easy-setup solution to your installation and portable system needs.

Sx300E 12" TWO-WAY FULL-RANGE LOUDSPEAKER



- Compact, portable sound reinforcement
- Designed for use alone or in arrays
- Cast-frame DL12BFH woofer
- 1.25" DH3/2010A titanium HF compression driver
- 65° x 65° Constant Directivity waveguide
- Ring-Mode Decoupling (RMD) for increased intelligibility
- Power handling: 300 W continuous, 1200 W peak
- Dual Neutrik Speakon high-current connectors
- Trapezoidal black or white polypropylene enclosure
- Rubber feet and mating sockets for stacking
- Integral handles, pole mount

Sx300PI
Sx300PIX WEATHER-RESISTANT 12" TWO-WAY FULL-RANGE LOUDSPEAKERS



- Sx300 performance with enhanced weather-resistance
- PIX version has multi-tap transformer for 70 or 100 V use
- Ideal for installation, alone or in arrays
- 1.25" DH3/2010A titanium HF compression driver
- 65° x 65° Constant Directivity waveguide
- Ring-Mode Decoupling (RMD) for increased intelligibility
- Power handling: 300 W continuous, 1200 W peak
- Neutrik Speakon (PI) or Phoenix (PIX) connectors
- Trapezoidal enclosure of high-impact polypropylene
- Rubber feet and mating sockets for stacking
- Integral handles, pole socket, suspension points
- Available in black or white

Sx600PI
Sx600PIX WEATHER-RESISTANT DUAL-ELEMENT FULL-RANGE LINE ARRAY



- High output with exceptional outdoor performance
- Ideal for arenas, stadiums and race tracks
- 600 W multi-tap transformer (PIX only) for 70 or 100 V use
- High intelligibility at high SPL (139 dB max)
- Cast-frame 12" DL12BFH woofer
- Neodymium-based 12" ND12A mid-driver
- 2" DH2T titanium HF compression driver
- 65° x 65° Constant Directivity waveguide
- Very high sensitivity (105 dB 1 W / 1 m)
- Power handling: 600 W continuous, 2400 W peak
- Lightweight trapezoidal polypropylene enclosure
- SuperSAM mounting system adjusts 60° V and 180° H

SB122 COMPACT 12" SUBWOOFER



- SB122 performance with enhanced weather-resistance
- Low-pass filter for parallel connection without added amp
- Large vent for enhanced LF output
- Cast-frame EVS12SB long-excursion woofer
- Power handling: 400 W continuous, 1600 W peak
- Parallel Neutrik Speakon high current input connectors
- Strong, composite trapezoidal enclosure
- Pole mount on top for pairing with ZX1
- Integral handle
- Available in black

	Sx300 (all)	Sx600 (all)	SB122
Frequency Range (-10 dB)	50 Hz – 20 kHz	70 Hz – 16 kHz	43–200 Hz
Recommended High-Pass Frequency		90 Hz	40 Hz (12 dB/octave)
Axial Sensitivity, Blamp (SPL, 1 W @ 1 m)	99 dB	105 dB	99 dB (half space)
Max. SPL @ 1 m (calc), full space	Low Z: 131 dB 100V: 123 dB	139 dB	131 dB (half space)
Power Handling (Long-term, Short-term), Low Z	300, 1200 W	600, 2400 W	400, 1600 W
Coverage (nominal -6 dB) H x V	65° x 65° (Const. Dir. waveguide)	65° x 65° (Const. Dir. waveguide)	Omnidirectional
Directivity Index (800–16,000 Hz)	11.1 dB (+2.4/-4.1 dB)	11.3 dB	
LF Transducers	12" DL12BFH	12" DL12BFH (LF), 12" ND12A (MB)	12" EVS12SB
HF Transducer	1.25" DH3/2010A	2" DH2T	
Crossover Frequencies	1,500 Hz	1,800 Hz	80–160 Hz
Nominal Impedance (non-transformer)	8 Ω	4 Ω	8 Ω
Minimum Impedance (non-transformer)	5.0 Ω	3.5 Ω	6.0 Ω
Input Connections	2 four-pin Speakon	SJO cable/gland nut	2 four-pin Speakon
Dimensions (H x W at front x D)	23.07" x 16.89" x 12.28" (586 x 429 x 312 mm)	45.79" x 16.89" x 12.28" (1163 x 429 x 312 mm)	23.07" x 16.89" x 12.28" (586 x 429 x 312 mm)
Net Weight	31.97 lb (14.5 kg) PIX: 39.0 lb (17.7 kg)	80 lb (36.3 kg)	33 lb (14.6 kg)

See page 60 for Sx300 and SB122 Rigging and Accessories.



QRx

The QRx series has become the standard for regional sound companies, rental professionals and contractors who want compact high-performance loudspeakers with concert-grade EV components. Covered with rugged EVCoat, QRx looks great stacked, on poles, as monitors or flown with simple, integrated, L-track rigging points. Unique, fully-rotatable asymmetrical waveguides have a 15-degree downward bias to ensure high-frequency

coverage without the need to tilt the enclosure toward the audience. Our powerhouse DH7 large-format driver (3" voice-coil, 1.4" exit) provides the high-frequency engine, while a selection of DL and EVX woofers anchor the low and sub frequencies. The combination of high-level components, unique design and versatility make QRx series one of the best values in the industry.

QRx 112/75 12" TWO-WAY FULL-RANGE LOUDSPEAKER



- Compact with high output
- Ideal for mains (small-to-medium rooms) or monitors
- Cast-frame woofer, vented cabinet for extended LF
- 3" DH7 titanium HF compression driver
- Rotatable 75° x 50° Constant Directivity waveguide
- Asymmetric 10° down-angled coverage
- Externally switchable biamped or passive operation
- High sensitivity, 131 dB maximum SPL (peak)
- Power handling: 300 W continuous, 1200 W peak
- 5-sided 13-ply birch enclosure with monitor slant
- Built-in handles and L-Track rigging
- Black or white

QRx 115/75 15" TWO-WAY FULL-RANGE LOUDSPEAKER



- Compact with high output
- Ideal for mains (small-to-medium rooms) or monitors
- Cast-frame woofer, vented cabinet for extended LF
- 3" DH7 titanium HF compression driver
- Rotatable 75° x 50° Constant Directivity waveguide
- Asymmetric 10° down-angled coverage
- Externally switchable biamped or passive operation
- High sensitivity, 130 dB maximum SPL (peak)
- Power handling: 400 W continuous, 1600 W peak
- 5-sided 13-ply birch enclosure with monitor slant
- Built-in handles and L-Track rigging
- Black or white

QRx 118S COMPACT 18" SUBWOOFER



- Concert-proven high-output performance
- Accurate transient detail
- EVX-180B woofer for superior linear excursion
- High sensitivity, 137 dB maximum SPL (peak)
- Power handling: 600 W continuous, 2400 W peak
- Rectangular 13-ply birch vented enclosure
- Built-in handles and 1 3/8" pole-mount receptacle
- Four threaded T-nuts for casters or dollies
- Black EVCoat finish

QRx 153/75 15" THREE-WAY FULL-RANGE LOUDSPEAKER



- Compact with high-level, high-fidelity sound
- Cast-frame DL15ST woofer, vented box for extended LF
- Horn-loaded 8" MF8 midrange driver
- 3" DH7 titanium HF compression driver
- Asymmetric (10° down-angled) 75° H x 50° V coverage
- Biamped operation
- High sensitivity, 130 dB maximum SPL
- Power handling: 400 W continuous, 1600 W peak
- Trapezoidal (15"/side) 13-ply birch enclosure
- Built-in handles and L-Track rigging
- Black EVCoat finish

QRx 212/75 DUAL 12" TWO-WAY FULL-RANGE LOUDSPEAKER



- Full-range performance with extra-full lows
- Ideal for mains in small-to-medium rooms
- Cast-frame woofer, vented cabinet for extended LF
- 3" DH7 titanium HF compression driver
- Rotatable 75° x 50° Constant Directivity waveguide
- Asymmetric 10° down-angled coverage
- Externally switchable biamped or passive operation
- High sensitivity, 135 dB maximum SPL (peak)
- Power handling: 600 W continuous, 2400 W peak
- Trapezoidal 13-ply birch enclosure
- Built-in handles and L-Track rigging
- Black or white

QRx 212H/75 DUAL 12" TWO-WAY FULL-RANGE LOUDSPEAKER



- Full-range performance with extra-full lows
- Ideal for mains in small-to-medium rooms
- Cast-frame woofer, vented cabinet for extended LF
- 3" DH7 titanium HF compression driver
- Rotatable 75° x 50° Constant Directivity waveguide
- Asymmetric 10° down-angled coverage
- Externally switchable biamped or passive operation
- High sensitivity, 133 dB maximum SPL (peak)
- Power handling: 600 W continuous, 2400 W peak
- Trapezoidal 13-ply birch enclosure
- Built-in handles and L-Track rigging
- Black or white

QRx 218S COMPACT DUAL 18" SUBWOOFER



- High-level extended LF with concert-proven performance
- Accurate transient detail
- Available in Standard and Riggable (L-Track) versions
- EVX-180B woofers for superior linear excursion
- High sensitivity, 139 dB maximum SPL (peak)
- Power handling: 1200 W continuous, 4800 W peak
- Rectangular 13-ply birch vented enclosure
- Built-in handles and sealed pocket wheels (Standard)
- Integrated pole-mount receptacle (Standard)
- Black EVCoat finish

	QRx 112/75	QRx 115/75	QRx 153/75	QRx 212/75	QRx 212H/75	QRx 118S	QRx 218S
Frequency Response (-3 dB)	75 Hz - 15 kHz	60 Hz - 15 kHz	50 Hz - 16 kHz	75 Hz - 16 kHz	75 Hz - 15 kHz	45-150 Hz	38-125 Hz
Frequency Range (-10 dB)	52 Hz - 18 kHz	45 Hz - 16 kHz	42 Hz - 20 kHz	52 Hz - 18 kHz	52 Hz - 18 kHz	30-250 Hz	31-250 Hz
Recommended High-Pass Frequency	45 Hz (12 dB/octave)	45 Hz (12 dB/octave)	45 Hz (12 dB/octave)	45 Hz (12 dB/octave)	45 Hz (12 dB/octave)	36 Hz (12 dB/octave)	35 Hz (12 dB/octave)
Axial Sensitivity (SPL, 1 W @ 1 m) (Blamp operation)	98 dB Passive (100/112 dB)	98 dB (96/110 dB)	98/105 dB	102 dB (102/112 dB)	100 dB Passive (100/112 dB)	98 dB	102 dB
Max. SPL @ 1 m (calc.)	131 dB	130 dB	130 dB	135 dB	133 dB	137 dB ¹	139 dB
Power Handling (Continuous, Peak)	350, 1400 W	450, 1800 W		600, 2400 W	600, 2400 W	600, 2400 W	1200, 4800 W
Power Handling, Biamp: Continuous Peak	LF 300 W/HF 75 W LF 1200 W/HF 300 W	LF 400 W/HF 75 W LF 1600 W/HF 300 W	LF 400 W/MB+HF 150 W LF 1600 W/MB+HF 600 W	LF 600 W/HF 75 W LF 2400 W/HF 300 W	LF 600 W/HF 75 W LF 2400 W/HF 300 W	LF 600 W/HF 75 W LF 2400 W/HF 300 W	
Coverage (nominal -6 dB) H x V	75° x 50° (up 15°, down 35°)	75° x 50° (up 15°, down 35°)	75° x 50° (up 15°, down 35°)	75° x 50° (up 15°, down 35°)	75° x 50° (up 15°, down 35°)	Omnidirectional	Omnidirectional
LF Transducer	12" DL12BFH	15" DL15X	15" DL15ST	Two 12" DL12BFH	12" DL12ST 12" DL12BFH	18" EVX-180B	Two 18" EVX-180B
HF Transducer	3" DH7	3" DH7	MF: 8" MF8 HF: 3" DH7	3" DH7	3" DH7		
Crossover Frequencies (slope in Blamp mode)	1,500 Hz (24 dB/octave)	1,500 Hz (24 dB/octave)	1,200 Hz	1,500 Hz (24 dB/octave)	1,200 Hz (24 dB/octave)	100 Hz (24 dB/octave)	100 Hz (24 dB/octave)
Nominal Impedance (Blamp mode)	8 Ω (8 Ω/8 Ω)	8 Ω (8 Ω/8 Ω)	— (8 Ω/12 Ω)	4 Ω (4 Ω/8 Ω)	6 Ω (6 Ω/8 Ω)	8 Ω	4 Ω
Input Connections	2 Neutrik NL4	2 Neutrik NL4	2 Neutrik NL4	2 Neutrik NL4	2 Neutrik NL4	2 Neutrik NL4	2 Neutrik NL4
Dimensions (H x W at front x D)	266" x 15.35" x 14.6" (675 x 390 x 372 mm)	299" x 177" x 16.02" (759 x 450 x 407 mm)	488" x 18.4" x 19.09" (1,240 x 467 x 485 mm)	38.98" x 15.47" x 14.77" (990 x 393 x 375 mm)	15.5" x 39.0" x 14.9" (394 x 990 x 378 mm)	35.5" x 177" x 23.6" (902 x 450 x 600 mm)	39.96" x 22.05" x 23.7" (1,015 x 560 x 602 mm)
Net Weight	57.3 lb (26.0 kg)	71 lb (32.0 kg)	103.6 lb (47 kg)	80 lb (36.5 kg)	84 lb (38 kg)	105 lb (47.5 kg)	150 lb (68 kg)

¹ Half space



Tour X

Tour X brings the engineering excellence and aesthetic design of EV's world-class tour systems to an innovative and exciting series of portable loudspeakers. Combining bold design and breakthrough performance, the Tour X series is optimized for applications, such as club sound, pro music and concert sound. The line's full-range loudspeakers and monitors utilize either 1.25" DH3/2010A or 2" ND2 compression drivers, protected by an advanced fourth-order crossover. Rotatable

Constant Directivity waveguides provide coverage-pattern flexibility while 12" or 15" SMX woofers deliver high power-handling with high sensitivity. Tour X 18" subwoofers, meanwhile, use high-excursion EVS-18S LF transducers to ensure plenty of impact with ultra-low distortion. For tour-class performance in a portable package that's surprisingly affordable, look no further than Tour X.

TX1122 12" TWO-WAY FULL-RANGE LOUDSPEAKER



- High-quality sound at high levels
- Excellent pattern control for short-to-medium throw
- Low-distortion SMX2120 woofer with fully symmetric drive
- 1.25" DH3/2010A titanium HF compression driver
- 90° H x 50° V Constant Directivity waveguide
- Advanced fourth-order crossover with HF protection
- 97 dB sensitivity, 130 dB maximum SPL
- Power handling: 500 W continuous, 2000 W peak
- Lightweight trapezoidal plywood/MDF enclosure
- Pole mount for use with subwoofer or stand
- Six 3/8" threaded suspension points
- Black EVCoat finish

TX1152 15" TWO-WAY FULL-RANGE LOUDSPEAKER



- High-output, high-quality sound
- Excellent pattern control for medium throw use
- Low-distortion SMX2151 woofer with fully symmetric drive
- 1.25" DH3/2010A titanium HF compression driver
- 60° x 40° rotatable Constant Directivity waveguide
- Advanced fourth-order crossover with HF protection
- 100 dB sensitivity, 133 dB maximum SPL
- Power handling: 500 W continuous, 2000 W peak
- Lightweight trapezoidal plywood/MDF enclosure
- Pole mount for use with subwoofer or stand
- Six 3/8" threaded suspension points
- Black EVCoat finish

TX2152 DUAL 15" TWO-WAY FULL-RANGE LOUDSPEAKER



- Very high SPL with smooth response
- Ideal as mains for small-to-medium clubs
- Excellent pattern control for medium throw use
- Dual SMX2151 woofers with fully symmetric drive
- 2" ND2 neodymium HF compression driver
- 60° x 40° rotatable Constant Directivity waveguide
- Advanced 6th-order crossover with HF protection
- 103 dB sensitivity, 139 dB maximum SPL
- Power handling: 1000 W continuous, 4000 W peak
- Internally braced trapezoidal plywood/MDF enclosure
- Six 3/8" threaded suspension points
- Black EVCoat finish

TX1181 18" SUBWOOFER



- High-power LF supplement to TX1122 and TX1152
- High-excursion EVS-18S woofer
- 6 dB/octave low-pass filter for parallel connection without added amp
- 100 dB sensitivity, 132 dB maximum SPL
- Power handling: 500 W continuous, 2000 W peak
- Top-side socket for speaker pole
- Six mount points for optional wheel kit
- Braced plywood/MDF enclosure
- Black EVCoat finish

TX2181 DUAL 18" SUBWOOFER



- High-power LF supplement to TX2152
- Low-distortion port design
- Two high-excursion EVS-18S woofers
- Use with processor and dedicated amp channel
- 103 dB sensitivity, 138 dB maximum SPL
- Power handling: 1000 W continuous, 4000 W peak
- Six mount points for optional wheel kit
- Braced plywood/MDF enclosure
- Black EVCoat finish

See page 35 for Tour X Floor Monitors.

	TX1122	TX1152	TX2152	TX1181	TX2181
Speaker Type	Full-range	Full-range	Full-range	Subwoofer	Subwoofer
Frequency Response (-3 dB)	60 Hz – 20 kHz	55 Hz – 20 kHz	55 Hz – 13 kHz	50–160 Hz	50–160 Hz
Frequency Range (-10 dB)	45 Hz – 20 kHz	40 Hz – 20 kHz	50 Hz – 18 kHz	45–700 Hz	40 Hz – 1.5 kHz
Sensitivity (SPL, 1 W/1 m)	97 dB	100 dB	103 dB	100 dB	103 dB
Max. SPL/1 m (calc)	130 dB	133 dB	139 dB	132 dB	138 dB
System Power Handling (Continuous, Peak)	500, 2000 W	500, 2000 W	1000, 4000 W	500, 2000 W	1000, 4000 W
Coverage(Nominal -6 dB)	90° H x 50° V	60° x 40° rotatable	60° x 40° rotatable		
LF Transducer	12" SMX2120	15" SMX2151	Two 15" SMX2151	18" EVS-18S	Two 18" EVS-18S
HF Transducer	1.25" DH3/2010A	1.25" DH3/2010A	2" ND2		
Internal Crossover	Yes	Yes	Yes	Low-pass filter	No
Crossover Frequency	1,750 Hz	1,650 Hz	1,750 Hz		
Nominal Impedance (Passive)	8 Ω	8 Ω	4 Ω	8 Ω	4 Ω
Minimum Impedance	5.4 Ω	5.6 Ω	3.1 Ω	7.5 Ω	2.9 Ω
Input Connections	Parallel Neutrik NL4	Parallel Neutrik NL4	Parallel Neutrik NL4	Parallel Neutrik NL4	Parallel Neutrik NL4
Enclosure Material	Plywood and MDF with EVCoat	Plywood and MDF with EVCoat	Plywood and MDF with EVCoat	Plywood and MDF with EVCoat	Plywood and MDF with EVCoat
Flying Suspension	Six 3/8" threaded inserts	Six 3/8" threaded inserts	Six 3/8" threaded inserts		
Dimensions (H x W x D)	24.25" x 15.04" x 14.96" (616 x 382 x 380 mm)	30.55" x 17.56" x 17.56" (776 x 446 x 446 mm)	45.43" x 20" x 18.54" in (1154 x 508 x 471 mm)	30.28" x 17.28" x 23.27" (769 x 439 x 591 mm)	45.43" x 20" x 27.2" (1154 x 508 x 691 mm)
Net Weight	44.53 lb (20.2 kg)	61.29 lb (27.8 kg)	94.36 lb (42.8 kg)	74.52 lb (33.8 kg)	123.68 lb (56.1 kg)



ETX Powered Loudspeakers

The ETX Powered Loudspeaker family builds upon the industry-leading innovation and 85-year heritage of Electro-Voice audio engineering to offer the most advanced professional-grade products for an array of applications.

A versatile high-end choice for live entertainment venues, rental companies, pro musicians and DJs, and installed sound, the family offers technologies from EV concert/touring systems. Three two-way models, a three-way model and two subs are available.

The ETX Powered Loudspeaker family extends the award-winning industrial design introduced by Electro-Voice in 2013. Inside each low-profile, tour-grade wood enclosure are a range of unique new features that set the family apart, combining intelligent technology and innovative industrial design for spectacular results across all applications. EV-engineered high-efficiency transducers and high-powered Class-D amplifiers, Signal Synchronized Transducers (SST) waveguide design and smart FIR-Drive DSP all work together to provide peerless EV sound quality and precise coverage at the highest SPLs. Designed, engineered, tested and assembled for ultimate reliability by Electro-Voice.

ETX-10P 10" TWO-WAY POWERED



- 10" LF SMX woofer
- 1.25" HF titanium compression driver
- 2000 W Class-D power amplifier with integrated FIR-Drive DSP
- 134 dB peak SPL

ETX-12P 12" TWO-WAY POWERED



- 12" LF SMX woofer
- 1.25" HF titanium compression driver
- 2000 W Class-D power amplifier with integrated FIR-Drive DSP
- 135 dB peak SPL

ETX-15P 15" TWO-WAY POWERED



- 15" LF SMX woofer
- 1.25" HF titanium compression driver
- 2000 W Class-D power amplifier with integrated FIR-Drive DSP
- 135 dB peak SPL

ETX-35P 15" THREE-WAY POWERED



- 15" LF SMX woofer
- 6.5" MF driver
- 1.25" HF titanium compression driver
- 2000 W Class-D power amplifier with integrated FIR-Drive DSP
- 136 dB peak SPL

ETX-15SP 15" POWERED SUBWOOFER



- 15" DVX woofer for maximum punch
- 1800 W Class-D power amplifier with integrated FIR-Drive DSP
- 134 dB peak SPL
- Special DSP preset for true cardioid performance across the full operating bandwidth

- Combo pole cup (insert and threaded) for use with full-range models
- Removable casters

ETX-18SP 18" POWERED SUBWOOFER



- 18" DVX woofer for maximum punch
- 1800 W Class-D power amplifier with integrated FIR-Drive DSP
- 135 dB peak SPL
- Special DSP preset for true cardioid performance across the full operating bandwidth

- Combo pole cup (insert and threaded) for use with full-range models
- Removable casters

INTELLIGENT TECHNOLOGY, INNOVATIVE DESIGN

- EV's FIR-Drive utilizes the latest Finite Impulse Response (FIR) filter technology to optimize transducer linearity. Advanced limiter algorithms for independent peak and thermal transducer protection.
- Complete full-function DSP control via a single-knob interface. LCD screen for easy system set-up and monitoring: location/application EQ presets (e.g. tripod, mounted, suspended, live, music, speech), limiter status, input level controls/meters and master volume control to ensure optimal gain structure. Parametric EQ allows for more precise configuration. Subs feature a preset for true cardioid performance.
- EV-patented Signal Synchronized Transducers (SST) waveguide design provides precise and consistent coverage across all system configurations. Waveguides are custom-designed and optimized per model.

SUPERIOR POWER AND PERFORMANCE

- State-of-the-art components deliver the legendary EV sound quality and reliability the pros trust: 1800 W (subs) and 2000 W (full-range) Class-D power amplifiers with integrated DSP produce high SPLs utilizing high-sensitivity, low-distortion transducers (including DVX and SMX series woofers and precision DH3-B HF titanium compression drivers).
- Lightweight, ergonomic, durable and compact 18-mm, 13-ply birch plywood enclosures finished with EVCoat. Eight mounting points for permanent installations (full-range models). Custom die-cast aluminum pole cups, handles and hardware.



See page 61–62 for ETX Accessories.

	ETX-10P	ETX-12P	ETX-15P	ETX-35P	ETX-15SP	ETX-18SP
Speaker Type	Two-way	Two-way	Two-way	Three-way	Subwoofer	Subwoofer
Frequency Response (-3 dB)	85 Hz – 20 kHz ¹	55 Hz – 20 kHz ¹	48 Hz – 20 kHz ¹	48 Hz – 20 kHz ¹	37–150 Hz ²	33–150 Hz ²
Frequency Range (-10 dB)	65 Hz – 20 kHz ¹	43 Hz – 20 kHz ¹	40 Hz – 20 kHz ¹	38 Hz – 20 kHz ¹	32–180 Hz ²	28–180 Hz ²
Maximum SPL	134 dB peak ³	135 dB peak ³	135 dB peak ³	136 dB peak ³	134 dB peak ³	135 dB peak ³
Low Pass Frequency					Adjustable: 80 Hz, 100 Hz, 120 Hz, 150 Hz	
Coverage (H x V)	90° x 60°	90° x 60°	90° x 60°	60° x 40°		
Power Rating	2000 W	2000 W	2000 W	2000 W	1800 W	1800 W
LF Transducer	10" SMX2100	12" SMX2120	15" SMX2150	15" SMX2151	15" DVX3159A	18" DVX3180A
MB Transducer				6.5" EVS-6C		
HF Transducer	1.25" DH3-B	1.25" DH3-B	1.25" DH3-B	1.25" DH3-B		
Crossover Frequency	1700 Hz	1600 Hz	1500 Hz	700 Hz, 2900 Hz		
Power Consumption				100–240 V~, 50–60 Hz, 1.6–0.8 A ⁴		
Connectors	Two XLR/TRS combo jack and one XLR link output		Two XLR/TRS combo jacks and two XLR link output			
Enclosure	18 mm, 13-ply birch plywood with EVCoat					
Grille	16 AWG steel with powdercoat					
Suspension	Eight M10 suspension points					
Dimensions (H x W x D)	21" x 13" x 14" (526 x 330 x 365 mm)	24" x 15" x 16" (613 x 381 x 400 mm)	27" x 17" x 18" (691 x 431 x 447 mm)	40" x 18" x 17" (1023 x 469 x 426 mm)	19" x 23" x 27" (471 x 576 x 692 mm)	22" x 27" x 31" (550 x 675 x 777 mm)
Dimensions (H x W x D) with casters					19" x 23" x 32" (471 x 576 x 825 mm)	22" x 27" x 36" (550 x 675 x 910 mm)
Net Weight	44.8 lb (20.3 kg)	52.0 lb (23.6 kg)	61.1 lb (27.7 kg)	84.2 lb (38.2 kg)	91.9 lb (41.7 kg)	114.2 lb (51.8 kg)

¹ Full space measurement using the music DSP preset.

² Half space measurement using the music DSP preset and 150 Hz low pass.

³ Maximum SPL is measured at 1 m using broadband pink noise at maximum output.

⁴ Current rating is 1/8 power.

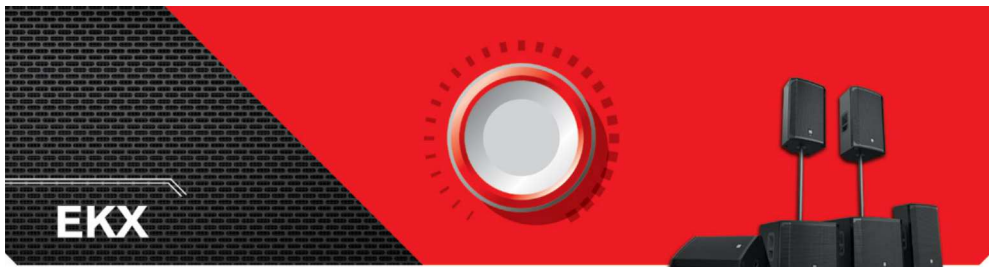

The EKX series combines legendary EV sound quality and reliability with the latest technology — all in a compact package suitable for a wide range of sound reinforcement scenarios, including musicians/DJs and live/club/installed sound applications. The EKX series features eight models (four powered and four passive), including 12" and 15" two-way models and 15" and 18" subwoofers. EKX is positioned above the ZLX and ELX series and below the ETX series.

Innovative, EV-exclusive features ensure EKX provides best-in-class performance and versatility, including EV-engineered speaker and amplifier components for superior sound quality and reliability, and on-board signal processing with user-friendly single-knob control and application presets for easy set-up. EV's award-winning industrial design — incorporating robust wood enclosures, premium-quality hardware, and durable EVCoat finish — ensures that EKX speakers look as great as they sound.

LOUDSPEAKERS

CONCERT

INSTALL

PORTABLE PA

LOUDSPEAKERS

CONCERT

INSTALL

PORTABLE PA

EKX-12P 12" TWO-WAY POWERED



- QuickSmartDSP features best-in-class processing, EV's signature single-knob user interface, and intuitive menu navigation via LCD.
- High-efficiency 1500 W Class D power amplifier delivers up to 132 dB peak SPL via high-sensitivity transducers designed and engineered by EV.
- EV-patented Signal Synchronized Transducers™ (SST) waveguide design provides precise and consistent coverage.
- Lightweight, compact 15-mm wood enclosure with internal bracing, durable EVCoat finish, eight M10 threaded mounting points, aluminum pole mounts, and all-metal handles.

EKX-12 12" TWO-WAY PASSIVE



- 1400 W (peak), 131 dB SPL utilizing high-sensitivity transducers designed and engineered by EV.
- EV-patented Signal Synchronized Transducers™ (SST) waveguide design provides precise and consistent coverage.
- Lightweight, compact 15-mm wood enclosure with internal bracing, and durable EVCoat finish.
- Eight M10 threaded mounting points, aluminum pole mounts, and all-metal handles.
- 90° x 60° pattern for best coverage on mid-size stages. 40° monitor angle with rubber feet.

EKX-15P 15" TWO-WAY POWERED



- QuickSmartDSP features best-in-class processing, EV's signature single-knob user interface, and intuitive menu navigation via LCD.
- High-efficiency 1500 W Class D power amplifier delivers up to 134 dB peak SPL via high-sensitivity transducers designed and engineered by EV.
- EV-patented Signal Synchronized Transducers™ (SST) waveguide design provides precise and consistent coverage.
- Lightweight, compact 15-mm wood enclosure with internal bracing, durable EVCoat finish, eight M10 threaded mounting points, aluminum pole mounts, and all-metal handles.

EKX-15 15" TWO-WAY PASSIVE



- 1600 W (peak), 132 dB SPL utilizing high-sensitivity transducers designed and engineered by EV.
- EV-patented Signal Synchronized Transducers™ (SST) waveguide design provides precise and consistent coverage.
- Lightweight, compact 15-mm wood enclosure with internal bracing, and durable EVCoat finish.
- Eight M10 threaded mounting points, aluminum pole mounts, and all-metal handles.
- 90° x 60° pattern for best coverage on mid-size stages. 40° monitor angle with rubber feet.

EKX-15SP 15" POWERED SUBWOOFER



- QuickSmartDSP features best-in-class processing, EV's signature single-knob user interface, and intuitive menu navigation via LCD.
- Cardioid Control Technology allows output to be steered towards the audience with up to 35dB reduction on stage with multiple subs are deployed.
- High-efficiency 1300 W Class D power amplifier delivers up to 133 dB peak SPL utilizing high-sensitivity transducers designed and engineered by EV.
- Large slot ports for low distortion and excellent bass extension. Metal grille reinforcement bar. M20 threaded pole mount plate.

EKX-15S 15" PASSIVE SUBWOOFER



- 1600 W (peak), 133 dB SPL on utilizing high-sensitivity transducers designed and engineered by EV.
- Lightweight, compact 15-mm wood enclosure with internal bracing, and durable EVCoat finish.
- Large slot ports for low distortion and excellent bass extension.
- Metal grille reinforcement bar.
- M20 threaded pole mount plate.

EKX-18SP 18" POWERED SUBWOOFER



- QuickSmartDSP features best-in-class processing, EV's signature single-knob user interface, and intuitive menu navigation via LCD.
- Cardioid Control Technology allows output to be steered towards the audience with up to 35dB reduction on stage with multiple subs are deployed.
- High-efficiency 1300 W Class D power amplifier delivers up to 134 dB peak SPL utilizing high-sensitivity transducers designed and engineered by EV.
- Large slot ports for low distortion and excellent bass extension. Two Metal grille reinforcement bars. M20 threaded pole mount plate.

EKX-18S 18" PASSIVE SUBWOOFER



- 1600 W (peak), 134 dB SPL utilizing high-sensitivity transducers designed and engineered by EV.
- Lightweight, compact 15-mm wood enclosure with internal bracing, and durable EVCoat finish.
- Large slot ports for low distortion and excellent bass extension.
- Two metal grille reinforcement bars.
- M20 threaded pole mount plate.

	EKX-12P	EKX-15P	EKX-15SP	EKX-18SP	EKX-12	EKX-15	EKX-15S	EKX-18S
Speaker Type	Two-way	Two-way	Subwoofer	Subwoofer	Two-way	Two-way	Subwoofer	Subwoofer
Frequency Response (-3 dB)	60 Hz–18 kHz ¹	55 Hz–18 kHz ¹	45 Hz–150 kHz ²	40 Hz–150 kHz ²	82Hz–18 kHz ¹	75 Hz–18 kHz ¹	60 Hz–100 kHz ¹	50 Hz–100 kHz ¹
Frequency Range (-10 dB)	50 Hz–20 kHz ¹	48 Hz–20 kHz ¹	40 Hz–180 kHz ²	35 Hz–180 kHz ²	65 Hz–20 kHz ¹	50 Hz–20 kHz ¹	40 Hz–300 kHz ¹	35 Hz–300 kHz ¹
Axial Sensitivity					95 dB ¹	96 dB ¹	95 dB ¹	96 dB ¹
Maximum SPL	132 dB ²	134 dB ²	133 dB peak ²	134 dB peak ²	131 dB peak ²	132 dB peak ²	133 dB peak ²	134 dB peak ²
Rec. High-Pass Frequency					55 Hz	50 Hz	35 Hz	30 Hz
Coverage (H x V)		90° x 60°			90° x 60°			
Power Handling					350 W continuous 1400 W peak	400 W continuous 1600 W peak	400 W continuous 1600 W peak	
Power Rating		1500 W		1300 W				
LF Transducers	EVS-12M 300mm (12 in.)	EVS-15M 381mm (15 in.)	EVS-15C 381 mm (15 in.)	EVS-18C 457 mm (18 in.)	EVS-12M 300mm (12 in.)	EVS-15M 381mm (15 in.)	EVS-15C 381 mm (15 in.)	EVS-18C 457 mm (18 in.)
HF Transducer		DH-1M 1-inch titanium compression driver				DH-1M 1-inch titanium compression driver		
Low Pass Frequency			Adjustable: 80 Hz, 100 Hz, 120 Hz, 150 Hz					
Crossover Frequency		1.7 kHz				1.6 kHz		
Nominal Impedance							8 Ohms	
Minimum Impedance					7.5 Ohms	7.2 Ohms	7.5 Ohms	7.0 Ohms
Connectors	(1) Stereo RCA input, (2) XLR/TRS combo jack, and (1) XLR link output		(2) XLR/TRS combo jacks and (2) XLR link outputs				Dual NL4	
Enclosure	15 mm, plywood with EVCoat							
Grille	18 AWG steel with powdercoat							
Suspension	(8) M10 threaded mounting points				(8) M10 threaded mounting points			
Dimensions (H x W x D)	24" x 15" x 14" (607 x 375 x 356 mm)	27" x 17" x 17" (685 x 432 x 429 mm)	18" x 21" x 22" (455 x 530 x 551 mm)	20" x 24" x 24" (520 x 606 x 612 mm)	24" x 15" x 14" (607 x 375 x 356 mm)	27" x 17" x 17" (685 x 432 x 429 mm)	18" x 21" x 22" (455 x 530 x 551 mm)	20" x 24" x 24" (520 x 606 x 612 mm)
Net Weight	18.8 kg (41.4 lb)	24.4 kg (53.9 lb)	26.2 kg (57.7 lb)	32.8 kg (72.4 lb)	17.4 kg (38.3 lb)	23.2 kg (51.2 lb)	24.9 kg (55.0 lb)	31.8 kg (70.0 lb)
Shipping Weight	22.9 kg (50.4 lb)	29.5 kg (65.0 lb)	32.6 kg (71.8 lb)	41.2 kg (90.0 lb)	21.4 kg (47.2 lb)	28.2 kg (62.4 lb)	31.3 kg (69.0 lb)	40.1 kg (88.4 lb)
Power Consumption	1.8 A ³							

See page 62 for EKX Accessories.

¹ Full space measurement.

² Maximum SPL is measured at 1 m using broadband pink noise at rated peak power rating.

³ Current rating is 1/3 power.



Live X

Clear, powerful and musical, the Live X series was born to command the stage for professional music performance. Available in both powered and passive versions, Live X loudspeakers offer top-quality components in remarkably affordable configurations that put the EV-quality experience within reach for artists, engineers and live-sound businesses. Designed for a wide range of portable sound applications, Live X loudspeakers are housed in

hardy stackable enclosures of solid wood, making them lighter than comparable-quality composite or plastic boxes and therefore easier to load, transport and set up. With high output, extended frequency range and high sensitivity, Live X loudspeakers are clean, flat and hot, making music of all kinds sound its best. The Live X series is serious gear for serious sound.

ELX112P POWERED 12" TWO-WAY FULL-RANGE



- ELX112 performance with self-amplification
- 50 Hz – 20 kHz frequency range
- Lightweight, cool-running 1000 W Class D amp
- Biamped with 24 dB/octave crossover
- Transducer protection
- Bypassable high-pass for external subwoofer
- XLR, TRS and RCA connections
- Versatile gain, mixing and processing controls
- Pre- or post-mix parallel outputs

ELX112 12" TWO-WAY FULL-RANGE



- Compact power for sound reinforcement and stage monitoring
- EVS-12K woofer
- 1.5" DH-1K titanium HF compression driver
- 55 Hz – 20 kHz frequency range
- 90° x 50° coverage-pattern waveguide
- 60° monitor angle
- 132 dB maximum SPL
- Power handling: 250 W continuous, 1000 W peak
- Braced 15 mm plywood enclosure
- Pole mount or stack with Live X subwoofers
- Black textured finish

ELX115P POWERED 15" TWO-WAY FULL-RANGE



- ELX115 performance with self-amplification
- 44 Hz – 20 kHz frequency range
- Lightweight, cool-running 1000 W Class D amp
- Biamped with 24 dB/octave crossover
- Transducer protection
- Bypassable high-pass for external subwoofer
- XLR, TRS and RCA input connections
- Versatile gain, mixing and processing controls
- Pre- or post-mix parallel outputs

ELX115 15" TWO-WAY FULL-RANGE



- More power, fuller sound for larger rooms
- EVS-15K woofer
- 1.5" DH-1K titanium HF compression driver
- 50 Hz – 20 kHz frequency range
- 90° x 50° coverage-pattern waveguide
- 60° monitor angle
- 134 dB maximum SPL
- Power handling: 400 W continuous, 1600 W peak
- Braced 15 mm plywood enclosure
- Pole mount or stack with Live X subwoofers
- Black textured finish

ELX118P POWERED 18" SUBWOOFER



- ELX118 performance with self-amplification
- EVS-18K woofer for extended LF
- 32 Hz – 130 Hz frequency range
- Lightweight, cool-running 700 W Class D amp
- Selectable normal/boost modes
- XLR and TRS combo input
- XLR parallel output

ELX118 18" SUBWOOFER



- Supplemental bass for ELX112 or ELX115
- EVS-18K woofer for extended LF
- 35 Hz – 200 Hz frequency range
- 134 dB maximum SPL
- Power handling: 400 W continuous, 1600 W peak
- Braced 15 mm plywood enclosure
- Stack or pole-mount full-range boxes
- Black textured finish



ELX215 DUAL 15" TWO-WAY FULL-RANGE



- High-volume punch and ultra-wide frequency response
- Ideal for mains
- Two EVS-15K woofers for extended LF
- 1.5" DH-1K titanium HF compression driver
- 38 Hz – 20 kHz frequency range
- 90° x 50° coverage-pattern waveguide
- 137 dB maximum SPL
- Power handling: 600 W continuous, 2400 W peak
- Braced 15 mm plywood enclosure
- Black textured finish

See page 61 for Live X Covers.

	ELX112P	ELX115P	ELX118P	ELX112	ELX115	ELX118	ELX215
Speaker Type	Full-range, two-way, wedges	Full-range, mid-high, two-way	Subwoofer	Full-range, two-way, wedges	Full-range, mid-high, two-way	Subwoofer	Full-range, mid-high, two-way
Frequency Response (-3 dB)	60 Hz – 18 kHz	56 Hz – 18 kHz	42–100 Hz	82 Hz – 18 kHz	75 Hz – 18 kHz	50–100 Hz	62 Hz – 18 kHz
Frequency Range (-10 dB)	50 Hz – 20 kHz	44 Hz – 20 kHz	32–130 Hz	55 Hz – 20 kHz	50 Hz – 20 kHz	35–200 Hz	38 Hz – 20 kHz
Axial Sensitivity (SPL, 1 W/1 m)				94 dB	95 dB	96 dB	96 dB
Max. SPL/1m (calc)	132 dB	134 dB	134 dB	132 dB Half Space	134 dB Half Space	134 dB	137 dB
Recommended High-pass Frequency				45 Hz	40 Hz	30 Hz	35 Hz
System Power Handling (Continuous, Program, Peak)				250 W Continuous 1000 W Peak	400 W Continuous 1600 W Peak		600 W Continuous 2400 W Peak
Coverage (Nominal -6 dB) H x V	90° x 50°	90° x 50°	Omnidirectional	90° x 50°	90° x 50°	Omnidirectional	90° x 50°
Power Rating	1000 W	1000 W	700 W				
LF Transducer	12" EVS-12K woofer	15" EVS-15K woofer	18" EVS-18K woofer	12" EVS-12K woofer	15" EVS-15K woofer	18" EVS-18K woofer	15" EVS-15K woofer
HF Transducer	DH-1K	DH-1K		DH-1K	DH-1K		DH-1K
Internal Crossover	Yes	Yes	Yes	Yes	Yes	Yes	Yes
Nominal Impedance (Passive)	8 Ω	8 Ω	8 Ω	8 Ω	8 Ω	8 Ω	4 Ω
Input Connections	XLR, TRS & RCA	XLR, TRS & RCA	XLR, TRS & RCA	Parallel Neutrik NL4	Parallel Neutrik NL4	Parallel Neutrik NL4	Parallel Neutrik NL4
Woofer Size	12" (304.8 mm)	15" (381 mm)	18" (457.2 mm)	12" (304.8 mm)	15" (381 mm)	18" (457.2 mm)	15" (381 mm)
Dimensions (H x W x D)	23.9" x 14.25" x 13.39" (607 x 362 x 340 mm)	27.87" x 17.01" x 15.04" (708 x 432 x 382 mm)	26.02" x 19.96" x 22.6" (661 x 507 x 574 mm)	23.9" x 14.25" x 13.39" (607 x 362 x 340 mm)	27.87" x 17.01" x 15.04" (708 x 432 x 382 mm)	26.02" x 19.96" x 22.6" (661 x 507 x 574 mm)	45.43" x 17.01" x 19.72" (1154 x 432 x 501 mm)
Net Weight	37.04 lb (16.8 kg)	49.6 lb (22.5 kg)	69 lb (31.3 kg)	35.27 lb (16.0 kg)	48.28 lb (21.9 kg)	67.46 lb (30.6 kg)	89.73 lb (40.7 kg)



ZLX

Electro-Voice condenses decades of proven pro audio engineering know-how into ZLX, its next generation of high-performance portable loudspeakers. Available in powered and passive 12" and 15" two-way versions, ZLX was designed with a singular goal: to deliver best-in-class performance across every detail. No other comparably priced loudspeaker sounds better or gives you more control over your sound. ZLX powered models match the legendary

quality of EV-engineered drivers with a custom-built 1000 W Class-D amplifier module and feature an LCD display and innovative single-knob DSP control with presets so you can quickly optimize loudspeaker performance according to your performance style and space. Whether used as mains or monitors, ZLX will enhance your gig with incredible sonic impact and intelligibility – the renowned "EV Sound" the pros trust.

ZLX-12P 12" TWO-WAY POWERED LOUDSPEAKER



- Compact and lightweight
- Standout choice for sound reinforcement or stage-monitoring
- 12" woofer for low-end punch in a compact enclosure
- LCD display and one-knob DSP control with presets for precise, speedy set up
- Input level meters and independent amplifier control to ensure optimal gain structure
- Front LED for "power on" and "limit" indication
- 1.5" high-frequency titanium compression driver
- Durable composite construction with innovative hi/lo grip design for easy pole mounting
- Patented split-baffle design for superior drive time alignment
- 1000 W Class-D amplifier
- 126 dB maximum SPL
- 50 Hz – 20 kHz frequency range

ZLX-15P 15" TWO-WAY POWERED LOUDSPEAKER



- Crisp clean highs and tight, deep lows for larger spaces
- 15" woofer for extended low frequency response
- LCD display and one-knob DSP control with presets for precise, speedy set up
- Input level meters and independent amplifier control to ensure optimal gain structure
- Front LED for "power on" and "limit" indication
- 1.5" high-frequency titanium compression driver
- Durable composite construction with innovative hi/lo grip design for easy pole mounting
- Patented split-baffle design for superior drive time alignment
- 1000 W Class-D amplifier
- 127 dB maximum SPL
- 42 Hz – 20 kHz frequency range

LCD DISPLAY AND SINGLE-KNOB DSP CONTROL

VISUAL CONTROL AND MONITORING WITH PRESETS

In the case of the ZLX's uncluttered control panel, less really does mean more. Though the multiple dials and switches on other powered loudspeakers may suggest more functionality, ZLX's powerful DSP engine is accessed by a clean single-knob design with LCD display, and actually offers the most precise control and configuration available at its price point. Use the presets to optimize ZLX according to your application (music, live, speech, club) and your location (pole mount, monitor, install) and hear the difference in seconds. Smart design, straightforward operation.



ZLX-12 12" TWO-WAY PASSIVE LOUDSPEAKER



- 12" woofer for low-end punch in a compact enclosure
- 1.5" high-frequency titanium compression driver
- Durable composite construction with innovative hi/lo grip design for easy pole mounting
- Patented split-baffle design for superior drive time alignment
- 55 Hz – 20 kHz frequency range
- 250 W continuous and 1000 W peak power handling
- 95 dB SPL sensitivity; 125 dB maximum SPL

ZLX-15 15" TWO-WAY PASSIVE LOUDSPEAKER



- 15" woofer for extended low frequency response
- 1.5" high-frequency titanium compression driver
- Durable composite construction with innovative hi/lo grip design for easy pole mounting
- Patented split-baffle design for superior drive time alignment
- 44 Hz – 20 kHz frequency range
- 250 W continuous and 1000 W peak power handling
- 96 dB SPL sensitivity; 126 dB maximum SPL



See page 61 for ZLX Covers.

	ZLX-12P	ZLX-15P	ZLX-12	ZLX-15
Speaker Type	Two-way, powered	Two-way, powered	Two-way, passive	Two-way, passive
Frequency Response	65 Hz – 18 kHz ¹	55 Hz – 18 kHz ¹	82 Hz – 18 kHz ²	56 Hz – 18 kHz ²
Frequency Range	50 Hz – 20 kHz ²	42 Hz – 20 kHz ²	55 Hz – 20 kHz	44 Hz – 20 kHz
Axial Sensitivity			95 dB	96 dB
Max. Measured SPL	126 dB	127 dB	125 dB	126 dB
Recommended High-pass Frequency			40 Hz	40 Hz
Power Handling (Continuous, Peak)			250 W Continuous 1000 W Peak	250 W Continuous 1000 W Peak
Coverage (H x V)	90° x 60°	90° x 60°	90° x 60°	90° x 60°
Power Rating	1000 W	1000 W		
LF Transducer	12" EVS-12K woofer	15" EVS-15L woofer	12" EVS-12K woofer	15" EVS-15L woofer
HF Transducer	DH-1K	DH-1K	DH-1K	DH-1K
Crossover Frequency			2.1 kHz	1.7 kHz
Nominal Impedance			8 Ω	8 Ω
Minimum Impedance			7 Ω	7 Ω
Connectors	Two XLR/TRS combo jack, one 3.5 mm input and one XLR link output		Dual NL4	Dual NL4
Enclosure Material	Polypropylene	Polypropylene	Polypropylene	Polypropylene
Grille	18 ga steel with black powder coat	18 ga steel with black powder coat	18 ga steel with black powder coat	18 ga steel with black powder coat
Dimensions (H x W x D)	24" x 14" x 14" (610 x 356 x 356 mm)	27" x 17" x 15" (685 x 423 x 383 mm)	24" x 14" x 14" (610 x 356 x 356 mm)	27" x 17" x 15" (685 x 423 x 383 mm)
Net Weight	34.3 lb (15.6 kg)	38.0 lb (17.3 kg)	32.8 lb (14.9 kg)	36.5 lb (16.6 kg)

¹ Using MUSIC DSP preset.

² Full Space Measurement, will have low frequency extension when mount on floor or wall.

RIGGING AND ACCESSORIES

XLC215 and XLD B-1 GRID + XLC215 + AGCD + XLD LOUDSPEAKER

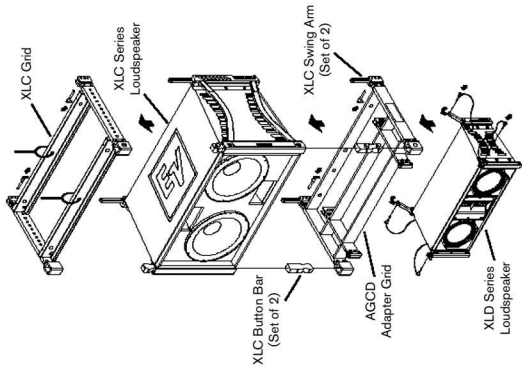

XLD281 XLD281 + CBEAM



Coupler Beam

XLD281 Enclosures

Front View

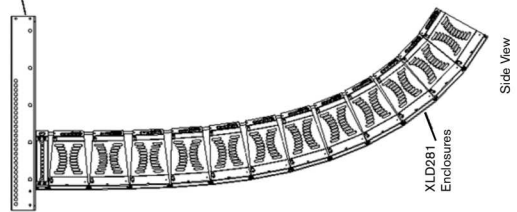

Side View

XLD281 XLD281 + DOLLY

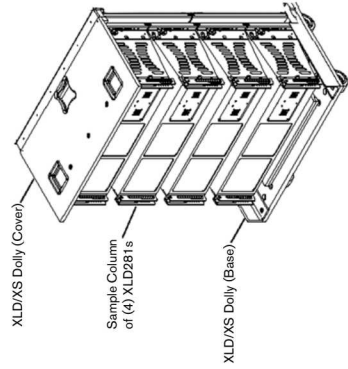

XLD/XS Dolly (Cover)

Sample Column of (4) XLD281s

XLD/XS Dolly (Base)

(One half of dolly shown in drawing)

XLC CONCERT/PORTABLE RIGGING

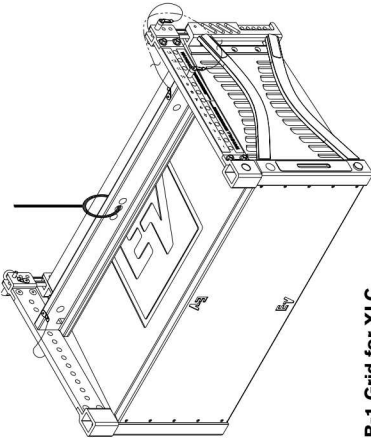

B-1 Grid for XLC
(other rigging hardware included with speaker)

XLCi INSTALL RIGGING

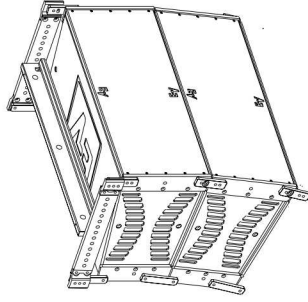

B-2 Grid for XLCi
(other rigging hardware included with speaker)

XLC and XLVC GROUND STACK KITS
XGS-3

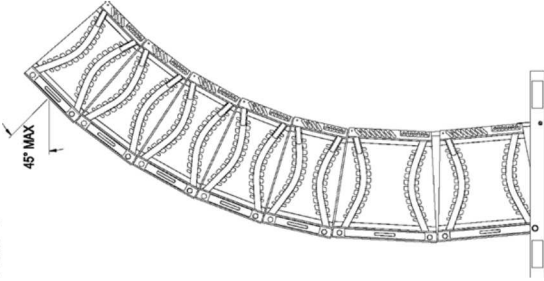

45° MAX

XGS-4

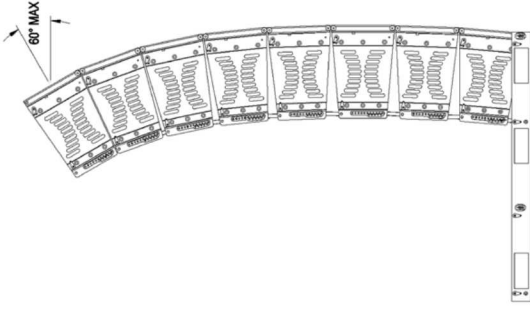

60° MAX

Xi-1082 UNDER BALCONY/ON-WALL MOUNT

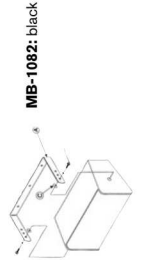

MB-1082: black

FRI-2082 UNDER BALCONY/ON-WALL MOUNT

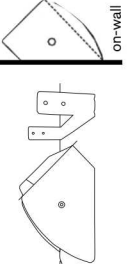

The 100° x 100° dispersion angle allows the FRI-2082 to be installed vertically on the wall as well. Mounting bracket comes with FRI-2082.

RIGGING AND ACCESSORIES

X-LINE ADVANCE

X12TC-GRID WITH PULL-BACK TO VENUE

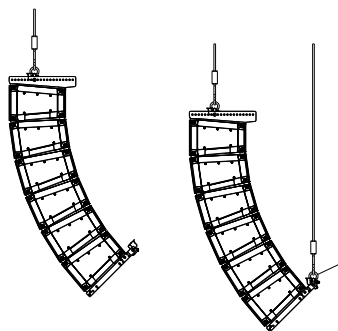

X12TE-GRID X12PU-BGK TO PULL-UP TO GRID

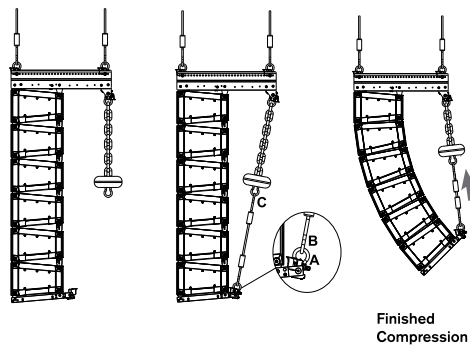

Finished Compression

X12TC-GRID COMPACT GRID

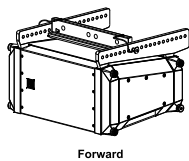

Forward

X12TC-GRID EXTENDED GRID

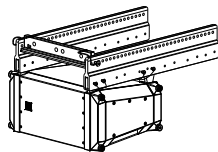

Single

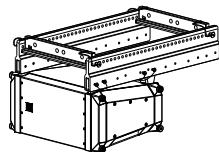

Double

X12TC-GRID PULL-UP KIT

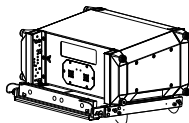
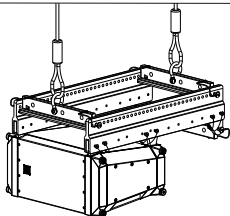

Pull-Up Kit Installed

X1/X2 GROUND STACK KITS

Dolly Top ground-stacking

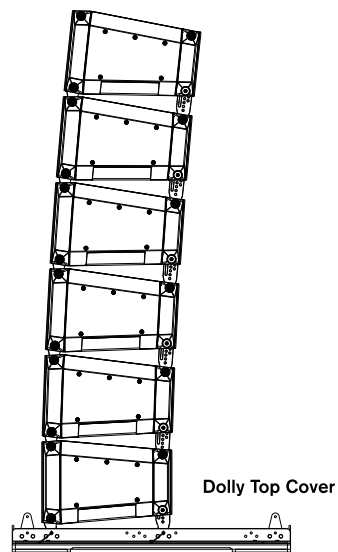

Dolly Top Cover

X12T-DOLLY

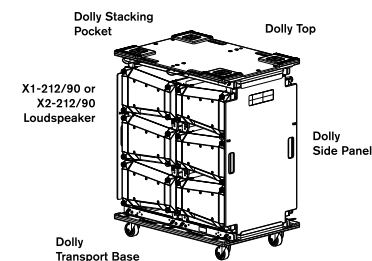

X1-212/90 or X2-212/90 Loudspeaker

Dolly Transport Base

Dolly Top

Dolly Side Panel

X12-128-DOLLY

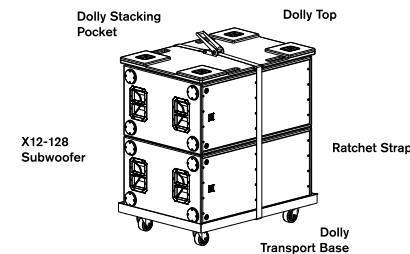

X12-128 Subwoofer

Dolly Transport Base

Dolly Top

Ratchet Strap



LOUDSPEAKERS
CONCERT
INSTALL
PORTABLE PA

LOUDSPEAKERS
CONCERT
INSTALL
PORTABLE PA

EV INNOVATION

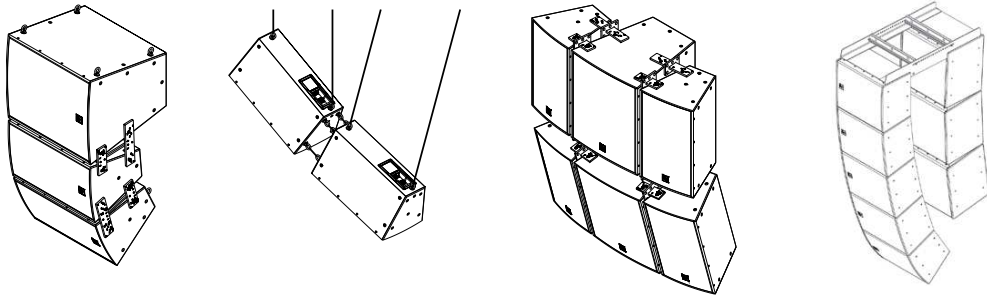

EVF and EVH Series

HRK AND VRK RIGGING KITS

VRK-1

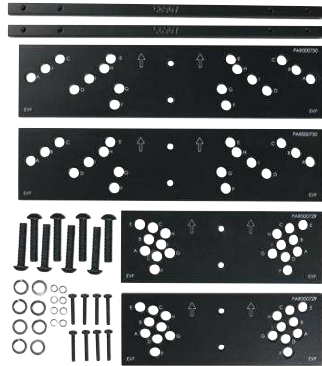

VRK-2

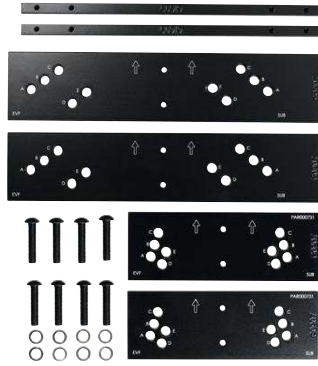

(HRK not shown)

EVA Rigging

EVA modules connect with an integrated internal top-to-bottom metal structure. Hidden by cover panels, this nearly invisible rigging system gives an EVA cluster the aesthetic appeal of an architectural element rather than a loudspeaker system. The rigging system is designed to carry an array with a safety factor of greater than 8:1.



EVA-SG2 (Standard Grid)

For typical tilt angles in 3 and 4 module arrays and pull-up applications in large arrays when extreme angles are required. Includes one spreader bar.



EVA-EG2 (Extended Grid)

For typical tilt angles in arrays taller than four modules, or extreme angles in arrays of four modules or less. Includes one spreader bar.

EVA-CG (Coupler Grid, not shown)

Connects full-range modules and single 15" subwoofers so that you can fly the subs without increasing trim height.

EVA, EVF AND EVH

GLAND NUT COVER PLATES



CDG
Dual gland nut cover plate



CDNL4
Dual NL4 cover plate



CSG
Single gland nut cover plate

EV INNOVATION ACCESSORIES

EVI-AC



ACCESS CARD

EV Innovation Access Card lets you test EVA, EVF or EVH transducers and protection circuitry without disassembling the cabinet.

EVU-TK60



TRANSFORMER KIT

60-Watt, 70.7/100-Volt input transformer for EVU systems, with multiple taps.

TK-150



TRANSFORMER KIT

70/100 V transformer kit for EVF and EVH.

EVU-CDNL4



COVER PLATE KIT

Dual NL4 cover plate for EVU series only.

EVI

EVI Series

EBK-1 (EYEBOLT KIT)

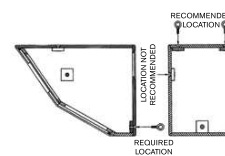

Contains three 3/8-16 forged shoulder bolts.

EVI-12

"U" STYLE BRACKET

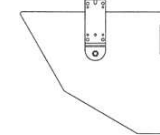

EVI-12MBB: black
EVI-12MBW: white

EVI-15

"U" STYLE BRACKET

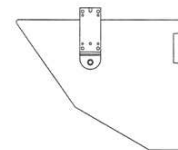

EVI-15MBB: black
EVI-15MBW: white

EVI-28

"U" STYLE BRACKET

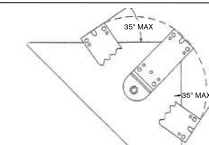

EVI-28MBB: black
EVI-28MBW: white
The radius of action is 140°.

EVID

EVID 3.2, EVID 4.2 or EVID 6.2 + AB-ZE



SPECIALTY LOUSPEAKERS

S-40 WALL, CEILING OR STAND MOUNT

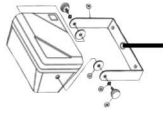

Note: The thread diameter can be reduced with a standard 5/8" screw adapter for different mic stands.

S-40 MB/B: black
S-40 MB/W: white

ETX, EKX, Live X, ZLX and ZXA1 Covers

Each cover is custom-fitted with access to handle



Sx300 and SB122

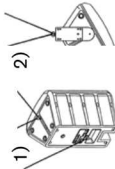

- 1) MB 100
- 2) MB 100 + MB 200

Security advice:
When flown by 90° (figure 2), do not use eyebolts only!

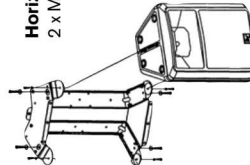

Horizontal Cluster 120° (2 systems)
2 x MB 200 + 1 x MB 300 necessary

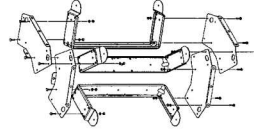

Horizontal Cluster 180° (3 systems)
3 x MB 200 + 2 x MB 300 necessary

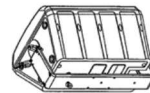

Wall or Ceiling-Mount
1 x MB 200 necessary

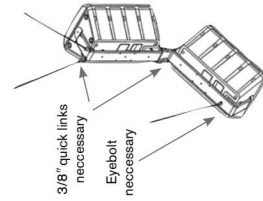

Vertical Cluster
2 x MB 200 necessary

ETX

ETX-BRKT ETX WALL MOUNT BRACKET

For 10", 12", and 15" models
Bracket sold separately

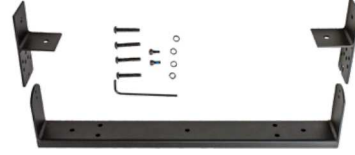

ETX-BRKT35

ARRAY BRACKET FOR ETX-35P



ETX-TCA-S

ETX TRUSS ADAPTOR

For 10" model



ETX-TCA-L

ETX TRUSS ADAPTOR

For 12", 15", and 35" models



ZX1

ZX1 + TCA-ZX1

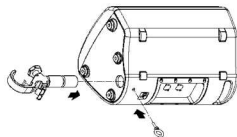

ZX1i + AB-ZE

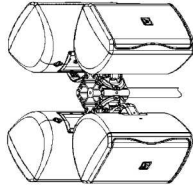

ZX1 + MPI1-B

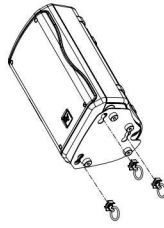

EKX

EKX-BRK

EKX WALL MOUNT BRACKET

For 12" and 15" models
Bracket sold separately



EKX-TCA

EKX WALL MOUNT BRACKET



ZX3 and ZX5

MB3 or MB5 WALL/CEILING MOUNT BRACKET



CB5

CLUSTER BRACKET KIT

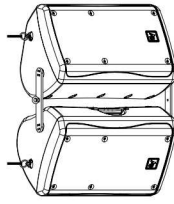

ZLX

ZLX-BRK

ZLX WALL MOUNT BRACKET

For all models
Bracket sold separately



VSA-1

VERTICAL STRONG-ARM MOUNT

VSA-1 using TSA-1



EBK-3

FORGED M8 EYEBOLT KIT



SSK-1

SINGLE-STUD RIGGING KIT

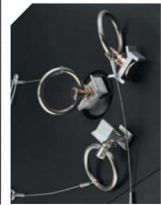

HA-3 or HA-5

HANDLE MOUNT ADAPTER

Handle adapter
to be used with VSA-1





Tour Grade

Designed for the most demanding applications in both touring and installed sound, EV's ultra-reliable Tour Grade amplifiers offer a unique combination of output power, sonic excellence and high efficiency, all in a compact, lightweight format that's ideal for life on the road. Based on grounded-bridge Class-H topology, Tour Grade amps feature an integrated switch-mode power supply for maximum power per pound, with plenty of headroom to

handle transient peaks and low loads. The optional RCM-26 remote control module adds state-of-the-art IRIS-Net-controlled DSP, including FIR-Drive loudspeaker optimization, IIR filters, signal routing, level control, dynamics and system supervision. The optional RCM-28 module provides additional DSP options as well as the revolutionary OMNEO Media Networking Architecture for the most demanding applications.

TG5 2000 W PER CHANNEL POWER AMPLIFIER



- High-level touring performance
- Rugged, lightweight package
- 2000 W per channel (2 Ω)
- Grounded-bridge Class-H design
- Switch-mode power supply
- Microprocessor-controlled
- Front LCD panel for operation-mode setup and monitoring
- Slot for optional RCM-26 or RCM-28 IRIS-Net-compatible DSP and control module
- 11-level protection package
- Only 31.4 lb (14.2 kg)

TG7 3500 W PER CHANNEL POWER AMPLIFIER



- High-power performance for top-level tours
- Rugged, lightweight package
- 3500 W per channel (2 Ω)
- Grounded-bridge Class-H design
- Switch-mode power supply
- Microprocessor-controlled
- Front LCD panel for operation-mode setup and monitoring
- Slot for optional RCM-26 or RCM-28 IRIS-Net-compatible DSP and control module
- 11-level protection package
- Only 32 lb (14.5 kg)

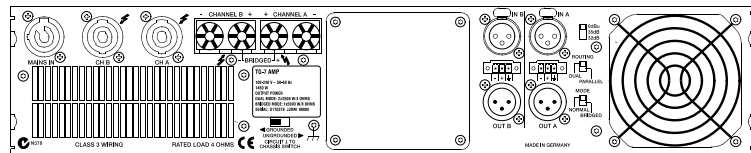

TG5 and TG7 rear view

UCC1



REMOTE CONTROL INTERFACE FOR IRIS-NET

- USB-CAN converter for IRIS-Net enabled devices
- Supports up to 100 CAN devices
- Parallel CAN connections on RJ-45 Ethercons
- USB-powered
- XLR jack for audio bus monitoring
- 19" rackmount panel included
- Status LED shows CAN activity and device status

RCM-28



IRIS-NET REMOTE CONTROL MODULE FOR TOUR GRADE AMPLIFIERS

- OMNEO Media Networking Architecture
- Advanced FIR-Drive loudspeaker optimization
- High precision load impedance supervision
- Two GPI and two GPO ports
- One-button system test for fast, complete check of connected cables and components
- Pilot tone detection for cable supervision
- Dedicated Array EQ and Delay DSP
- Recallable DSP/configuration presets

	TG5	TG7	RCM-26	RCM-28
Topology	Class-H grounded bridge		Class-H grounded bridge	
Impedance	2 Ω 4 Ω 8 Ω	2 Ω 4 Ω 8 Ω		
Continuous Output/Channel (1 kHz, THD 1%)	2000 W 1450 W 850 W	3500 W 2500 W 1500 W		
Continuous Output/Channel (20-20,000 Hz, THD < 0.2%)		1200 W 600 W	2100 W 1050 W	
Maximum Bridged Output: 4, 8 Ω		3800 W 2900 W	7000 W 5000 W	
Amplifier Gain (Selectable)	39, 35 or 32 dB		41.5, 35 or 32 dB	
Signal-to-Noise Ratio (A-weighted)	109 dB	111 dB	116 dB	120 dB
Total Harmonic Distortion	0.05%	0.05%	<0.005% (THD+Noise)	<0.002% (THD+Noise)
Intermodulation Distortion (SMPTE)	0.05%	0.05%		
DIM 30	0.02%	0.02%		
Slew Rate	30 V/μs	35 V/μs		
Analog Inputs	Yes	Yes	2 audio inputs on internal slot connector, pre-/post-fader selectable	
Input Impedance (Balanced)	20 kΩ	20 kΩ		
Input Sensitivity (Selectable)	0, +6, +7 dBu	0, +6, +9 dBu		
Digital Inputs	Optional (RCM-26 / RCM-28)		Optional (RCM-26 / RCM-28)	
A/D Conversion	See RCM-26 / RCM-28		See RCM-26 / RCM-28	
D/A Conversion	See RCM-26 / RCM-28		See RCM-26 / RCM-28	
Data Format	See RCM-26 / RCM-28		See RCM-26 / RCM-28	
Internal Processing	See RCM-26 / RCM-28		See RCM-26 / RCM-28	
Sample Rate	See RCM-26 / RCM-28		See RCM-26 / RCM-28	
Sample Rate Conversion (SRC)	See RCM-26 / RCM-28		See RCM-26 / RCM-28	
Network Control (IRIS-Net)	Optional (RCM-26 / RCM-28)		Optional (RCM-26 / RCM-28)	
Control Protocol	See RCM-26 / RCM-28		See RCM-26 / RCM-28	
CAN Bus Interface	See RCM-26 / RCM-28		See RCM-26 / RCM-28	
GPIO Control Port	See RCM-26 / RCM-28		See RCM-26 / RCM-28	
FIR-Drive	Optional (RCM-26 / RCM-28)		Optional (RCM-26 / RCM-28)	
Power Supply	100-240 V, 50-60 Hz		100-240 V, 50-60 Hz	
Power Consumption 1/8 max. output @ 4 Ω	1000 W		1450 W	
Dimensions (H x W x D)	3.47" x 19" x 20.16" (88.1 x 482.6 x 512 mm)		3.33" x 3.17" x 9.06" (84.7 x 80.4 x 230.3 mm)	
Net Weight	31.4 lb (14.2 kg)		32 lb (14.5 kg)	



Building on a legacy of power and performance, Q Series amps take Electro-Voice's unique amplifier philosophy to a new level of efficiency and value. The Q series achieves superb audio performance because it's designed for superior dynamic headroom and transient response, resulting in 30% greater output capability for short-duration signals. High-power Q99 and Q1212 models use sophisticated Class-H topology that dramatically reduces heat and cuts energy consumption by up to 50%, yielding racks that are easier to power and

easier to cool. Smaller Q44 and Q66 models are based on the proven Class-AB designs of EV's reference-standard Precision series. All models incorporate dynamic limiting to prevent dangerous output clipping, as well as extensive protections against thermal damage and electrical malfunction. Combining Class-H innovation with Class-AB sonic excellence and robustness, the compact, affordable Q Series is the ideal amplifier line for all sizes of clubs, concerts, performance centers and sports venues.



Q44 650 W PER CHANNEL POWER AMPLIFIER



- Outstanding value and performance for club and mobile systems
- Dynamic headroom for all real-world applications
- 650 W per channel (2 Ω)
- Class-AB design
- XLR pass-through input connections
- Easy connection to biamped loudspeakers
- Switchable LPN filter for extra tonal fundamentals and "kick"
- Protective low-cut for systems without subwoofers
- Built-in dynamic limiters
- Complete protection package
- 3-stage front-to-rear fans

Q66 900 W PER CHANNEL POWER AMPLIFIER



- Outstanding value and performance for clubs, mobile and more
- Dynamic headroom for all real-world applications
- 900 W per channel (2 Ω)
- Class-AB design
- XLR pass-through input connections
- Easy connection to biamped loudspeakers
- Switchable LPN filter for extra tonal fundamentals and "kick"
- Protective low-cut for systems without subwoofers
- Built-in dynamic limiters
- Complete protection package
- 3-stage front-to-rear fans

Q99 1250 W PER CHANNEL CLASS-H POWER AMPLIFIER



- High-efficiency power and performance
- Innovative Class-H design
- 1250 W per channel (2 Ω)
- Dynamic headroom for all real-world applications
- XLR pass-through input connections
- Easy connection to biamped loudspeakers
- Switchable LPN filter for extra tonal fundamentals and "kick"
- Protective low-cut for systems without subwoofers
- Built-in dynamic limiters
- Complete protection package
- 3-stage front-to-rear fans

Q1212 1800 W PER CHANNEL CLASS-H POWER AMPLIFIER



- Super-efficient power with outstanding performance
- Innovative Class-H design
- 1800 W per channel (2 Ω)
- Dynamic headroom for all real-world applications
- XLR pass-through input connections
- Easy connection to biamped loudspeakers
- Switchable LPN filter for extra tonal fundamentals and "kick"
- Protective low-cut for systems without subwoofers
- Built-in dynamic limiters
- Complete protection package
- 3-stage front-to-rear fans

	Q44			Q66			Q99			Q1212		
Topology	Class-AB			Class-AB			Class-H			Class-H		
Impedance	2 Ω	4 Ω	8 Ω	2 Ω	4 Ω	8 Ω	2 Ω	4 Ω	8 Ω	2 Ω	4 Ω	8 Ω
Continuous Output Power(1 kHz, THD 1%)	650 W	450 W	270 W	900 W	600 W	380 W	1250 W	900 W	550 W	1800 W	1200 W	750 W
Continuous Output Power(20 - 20,000 Hz, THD < 0.2%)		400 W	200 W		500 W	250 W		800 W	400 W		1100 W	550 W
Maximum Bridged Output		1300 W	900 W		1800 W	1200 W		2800 W	1800 W		3600 W	2400 W
Amplifier Gain	32 dB			32 dB			32 dB			32 dB		
Frequency Response	10 Hz – 40 kHz (±1 dB)			10 Hz – 40 kHz (±1 dB)			10 Hz – 40 kHz (±1 dB)			10 Hz – 40 kHz (±1 dB)		
Signal-to-Noise Ratio (A-weighted)	106 dB			107 dB			109 dB			110 dB		
Total Harmonic Distortion	0.03%			0.03%			0.03%			0.03%		
Intermodulation Distortion (SMPTE)	0.1%			0.1%			0.1%			0.1%		
DIM 30	0.05%			0.05%			0.05%			0.05%		
Input Impedance (Balanced)	20 kΩ			20 kΩ			20 kΩ			20 kΩ		
Input Sensitivity	+2.2 dBu			+3.1 dBu			+5.1 dBu			+6.6 dBu		
Maximum Input Voltage	+21 dBu (8.69 Vrms)			+21 dBu (8.69 Vrms)			+21 dBu (8.69 Vrms)			+21 dBu (8.69 Vrms)		
Slew Rate	25 V/μs			26 V/μs			27 V/μs			30 V/μs		
Network Control (IRIS-Net)	No			No			No			No		
Protections	Audio limiters, high temperature, DC, HF, back EMF, peak current limiters, inrush current limiters, turn-on delay											
Cooling	Front-to-rear, 3-stage fans			Front-to-rear, 3-stage fans			Front-to-rear, 3-stage fans			Front-to-rear, 3-stage fans		
Dimensions (H x W x D)	3.47" x 19.02" x 16.63" (88.1 x 483 x 421.5 mm)			3.47" x 19.02" x 16.59" (88.1 x 483 x 421.5 mm)			3.47" x 19.02" x 16.59" (88.1 x 483 x 421.5 mm)			3.47" x 19.02" x 16.59" (88.1 x 483 x 421.5 mm)		
Net Weight	2778 lb (12.6 kg)			32.63 lb (14.8 kg)			35.94 lb (16.3 kg)			39.02 lb (17.7 kg)		

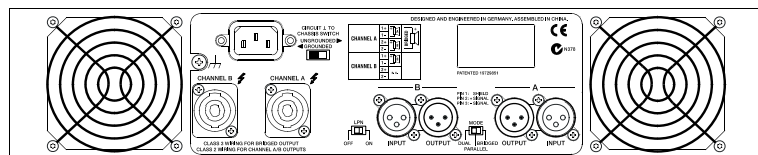

Q44, Q66, Q99 and Q1212 rear view

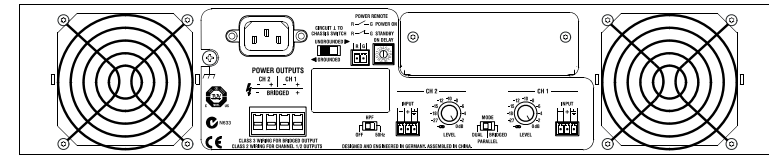

CPS 2.4, CPS 2.6, CPS 2.9 and CPS.12 rear view

Contractor Precision Series amplifiers combine top-quality performance and reliability with innovative designs perfectly tailored to the needs of professional sound installation. Available in 2RU configurations of up to eight channels, CPS amps are compact and efficient to operate, with every detail thought through from the contractor's point of view. For fast installation and setup, each model features Phoenix-type input and output connectors, programmable power-on delay, remote power-on/off, rear-mounted attenuators and switchable high-pass filters.

For worry-free dependability, there's full protection against hazards, such as excessive heat, overloads, shorts, HF, DC, back EMF and inrush current. And for the ultimate in system control and supervision, the optional RCM-810 module enables the inclusion of CPS amps in IRIS-Net networks of up to 250 devices. Offering exceptional ease, flexibility and audio performance, CPS series is the ideal installation solution for cinema, club sound, commercial sound/life safety, and performance and sports venues.

UNIQUE FLEXIBILITY THROUGH VLD
The ability to switch individually the mode of each power amp channel helps the DSA multi-channel power amplifiers to achieve a degree of flexibility never before possible. In low impedance operation (2 Ω, 4 Ω, 8 Ω), each channel can drive up to four 8 Ω loudspeaker cabinets. The output channels can also be paired in bridged mode. Depending upon the application, each channel can be switched individually even in high-impedance (Hi-Z) mode in order to drive 70 Vrms or 100 Vrms loudspeaker lines directly without an output transformer (Direct Drive). The power output by the DSA multi-channel power amplifiers is (along with its thermal capacity) limited only by their maximum output voltage and maximum output current, which means they can drive any load between 2 and 10 Ω with their rated maximum outputs of 500 W and 1000 W respectively per channel.

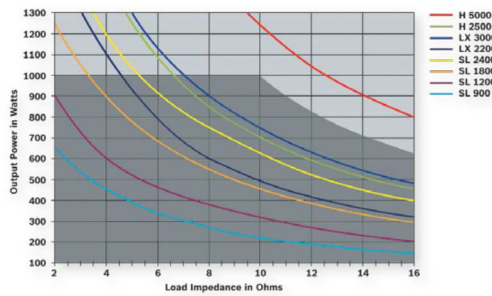

A corresponding encoder-circuit is provided on the rear panel. In addition, through VLD (Variable Load Drive) in combination with a RCM-810 remote control module, it is possible to define freely which output power should be made available at which load in the frame described above in the channel in question: e.g. Channel A = 350 W into 2.6 Ω; Channel B = 500 W into 8 Ω, etc.

CPS 2.4 650 W PER CHANNEL POWER AMPLIFIER



- Contractor-friendly performance and reliability
- 650 W per channel (2 Ω)
- Slot for optional RCM-810 module, allowing IRIS-Net control and monitoring
- Rear-mounted attenuators
- Switchable 50 Hz high-pass filter
- Class-AB design
- Complete protection: thermal, overload, shorts, HF, DC, back EMF and inrush current
- Phoenix-type input and output connections
- Remote power-on/off contact
- Programmable power-on delay settings
- 3-stage front-to-rear fans

CPS 2.6 900 W PER CHANNEL POWER AMPLIFIER



- Contractor-friendly performance and reliability
- 900 W per channel (2 Ω)
- Slot for optional RCM-810 module, allowing IRIS-Net control and monitoring
- Rear-mounted attenuators
- Switchable 50 Hz high-pass filter
- Class-AB design
- Complete protection: thermal, overload, shorts, HF, DC, back EMF and inrush current
- Phoenix-type input and output connections
- Remote power-on/off contact
- Programmable power-on delay settings
- 3-stage front-to-rear fans

CPS 2.9 1250 W PER CHANNEL CLASS-H POWER AMPLIFIER



- Power and efficiency for installations
- Innovative Class-H design
- 1250 W per channel (2 Ω)
- Slot for optional RCM-810 module, allowing IRIS-Net control and monitoring
- Rear-mounted attenuators
- Switchable 50 Hz high-pass filter
- Complete protection: thermal, overload, shorts, HF, DC, back EMF and inrush current
- Phoenix-type input and output connections
- Remote power-on/off contact
- Programmable power-on delay settings
- 3-stage front-to-rear fans

CPS 2.12 1800 W PER CHANNEL CLASS-H POWER AMPLIFIER



- Power and efficiency for installations
- Innovative Class-H design
- 1800 W per channel (2 Ω)
- Slot for optional RCM-810 module, allowing IRIS-Net control and monitoring
- Rear-mounted attenuators
- Switchable 50 Hz high-pass filter
- Complete protection: thermal, overload, shorts, HF, DC, back EMF and inrush current
- Phoenix-type input and output connections
- Remote power-on/off contact
- Programmable power-on delay settings
- 3-stage front-to-rear fans

CPS 4.5 500 W PER CHANNEL 4-CHANNEL AMPLIFIER



- Four channels in one compact rack-efficient unit
- 500 W per channel
- 70/100 V operation for distributed systems
- Class-D design for optimum efficiency
- Slot for optional RCM-810 module, allowing IRIS-Net control and monitoring
- IRIS-Net selection of each channel's impedance (2–10 Ω in 0.1 Ω steps)
- Rear-mounted attenuators
- Switchable 50 Hz high-pass filter (Hi-Z mode)
- Complete protection: thermal, overload, shorts, HF, DC, back EMF and inrush current
- Phoenix-type input and output connections
- Remote power-on/off contact
- Programmable power-on delay settings
- Front-to-rear fans

CPS 4.10 1000 W PER CHANNEL 4-CHANNEL AMPLIFIER



- Four channels in one compact rack-efficient unit
- 1000 W per channel
- 70/100 V operation for distributed systems
- Class-D design for optimum efficiency
- Slot for optional RCM-810 module, allowing IRIS-Net control and monitoring
- IRIS-Net selection of each channel's impedance (2–10 Ω in 0.1 Ω steps)
- Rear-mounted attenuators
- Switchable 50 Hz high-pass filter (Hi-Z mode)
- Complete protection: thermal, overload, shorts, HF, DC, back EMF and inrush current
- Phoenix-type input and output connections
- Remote power-on/off contact
- Programmable power-on delay settings
- Front-to-rear fans

CPS 8.5 500 W PER CHANNEL 8-CHANNEL AMPLIFIER



- Eight channels in one compact rack-efficient unit
- 500 W per channel
- 70/100 V operation for distributed systems
- Class-D design for optimum efficiency
- Slot for optional RCM-810 module, allowing IRIS-Net control and monitoring
- IRIS-Net selection of each channel's impedance (2–10 Ω in 0.1 Ω steps)
- Rear-mounted attenuators
- Switchable 50 Hz high-pass filter (Hi-Z mode)
- Complete protection: thermal, overload, shorts, HF, DC, back EMF and inrush current
- Phoenix-type input and output connections
- Remote power-on/off contact
- Programmable power-on delay settings
- Front-to-rear fans

RCM-810 IRIS-NET REMOTE CONTROL MODULE FOR CPS SERIES AMPLIFIERS



- Enable powerful control and supervision capabilities
- Integrate up to 100 devices in each remote control network, 250 with multiple networks
- Support for 2-, 4- and 8-channel CPS models
- Freely programmable control inputs and outputs
- Load-monitoring for each channel
- Variable Load Drive for independent channel impedance on 4- and 8-channel amps (2–10 Ω in 0.1 Ω steps)

	CPS 2.4			CPS 2.6			CPS 2.9			CPS 2.12		
Topology	Class-AB			Class-AB			Class-H			Class-H		
Impedance	2 Ω	4 Ω	8 Ω	2 Ω	4 Ω	8 Ω	2 Ω	4 Ω	8 Ω	2 Ω	4 Ω	8 Ω
Continuous Output Power(1 kHz, THD 1%)	650 W	450 W	270 W	900 W	600 W	380 W	1250 W	900 W	550 W	1800 W	1200 W	750 W
Continuous Output Power(20-20,000 Hz, THD<0.2%)		400 W	200 W		500 W	250 W		800 W	400 W		1100 W	550 W
Maximum Bridged Output		1300 W	900 W		1800 W	1200 W		2800 W	1800 W		3600 W	2400 W
Amplifier Gain	32 dB			32 dB			32 dB			32 dB		
Frequency Response	10 Hz – 40 kHz (±1 dB)			10 Hz – 40 kHz (±1 dB)			10 Hz – 40 kHz (±1 dB)			10 Hz – 40 kHz (±1 dB)		
Total Harmonic Distortion	0.03%			0.03%			0.03%			0.03%		
Intermodulation Distortion (SMPTE)	0.1%			0.05%			0.1%			0.1%		
DIM 30	0.05%			0.02%			0.05%			0.05%		
Slew Rate	25 V/μs			26 V/μs			27 V/μs			30 V/μs		
Analog Inputs	2, electronically balanced, Phoenix-type			2, electronically balanced, Phoenix-type			2, electronically balanced, Phoenix-type			2, electronically balanced, Phoenix-type		
Input Impedance (Balanced)	20 kΩ			20 kΩ			20 kΩ			20 kΩ		
Input Sensitivity	2.2 dBu (1.0 V)			+3.1 dBu (1.1 Vrms)			+5.1 dBu (1.39 Vrms)			+6.6 dBu (1.66 Vrms)		
Maximum Input Voltage	+21 dBu (8.69 Vrms)			+21 dBu (8.69 Vrms)			+21 dBu (8.69 Vrms)			+21 dBu (8.69 Vrms)		
Crossover Type	Optional Modules			Optional Modules			Modular			Modular		
Network Control (IRIS-Net)	Optional (RCM-810 card)			Optional (RCM-810 card)			Optional (RCM-810 card)			Optional (RCM-810 card)		
CAN Bus Interface	Optional (RCM-810 card)			Optional (RCM-810 card)			Optional (RCM-810 card)			Optional (RCM-810 card)		
Variable Load Drive (VLD)	No			No			No			No		
Cooling	Front-to-rear, 3-stage fans			Front-to-rear, 3-stage fans			Front-to-rear, 3-stage fans			Front-to-rear, 3-stage fans		
Dimensions (H x W x D)	3.47" x 19" x 16.59" (88.1 x 482.6 x 421.5 mm)			3.47" x 19" x 16.59" (88.1 x 482.6 x 421.5 mm)			3.47" x 19" x 16.59" (88.1 x 482.6 x 421.5 mm)			3.47" x 19" x 16.59" (88.1 x 482.6 x 421.5 mm)		
Net Weight	27.8 lb (12.6 kg)			32.63 lb (14.8 kg)			35.94 lb (16.3 kg)			39.0 lb (17.7 kg)		

	CPS 4.5					CPS 4.10					CPS 8.5				
Topology	Class-D					Class-D					Class-D				
Impedance/Voltage	2 Ω	4 Ω	8 Ω	8 Ω VLD	70V/100V	2 Ω	4 Ω	8 Ω	8 Ω VLD	70V/100V	2 Ω	4 Ω	8 Ω	8 Ω VLD	70V/100V
Continuous Power/Channel (1 kHz, THD 1%)	500 W	500 W	250 W	500 W	500 W	1000 W	1000 W	500 W	1000 W	1000 W	500 W	500 W	250 W	500 W	500 W
Continuous Power/Channel (20-20,000 Hz, THD < 0.3%)	450 W	450 W	225 W	450 W	450 W	900 W	900 W	450 W	900 W	900 W	450 W	450 W	225 W	450 W	450 W
Maximum Bridged Output				1000 W	1000 W				1000 W	1000 W				1000 W	1000 W
Amplifier Gain	32 dB (Lo-Z), 33 dB (70 V), 36 dB (100 V)					32 dB (Lo-Z), 33 dB (70 V), 36 dB (100 V)					32 dB (Lo-Z), 33 dB (70 V), 36 dB (100 V)				
Frequency Response	15 Hz – 30 kHz					15 Hz – 30 kHz					15 Hz – 30 kHz				
Signal-to-Noise Ratio, A-weighted (4 Ω)	100 dB					103 dB					100 dB				
Total Harmonic Distortion	0.05%					0.05%					0.05%				
Intermodulation Distortion (SMPTE)	0.05%					0.05%					0.05%				
DIM 30	0.02%					0.02%					0.02%				
Slew Rate	28 V/μs					28 V/μs					28 V/μs				
Analog Inputs	4, electronically balanced, Phoenix-type					4, electronically balanced, Phoenix-type					8, electronically balanced, Phoenix-type				
Input Impedance (Balanced)	20 kΩ					20 kΩ					20 kΩ				
Input Sensitivity	0 dBu (775 V)-2 Ω, +3 dBu (1.1 V)-4/8 Ω, +6 dBu (1.55) 70V/100V					0 dBu (775 V)-2 Ω, +3 dBu (1.1 V)-4/8 Ω, +6 dBu (1.55) 70V/100V					0 dBu (775 V)-2 Ω, +3 dBu (1.1 V)-4/8 Ω, +6 dBu (1.55) 70V/100V				
Maximum Input Voltage	+22 (9.76 Vrms)					+22 (9.76 Vrms)					+22 (9.76 Vrms)				
Network Control (IRIS-Net)	Optional (RCM-810 card)					Optional (RCM-810 card)					Optional (RCM-810 card)				
CAN Bus Interface	Optional (RCM-810 card)					Optional (RCM-810 card)					Optional (RCM-810 card)				
Variable Load Drive (VLD)	Yes					Yes					Yes				
Cooling	Front-to-rear, continuously variable fans					Front-to-rear, continuously variable fans					Front-to-rear, continuously variable fans				
Dimensions (H x W x D)	3.47" x 19" x 16.59" (88.1 x 482.6 x 421.5 mm)					3.47" x 19" x 16.59" (88.1 x 482.6 x 421.5 mm)					3.47" x 19" x 16.59" (88.1 x 482.6 x 421.5 mm)				
Net Weight	24.47 lb (11.1 kg)					24.47 lb (11.1 kg)					30.64 lb (13.9 kg)				

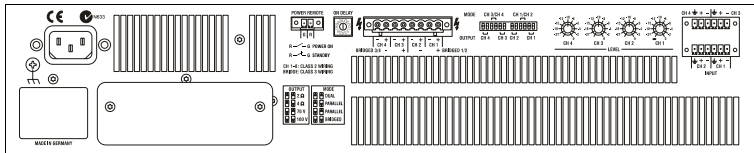

CPS 4.5 and CPS 4.10 rear view

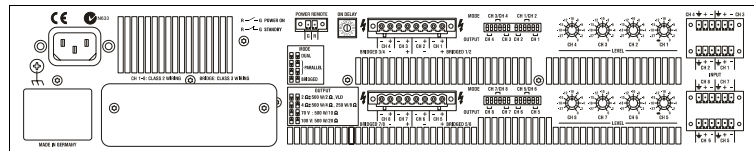

CPS 8.5 rear view



Compact Precision amplifiers combine outstanding audio performance with the highest-possible reliability and safety to create an ideal high-power solution for touring and rentals. Incorporating an innovative switchmode power supply into Class-H technology, the CP series delivers clean headroom that is far above stated nominal output. This advanced design also results in improved performance-to-weight ratio for easier touring, reduced waste heat for closer rack spacing and reduced power

consumption for enhanced energy efficiency. A complete set of protection circuitry guards people and equipment against hazardous conditions, and a rigid, robust chassis, built to the highest precision manufacturing standards, ensures dependable operation on even the most grueling tours. With exceptionally clean power and tour-friendly touches that facilitate fast, flexible setup, Compact Precision amplifiers fulfill even the most demanding requirements of pro audio touring.

CP3000S

1600 W PER CHANNEL CLASS-H POWER AMPLIFIER



- Advanced high-efficiency Class-H design
- Ideal for demanding concerts and tours
- Exceptional dynamic headroom
- Rugged, compact and lightweight
- 1600 W per channel (2 Ω)
- XLR pass-through input connections
- Easy connection to biamped loudspeakers
- Switch mode power supply
- Built-in dynamic limiters
- Complete protection: thermal, overload, shorts, HF, DC, back EMF and inrush current
- 3-stage front-to-rear fans

CP4000S

2100 W PER CHANNEL CLASS-H POWER AMPLIFIER



- High power with advanced Class-H efficiency
- Ideal for demanding concerts and tours
- Exceptional dynamic headroom
- Rugged, compact and lightweight
- 2100 W per channel (2 Ω)
- XLR pass-through input connections
- Easy connection to biamped loudspeakers
- Switch mode power supply
- Built-in dynamic limiters
- Complete protection: thermal, overload, shorts, HF, DC, back EMF and inrush current
- 3-stage front-to-rear fans

	CP3000S			CP4000S		
Topology	Class-H			Class-H		
Impedance	2 Ω	4 Ω	8 Ω	2 Ω	4 Ω	8 Ω
Maximum power (1k Hz, THD < 1%)	1600 W	1100 W	600 W	2100 W	1500 W	900 W
Rated power (20 Hz-20,000 Hz; THD < 0.2%)		900 W	450 W		1200 W	600 W
Maximum bridged output (1,000 Hz; < 1% THD)		3200 W	2200 W		4200 W	3000 W
Frequency Response (-1dB, ref. 1kHz)	15 Hz – 40 kHz			15 Hz – 40 kHz		
Signal-to-noise ratio, A-weighted	107 dB			108 dB		
Total harmonic distortion	<0.05%			<0.05%		
Intermodulation distortion (SMPTE)	<0.02%			<0.02%		
Slew rate	35 V/μs			35 V/μs		
Input impedance (balanced)	20 kΩ			20 kΩ		
Crosstalk (at 1,000 Hz)	<-80 dB			<-80 dB		
Dimensions (W x H x D)	19.02" x 3.47" x 15.12" (483 x 88.1 x 384 mm)			19.02" x 3.47" x 15.12" (483 x 88.1 x 384 mm)		
Net weight	17.97 lb (8.15 kg)			19.18 lb (8.70 kg)		

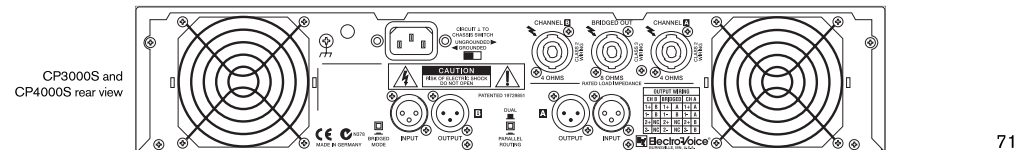

CP3000S and CP4000S rear view



PA Series

The PA Series of commercial power amplifiers is a favorite of installers everywhere for sound reinforcement, background music, paging and public address systems. Featuring low-distortion amplifier electronics that are bridgeable for flexible power allocation, PA Series amps provide a wide dynamic range with excellent headroom. An onboard limiter spares both amplifier and speakers from damaging transients, and a comprehensive thermal/electrical protection package ensures long-haul dependability. Equipped with Phoenix-style terminals for

fast, easy hookup, PA Series amps are housed in compact, rack-ready 2RU chassis with ample internal airflow and exceptionally quiet multi-stage fans. Models are available in a variety of output powers and channel configurations, several of which provide 70 V/100 V output using low-distortion transformers. Offering outstanding versatility and long-term reliability, the PA Series is a remarkable value for any installation application.

PA1250T SINGLE-CHANNEL 250 W POWER AMPLIFIER



- Cool-running, saturation-free power for distributed installations
- Ideal for sound reinforcement, paging and life safety
- 250 W mono for 70 V/100 V lines
- Compact 2RU design
- Stepped rear-panel level attenuation
- Selectable 50 Hz or 300 Hz high-pass filter
- Thermal protection, peak limiting, turn-on delay
- Phoenix-type inputs and outputs
- 3-stage front-to-rear fans
- Integrated rack ears for direct mounting

PA2250T DUAL 270 W PER CHANNEL POWER AMPLIFIER



- Efficient performance for low impedance or distributed systems
- Ideal for sound reinforcement, paging and life safety
- 250 W per channel for 4 Ω or 70 V/100 V lines
- Bridged mono out for 540 W into 8 Ω
- Compact 2RU design
- Stepped rear-panel level attenuation
- Selectable 50 Hz or 300 Hz high-pass filter
- Thermal protection, peak limiting, turn-on delay
- Phoenix-type inputs and outputs
- 3-stage front-to-rear fans
- Integrated rack ears for direct mounting

PA2400T DUAL 400 W PER CHANNEL POWER AMPLIFIER



- Efficient performance for low impedance or distributed systems
- Ideal for sound reinforcement, paging and life safety
- 400 W per channel for 4 Ω or 70 V/100 V lines
- Bridged mono out for 860 W into 8 Ω
- Compact 2RU design
- Stepped rear-panel level attenuation
- Selectable 50 Hz or 300 Hz high-pass filter
- Thermal protection, peak limiting, turn-on delay
- Phoenix-type inputs and outputs
- 3-stage front-to-rear fans
- Integrated rack ears for direct mounting

PA2450L DUAL 450 W PER CHANNEL POWER AMPLIFIER



- Reliable high-quality power for installation
- Ideal for sound reinforcement, paging and life safety
- 450 W per channel for 4 Ω or 70 V/100 V lines
- Bridged mono out for 900 W into 8 Ω
- Compact 2RU design
- Stepped rear-panel level attenuation
- Selectable 50 Hz or 300 Hz high-pass filter
- Thermal protection, peak limiting, turn-on delay
- Phoenix-type inputs and outputs
- 3-stage front-to-rear fans
- Integrated rack ears for direct mounting

PA4150L



QUAD 150 W PER CHANNEL POWER AMPLIFIER

- Flexible multi-channel power for installation
- Ideal for sound reinforcement, paging and life safety
- 150 W per channel into 4 Ω
- Bridged mode for dual 315 W outputs into 8 Ω
- Compact 2RU design
- Stepped rear-panel level attenuation
- Selectable 50 Hz or 300 Hz high-pass filter
- Thermal protection, peak limiting, turn-on delay
- Phoenix-type inputs and outputs
- 3-stage front-to-rear fans
- Integrated rack ears for direct mounting

	PA1250T	PA2250T	PA2400T	PA2450L	PA4150L
Number of Channels	1	2	2	2	4
Signal-to-Noise Ratio, A-weighted	103 dB	103 dB	103 dB	104 dB	101 dB
Impedance/Voltage	70 V/100 V	4 Ω 8 Ω	70 V/100 V 4 Ω 8 Ω	70 V/100 V 4 Ω 8 Ω	4 Ω 8 Ω
Rated output power (rated load) THD <1%, 1 kHz	270 W	270 W 135 W	270 W 430 W 215 W	430 W 450 W 220 W	160 W 100 W
Rated output power (rated load) THD <0.2%, 20 Hz – 20 kHz	250 W	250 W 125 W	250 W 400 W 200 W	400 W 200 W	150 W 75 W
Slew rate (V/μs) at 1 kHz	41/61	18 18	41/61	25 25 46/65	28 28 16 16
Frequency response -1 dB, ref. 1 kHz	65 Hz – 20 kHz	65 Hz – 40 kHz	65 Hz – 40 kHz	<10 Hz – 40 kHz	<10 Hz – 40 kHz
THD @ rated output power MBW=80 kHz, 1 kHz	<0.1%	<0.1%	<0.1%	<0.1%	<0.1%
IMD-SMPTE 60 Hz, 7 kHz	<0.1%	<0.1%	<0.1%	<0.1%	<0.1%
DIM30 3.15 kHz, 1.5 kHz	<0.1%	<0.1%	<0.1%	<0.1%	<0.1%
Input impedance, 20–20,000 Hz	>20 kΩ balanced	>20 kΩ	>20 kΩ	>20 kΩ	>20 kΩ
Input sensitivity @ rated output power or voltage, 1 kHz	0 dBu (775 mV)	0 dBu (775 mV)	0 dBu (775 mV)	0 dBu (775 mV)	0 dBu (775 mV)
Crosstalk 1 kHz, @ 10% rated output power	<-75 dB	<-75 dB	<-75 dB	<-75 dB	<-75 dB
Dimensions (W x H x D)	19" x 3.5" x 16" (483 x 88 x 406 mm)	19" x 3.5" x 16" (483 x 88 x 406 mm)	19" x 3.5" x 16" (483 x 88 x 406 mm)	19" x 3.5" x 16" (483 x 88 x 406 mm)	19" x 3.5" x 16" (483 x 88 x 406 mm)
Net Weight	36.34 lb (16.5 kg)	51.76 lb (23.5 kg)	57.27 lb (26 kg)	36.34 lb (16.5 kg)	39.65 lb (18 kg)

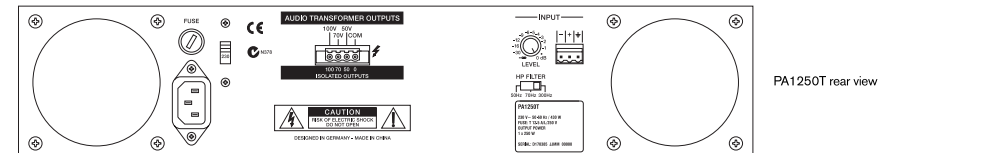

PA1250T rear view

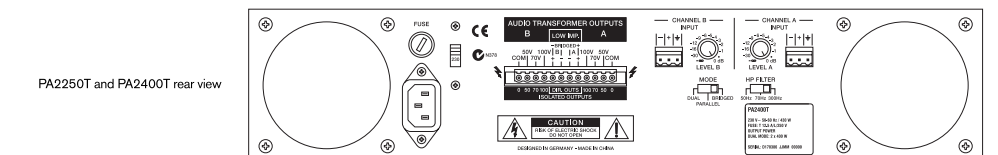

PA2250T and PA2400T rear view

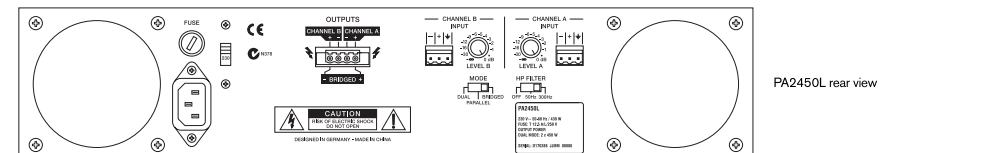

PA2450L rear view

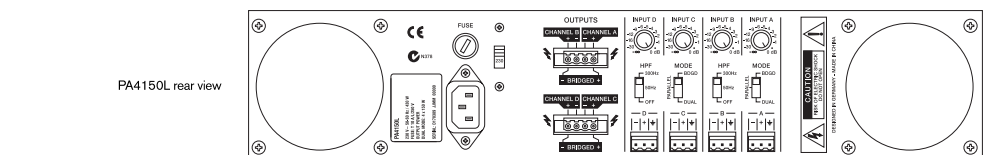

PA4150L rear view



The NetMax N8000 System Controller is a state-of-the-art digital matrix system offering comprehensive management of all aspects of professional sound reinforcement systems. Supporting both distributed and central processing, NetMax is a powerful physical complement to EV's IRIS-Net protocol, which gives designers and end-users the industry's most flexible routing, DSP, and component-level system control and supervision. EQ, crossovers, dynamics, FIR-Drive loudspeaker optimization—NetMax does it all with superior digital fidelity.

Each 2RU NetMax chassis supports up to 1900 MIPS of processing power and up to 32 local audio channels. And with NetMax's modular, field-configurable architecture, every system can be tailored to current needs without being locked out of future expansion. Designed for both installations and touring systems, NetMax is an indispensable tool for concert halls, houses of worship, hotels, casinos, convention centers, sporting arenas and stadiums. Simply put, there's no more powerful, intelligent way to tame the complexity of modern sound systems than NetMax.

N8000 NETMAX 300 MIPS DIGITAL MATRIX CONTROLLER



- Full IRIS-Net supervision, control and scheduling
- Comprehensive 32-channel routing and mixing
- Huge range of DSP filters, EQ, dynamics and delays
- FIR-Drive loudspeaker optimization
- 300 MIPS internal processing
- Up to 1000 MIPS of processing power available per unit
- 115 dB dynamic range for clean, quiet sound
- Internal 48-bit processing for outstanding audio fidelity
- Auto-compiling DSP engine with ultra-low fixed latency
- Modular architecture with hardware expansion slots
- Fully-programmable analog and digital GPIO support
- Support for Ethernet, RS-232, USB and CAN
- CobraNet and Dante audio networking options

DSP-1 N8000 300 MIPS DSP EXPANSION MODULE



- Enhanced DSP power for NetMax controllers
- Adds 300 MIPS computing capacity
- Easy field installation into chassis card slot
- 48-bit signal processing
- Two RAM banks (512 k x 24 bit) for delay lines up to 21.8 seconds
- Double-precision DSP algorithms
- Automatic configuration via IRIS-Net with installation/removal notification

DSP-2 N8000 1500 MIPS DSP EXPANSION MODULE



- Enhanced DSP power for NetMax controllers
- Adds 1500 MIPS computing capacity
- Easy field installation into chassis card slot
- Three additional RAM banks (512 k x 24 bit) for delay lines up to 32.7 seconds
- Double-precision DSP algorithms
- Automatic configuration via IRIS-Net with installation/removal notification

AI-1 NETMAX 8-CHANNEL ANALOG INPUT CARD



- Eight electronically balanced line-level inputs
- Euroblock connectors
- 20 kΩ input impedance
- 117 dB dynamic range for superior sonic quality
- Automatic configuration
- IRIS-Net notification of installation and removal
- On-board DSP (100 MIPS)

MI-1 NETMAX 8-CHANNEL ANALOG MIC/LINE INPUT CARD



- Eight electronically balanced mic/line inputs
- Euroblock connectors
- 48 V phantom power
- Mic/line pad, selectable via IRIS-Net
- Gain and level adjustable via IRIS-Net
- Automatic configuration
- IRIS-Net notification of installation and removal
- On-board DSP (100 MIPS)

DI-1 NETMAX 8-CHANNEL DIGITAL INPUT CARD



- Eight channels of AES/EBU or S/PDIF digital audio
- Four input connectors, Euroblock or TOSLINK optical
- Supports sample rates from 32–192 kHz
- Independent sample rate conversion for each input
- Lock indication LED
- On-board DSP (100 MIPS)

AO-1 NETMAX 8-CHANNEL ANALOG OUTPUT CARD



- Eight electronically balanced line-level outputs
- Euroblock connectors
- 118 dB dynamic range for superior sonic quality
- 100 Ω output impedance
- Automatic configuration
- IRIS-Net notification of installation and removal
- On-board DSP (100 MIPS)

DO-1 NETMAX 8-CHANNEL DIGITAL OUTPUT CARD



- Eight channels of AES/EBU digital audio output
- Four Euroblock output connectors
- 48 kHz sample rate
- +21 dBu maximum output level
- Automatic configuration via IRIS-Net with installation/removal notification
- On-board DSP (100 MIPS)

CM-1 NETMAX COBRANET AUDIO NETWORK MODULE



- Connect NetMax to a CobraNet digital audio network
- Two 100BASE-TX Ethernet interfaces (IEEE 802.3u compatible) for system redundancy
- 100 mbps data transmission rate
- Four serial ports each for input and output for a total of up to 32 ins and 32 outs
- 48 kHz sample rate and 16-, 20- or 24-bit word-length
- Control, monitoring, configuration and firmware updates via Ethernet
- Status LEDs for link, activity, fault and CobraNet conductor status

DM-1 NETMAX DANTE AUDIO NETWORK MODULE



- Connect NetMax to a Dante digital audio network
- Transmit up to 32 ins and 32 outs at 48 kHz sample rate and 16-, 20- or 24-bit word-length
- Low latency (typically below 1 ms)
- Two Gigabit Ethernet interfaces for system redundancy
- Status LEDs for each interface
- Dante Zen device-discovery
- Compatible with Dante Virtual Soundcard

TPI-5 5.7" TOUCH PANEL CONTROLLER FOR IRIS-NET SYSTEMS



- Custom control surface design
- Custom graphical user interfaces via IRIS-Net
- Functionality and graphical representation for a wide range of applications
- No fan, no hard disk
- Reliable server technology
- Operates independently or in conjunction with additional IRIS-Net applications to provide maximum flexibility
- High durability
- Built to industrial standards, ensuring robust and reliable operation in even the most demanding of environments

PWS-4, PWS-6, PWS-C PROGRAMMABLE WALL STATIONS



- Modular standard-mount keypads for NetMax
- Convenient control for volume, source, presets, etc.
- Up to three front units in a wall station
- PWS-C connects front units to CAN bus
- Easy daisy-chaining with included connection wire
- Easy labeling, protected by transparent cover
- Integrated status LEDs
- Button and LED configuration via IRIS-Net
- Customizable button behavior (momentary, latching or radio)



Sound System Processors

Proven in thousands of installations and live applications around the world, EV delivers truly state-of-the-art DSP for today's applications. EV's Dx46 sets the standard for digital loudspeaker controllers, providing 48-bit filter algorithms, 24-bit AD/DA conversion and a dynamic range of 115 dB.

Dx46 TWO-IN/SIX-OUT FIR-DRIVE SOUND SYSTEM PROCESSOR



- IRIS-Net software provides complete control, monitoring and supervision
- FIR-Drive loudspeaker optimization
- Analog and AES/EBU inputs
- Switchable -6 dB pre-A/D converter pad
- 24-bit AD/DA conversion
- 48-bit filter algorithms
- 115 dB dynamic range
- Ethernet and USB data interfaces
- Dedicated array EQ and delay sections
- 4 separate delay sections
- 5 contact closure inputs
- 60 factory presets, 30 user presets
- Unique edit/compare mode for audible parameter adjustment
- Full loudspeaker protection package, including both Peak Anticipation and TEMP limiters
- Editor Software IRIS-Net

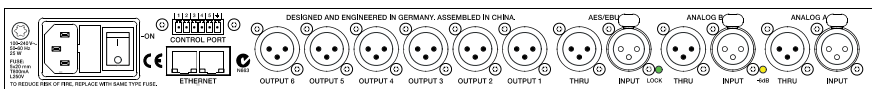

DC-One TWO-IN/SIX-OUT SOUND SYSTEM PROCESSOR



- DC-One Editor Software control via USB port
- Analog or AES/EBU Inputs
- Switchable -6 dB pre-A/D converter pad
- 24-bit AD/DA conversion
- 32-bit Floating Point internal processing
- 111 dB dynamic range
- Six predefined operation configurations
- Contact closure interface for remote preset recall
- 60 factory presets, 20 user presets
- Unique edit/compare mode for audible parameter adjustment
- Highly-customizable security settings

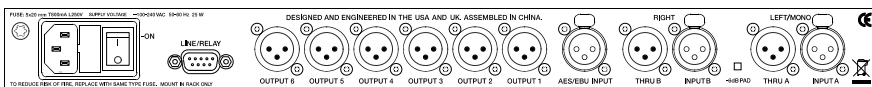

DC-One Editor Software PC-BASED EDITING SOFTWARE FOR DC-ONE

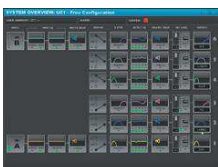

- Easy connection to DC-One hardware via USB
- Detailed, real-time control and supervision of DC-One hardware
- Intuitive user interface
- State-of-the-art graphics provide detailed, easy-to-understand system overview
- Graphical navigation and block diagrams provide easy access to all functions and DSP sections
- Unique delay adjustment interface positions components as they actually exist in space
- Selective lockout of front-panel access protects settings from tampering
- Available as a free download at www.electrovoice.com



	Dx46	DC-One
Analog Inputs (Electronically Balanced)	Two XLR, Two XLR THRU OUT	Two XLR, Two XLR THRU OUT
Analog Outputs (Electronically Balanced)	Six XLR	Six XLR
Digital Inputs	XLR AES/EBU (2-channel)	XLR AES/EBU (2-channel)
Maximum Input Voltage	8.7 V/+21 dBu (analog pad not engaged)	8.7 V/+21 dBu (analog pad not engaged)
Nominal Input Voltage	1.55 V/+ 6 dBu	1.23 V/+4 dBu
Input Impedance (Balanced)	10 kΩ	10 kΩ
Maximum Output Voltage	8.7 V/+21 dBu	8.7 V/+21 dBu
Nominal Output Voltage	1.55 V/+6 dBu	1.23 V/+4 dBu
Output Impedance (Balanced)	50 Ω	50 Ω
Frequency Response	20 Hz – 22 kHz (+/-0.5 dB)	10 Hz – 22 kHz (±0.5 dB)
Dynamic Range	116 dB (A-weighted)	111 dB (unweighted, band limited 22–22,000 Hz)
THD+N	<0.002% (band limited 20–20,000 Hz)	<0.01% (band limited 22–22,000 Hz)
A/D Conversion	24-bit Delta Sigma	24-bit/Sigma-Delta (linear phase) 128 times oversampling
D/A Conversion	24-bit Delta Sigma	24-bit/Sigma-Delta 128 times oversampling
Data Format	24-bit	24-bit
Internal Processing	48-bit double precision	32-bit floating point
Sample Rate	48 kHz	48 kHz
Control Protocol	USB, Ethernet	Front-panel USB port
Dimensions (H x W x D)	1.74" x 19" x 14" (44.25 x 482.6 x 355.6 mm)	1.74" x 19" x 14" (44.25 x 482.6 x 355.6 mm)
Net Weight	10.14 lb (4.6 kg)	10.14 lb (4.6 kg)

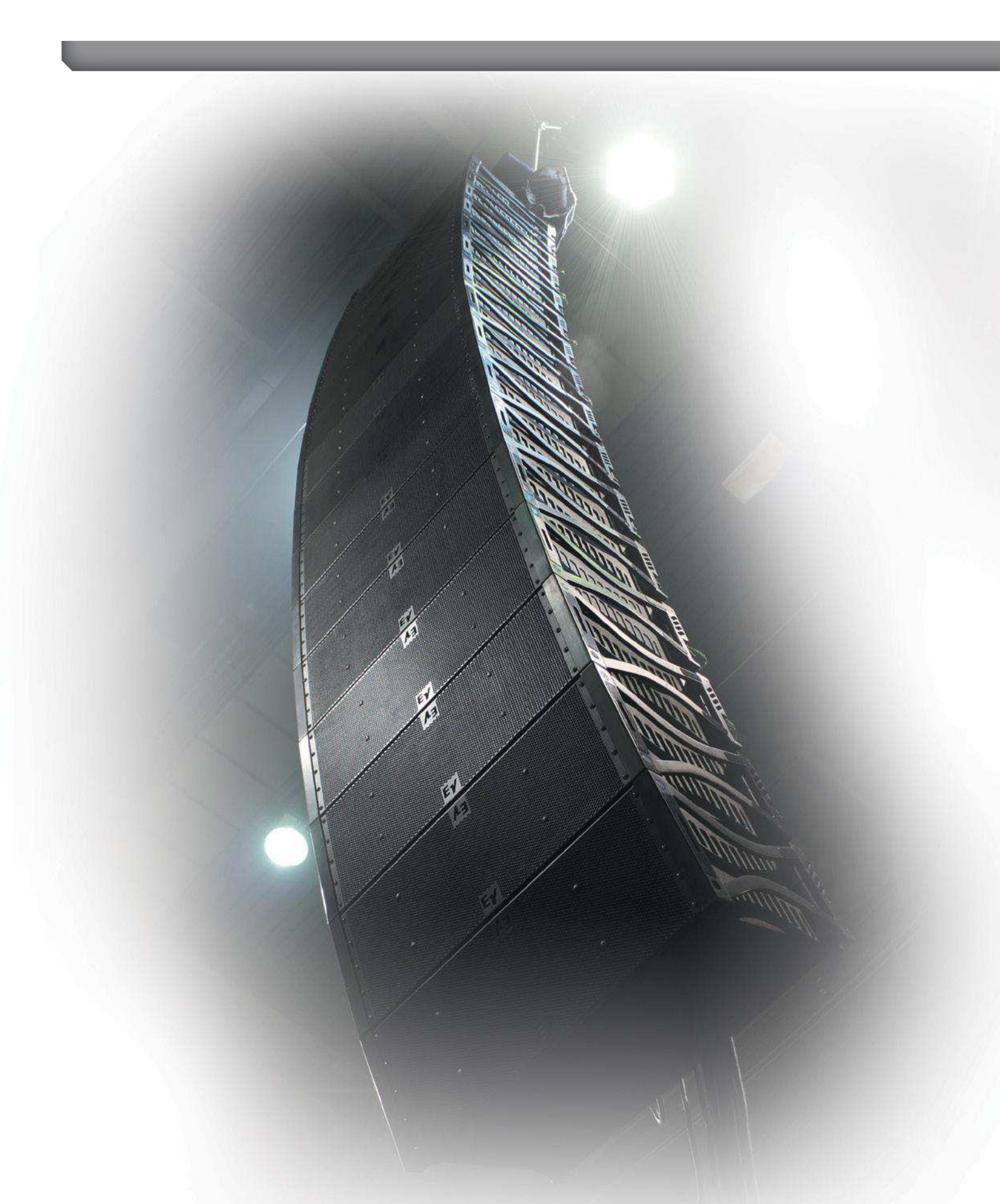

Electro-Voice