

Evo All In One Player

Manual Generated: 08/06/2022 - 09:13

Table of Contents

Evo All In One Player	3
Introduction	4
Front panel controls	5
Evo display	6
Evo 150 rear panel connections	8
Evo 75 rear panel connections	10
Remote control	12
Replaceable side panel	13
Getting connected	14
ARC input	18
StreamMagic app - Setup	19
Google Home / Chromecast built-in	20
Bluetooth source	21
AirPlay	22
Spotify Connect	23
Bluetooth output	24
MQA (Master Quality Authenticated)	26
Settings	27
Info screen	29
Technical specifications	30
Troubleshooting	32

Evo All In One Player

Last updated: April 20, 2022 02:25. Revision #3751



User's Manual

Introduction

Last updated: April 28, 2022 05:36. Revision #3906

This guide is designed to make installing and using this product as easy as possible. Information in this document has been carefully checked for accuracy at the time of publishing; however, Cambridge Audio's policy is one of continuous improvement, therefore design and specifications are subject to change without prior notice.

This document contains proprietary information protected by copyright. All rights are reserved. No part of this manual may be reproduced by any mechanical, electronic or other means, in any form, without prior written permission of the manufacturer. All trademarks and registered trademarks are the property of their respective owners.

The Bluetooth® word mark and logos are registered trademarks owned by the Bluetooth SIG, Inc. and any use of such marks by Audio Partnership Plc is under license. Other trademarks and trade names are those of their respective owners.

Qualcomm is a trademark of Qualcomm Incorporated, registered in the United States and other countries, used with permission.

aptX is a trademark of Qualcomm Technologies International, Ltd., registered in the United States and other countries, used with permission. Qualcomm aptX is a product of Qualcomm Technologies International, Ltd.

StreamMagic is a trademark of Audio Partnership Plc and is registered in the European Community and other countries.

This product contains software licensed under version 2 of the GNU Public License and version 2.1 of the GNU Lesser Public License. The source code for this software is available from: <http://gpl.stream-magic.com/>

This product includes technology owned by Microsoft Corporation and under a licence from Microsoft Licensing GP. Use or distribution of such technology outside of this product is prohibited without a license from Microsoft Corporation and/or Microsoft Licensing, GP as applicable.

The Spotify software is subject to third party licenses found here: www.spotify.com/connect/third-party-licenses.

This product support AirPlay 2 and requires iOS 11.4 or later.

Apple and AirPlay are trademarks of Apple Inc., registered in the U.S. and other countries.

Use of the Works with Apple badge means that an accessory has been designed to work specifically with the technology identified in the badge and has been certified by the developer to meet Apple performance standards.

Android, Google Play and the Chromecast built-in logo are trademarks of Google Inc.

TIDAL and TIDAL logo are registered trademark of Aspiro AB in the European Union and other countries.

MQA and the Sound Wave Device are registered trade marks of MQA Limited © 2016.

© Copyright Cambridge Audio Ltd

For upcoming news on future products, software updates and exclusive offers, make sure you register your product at <https://www.cambridgeaudio.com/register>

Front panel controls

Last updated: February 7, 2022 03:41. Revision #3056

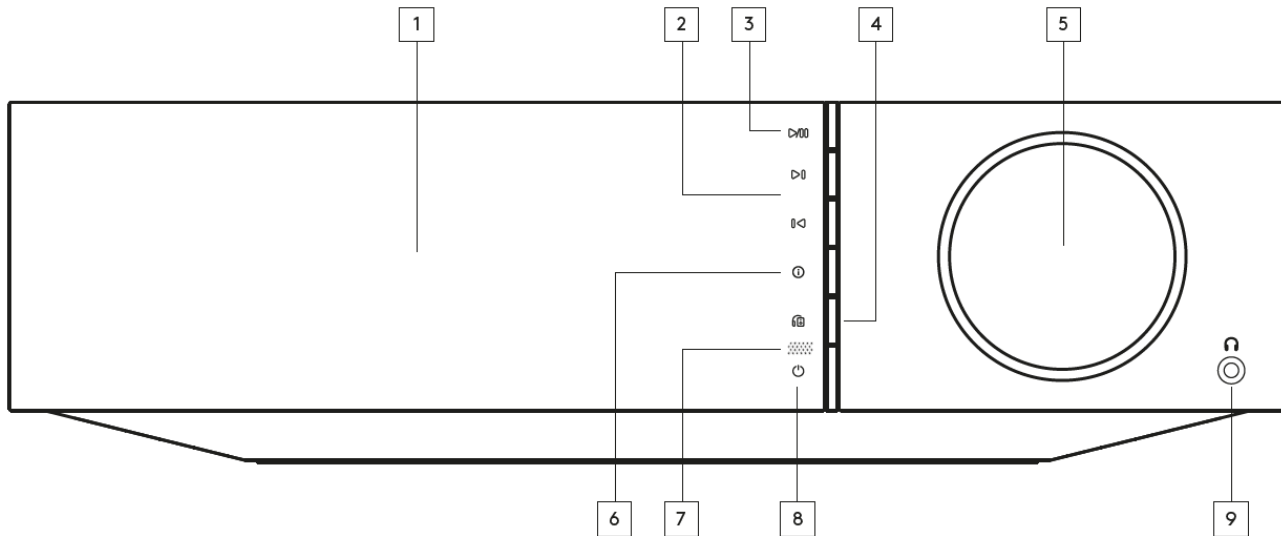

1. Display

2. Skip

3. Play/Pause

4. Speaker output

Press this button to choose a different speaker output from the menu. Use the source selector knob to select the speaker output between speaker A, speaker B, speaker A+B, headphone and Bluetooth devices.

Note: Speaker A, speaker B and speaker A+B are available on the [Evo 150 only](#).

5. Volume/Source selector

To change the volume, rotate the front part.
To select a source, rotate the back part.

6. Info

During playback, pressing this button will cycle through 'Now Playing' screens. Press and hold to display the product info.

7. IR sensor

8. Standby/On

9. Headphones

For suitable headphones - connection will automatically mute the speaker output and the pre-out.

Evo display

Last updated: January 24, 2022 02:56. Revision #3070

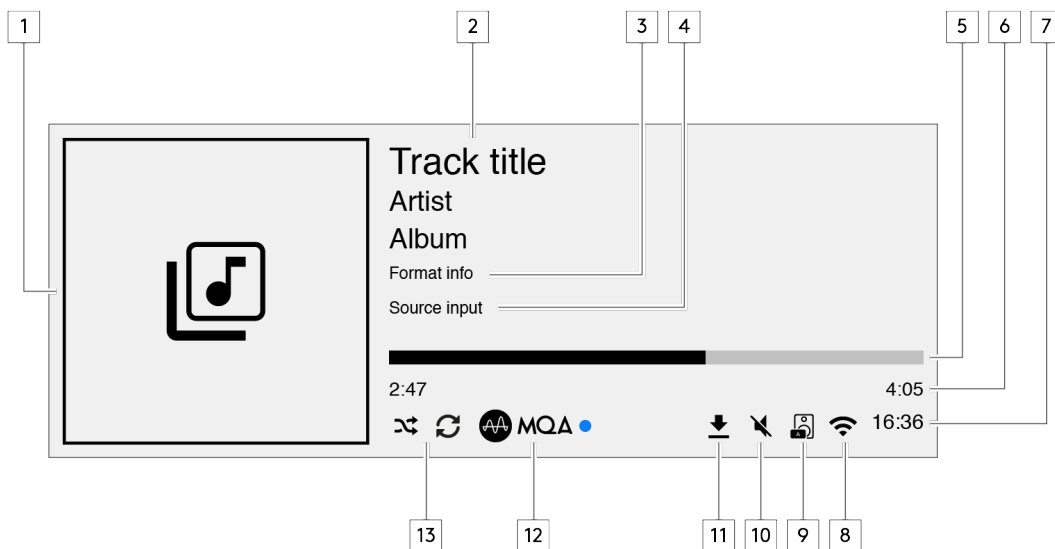

1. Album/Source artwork

Displays the album artwork. Alternatively, if no albums are available this will display the source input icon.

2. Track title, artist and album

For Internet Radio, this will display the radio station name and the current playback.

3. Format info

Displays the streaming sample rate. For Internet Radio, this will display the bitrate the station is streaming.

4. Source input

Displays the currently selected source input.

5. Progress bar

When available, this will display the current track progression during playback.

6. Track time

When available, this will display the elapsed track time during playback.

7. Clock

8. Network connection

Displays the current network connection.



Wireless network connection



Wireless connection with no internet access



Wired network connection



Wired connection with no internet access



No network connection

9. Speaker output

Displays the currently selected speaker output.

10. Mute volume

Displays when the network streamer is muted.

11. Firmware update

This indicates when new firmware is available. Press the 'Info' button on the front panel or use the StreamMagic app to update the network streamer's firmware.

12. MQA indicator

See the [MQA](#) section for more details.

13. Shuffle, Repeat and Repeat +1

Evo 150 rear panel connections

Last updated: February 7, 2022 03:42. Revision #3058

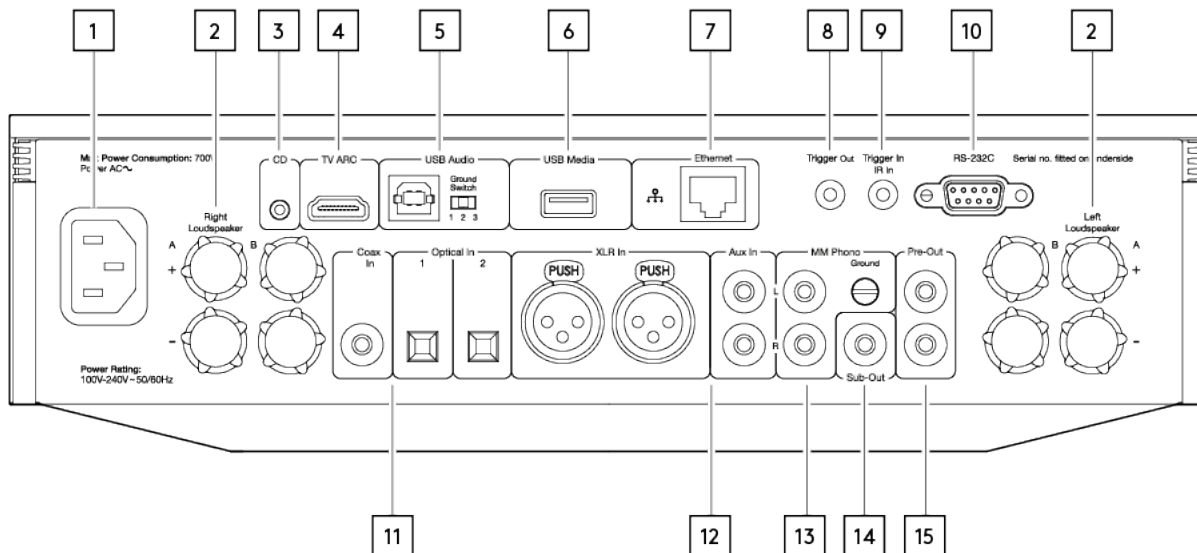

1. AC Power socket

2. Speaker terminals

B Speaker

For connecting a second pair of loudspeakers.

3. Evo CD

A dedicated connection from an Evo CD player.

4. Audio return channel (ARC)

A connection from a TV that supports ARC function.

5. USB Audio In

For connecting to PC/Mac computers.

Note: For Class 2 USB audio, Windows-based PCs require a Cambridge Audio USB driver to be installed before connection.

Ground Switch

Note: The ground switch position should be set to 1 as default. Use another position if a humming noise occurs.

Position 1 - Normal/default position. The main unit audio ground is lifted from chassis earth.

Position 2 - USB Audio ground is lifted from the main unit audio ground, which is also lifted from chassis earth. This may be useful to reduce hum and noise that can occur with some USB Audio setups.

Position 3 - Main unit audio ground is connected directly to chassis ground and USB Audio ground. For some setups, this can reduce hum or noise when certain TVs, Turntables, and other equipment are connected to the Evo unit.

6. USB Media

For connecting local media storage. Note that the USB ports are not intended for connection to Apple mobile devices; no functionality, charging or otherwise is supported.

7. Ethernet

Use a wired connection for seamless playback of high-resolution 352.8kHz, 384kHz, and DSD 256.

8. Trigger Out

Use a link wire between the Evo 150 and a product that has a trigger input. This will synchronise the power state of both products when powering the Evo 150 on/standby.

9. Trigger In/IR In

Trigger In - Use a link wire between a product that has a trigger output and the Evo 150. This will synchronise the power state of the Evo 150 with the controlling unit

IR In - Receives modulated IR commands from an IR repeater or custom install systems.

10. RS232C

Custom install control - a full protocol is available for the Evo 150 on our website.

11. Digital Inputs (Coax and Optical)

Note: If a digital input is connected to a TV you can enable TV mode in the input settings of the StreamMagic app. This mode minimises lip-sync delays on the audio path by bypassing MQA decoding and also reduces the chance of dropouts and glitches from some TVs.

12. Analogue Inputs (AUX/XLR)**13. MM Phono input**

For connecting a turntable that uses a moving magnet cartridge.

Ground

If your turntable has a separate grounding lead, then connect here.

14. Sub-Out**15. Pre-Out**

Evo 75 rear panel connections

Last updated: January 24, 2022 02:57. Revision #3071

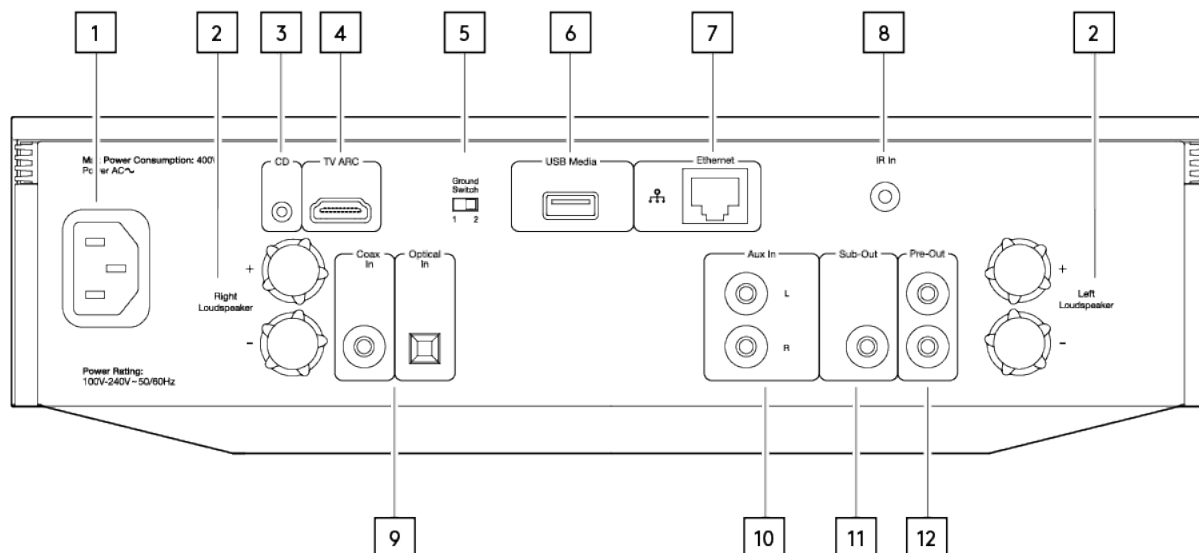

1. AC Power socket

2. Speaker terminals

3. Evo CD

A dedicated connection from an Evo CD player.

4. Audio return channel (ARC)

A connection from a TV that supports ARC function.

5. Ground Switch

Note: The ground switch position should be set to 1 as default. Use another position if a humming noise occurs.

Position 1 – Normal/default position. The main unit audio ground is lifted from chassis earth.

Position 2 – Main unit audio ground is connected directly to chassis earth. For some setups, this can reduce hum or noise when certain TVs, Turntables, and other equipment are connected to the Evo unit

6. USB Media

For connecting local media storage. Note that the USB ports are not intended for connection to Apple mobile devices; no functionality, charging or otherwise is supported.

7. Ethernet

Use a wired connection for seamless playback of high-resolution 352.8kHz, 384kHz, and DSD 256.

8. IR In

Receives modulated IR commands from an IR repeater or custom install systems.

9. Digital Inputs (Coax and Optical)

Note: If a digital input is connected to a TV you can enable TV mode in the input settings of the StreamMagic app. This mode minimises lip-sync delays on the audio path by bypassing MQA decoding and also reduces the chance of dropouts and glitches from some TVs.

10. Analogue Input**11. Sub-Out****12. Pre-Out**

Remote control

Last updated: February 7, 2022 03:43. Revision #3060

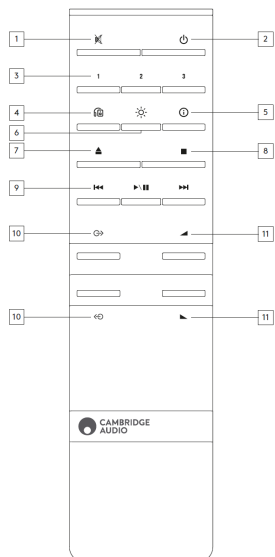

1. Mute

2. Standby/On

3. Preset buttons

Press and hold to store the current source.

Note: Not available for media player queue, AirPlay or Chromecast sources.

4. Speaker output

Press to choose a different speaker output. Pressing this button will toggle the speaker output between speaker A, speaker B, speaker A+B, headphone and Bluetooth devices.

5. Info

During playback, pressing this button will cycle through 'Now Playing' screens. Press and hold to display the product info.

6. Brightness

Pressing this button will alter the brightness of the display backlight between bright, dim and an option to switch off the backlight.

7. Eject CD (Evo CD only)

Press to eject the CD from the slot.

8. Stop (Evo CD only)

9. Play/Pause/Skip

10. Source selection

11. Volume

Replaceable side panel

Last updated: February 7, 2022 03:43. Revision #3040

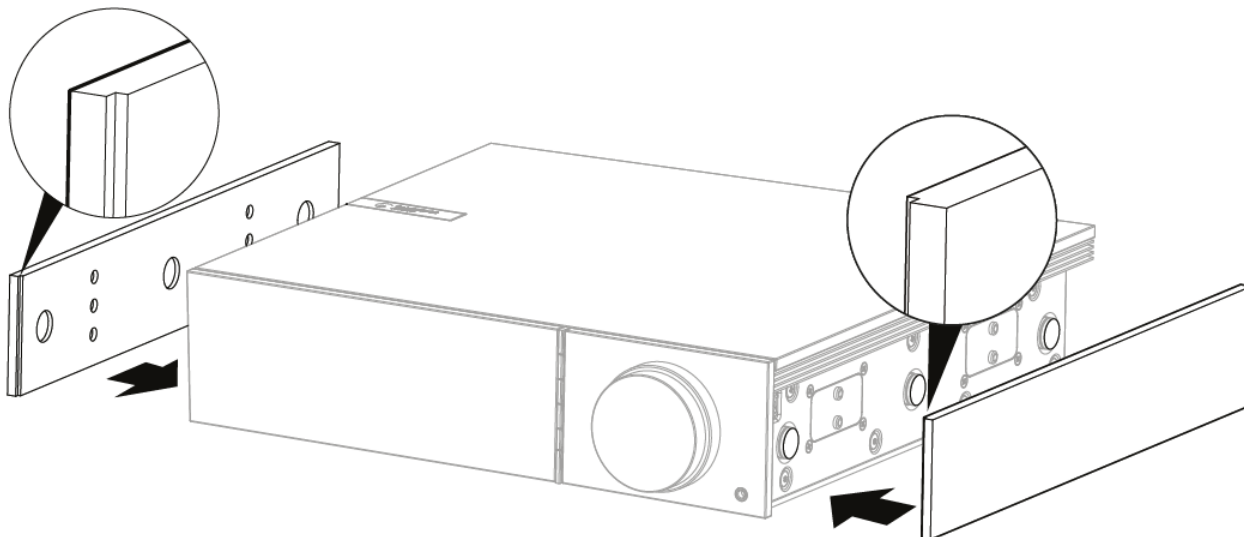

When installing new magnetic side panels, please ensure that the groove cuts are aligned with the direction of the front panel. Insert from the rear by holding the rear of the panel.

Important note: The magnets can snap hard and pinch your fingers if not done correctly.

Getting connected

Last updated: February 7, 2022 03:44. Revision #3072

Basic connections

The diagram below shows the basic connection of your Evo to a pair of loudspeakers.

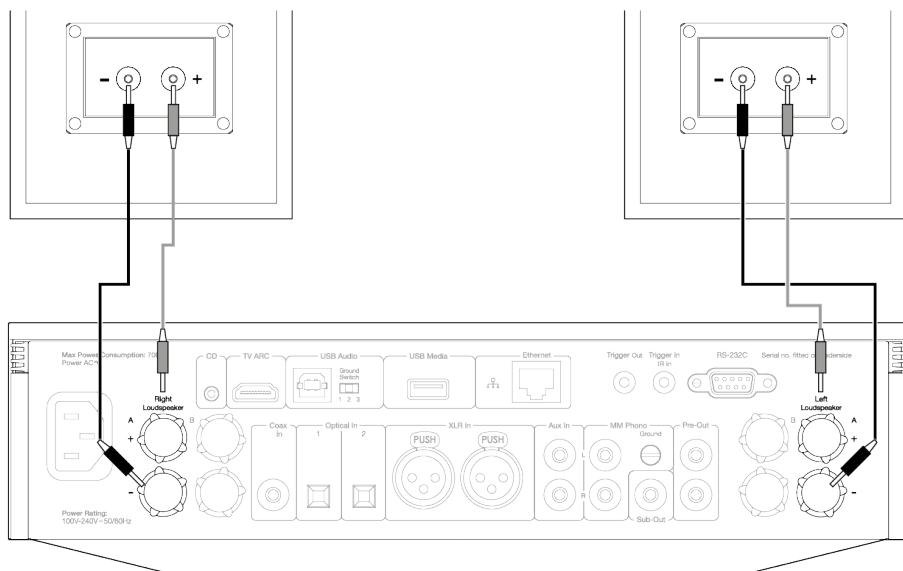

Speaker B connections (Evo 150 only)

The diagram below shows the connection for a second pair of loudspeakers. Pressing the speaker output icon will scroll through the selection of speakers, speaker A, speaker B, and speaker A and B together.

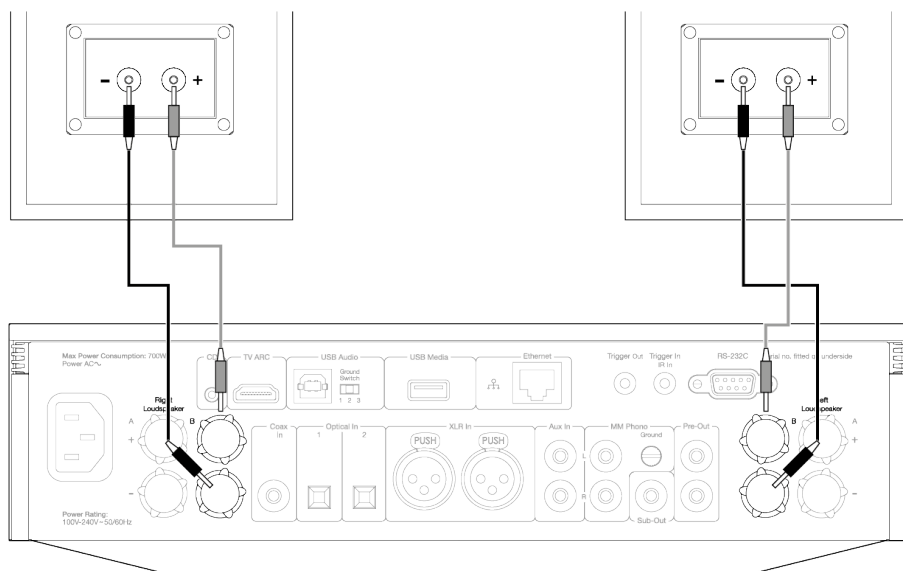

Preamp Out connections

The Preamp Out sockets are for connecting to a power amplifier or active subwoofer.

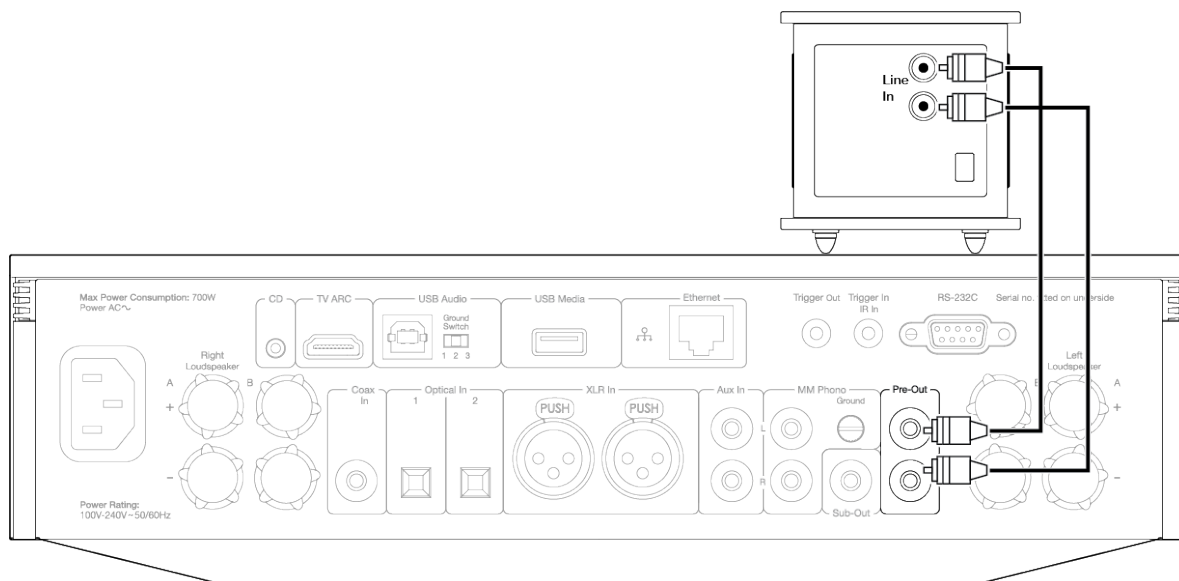

Balanced audio connections (Evo 150 only)

The diagram below shows how to connect the Evo 150 using the Balanced Audio inputs.

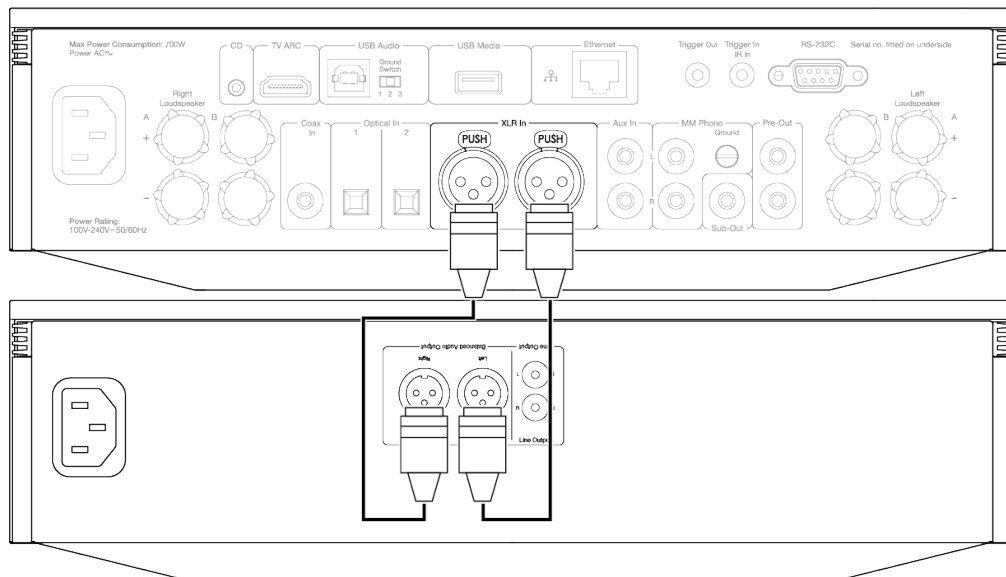

USB audio connection (Evo 150 only)

Important note: Before setting up your Evo 150 for the first time, please make sure that the USB Audio connection is unplugged. USB Audio can be re-connected once any firmware updates are applied.

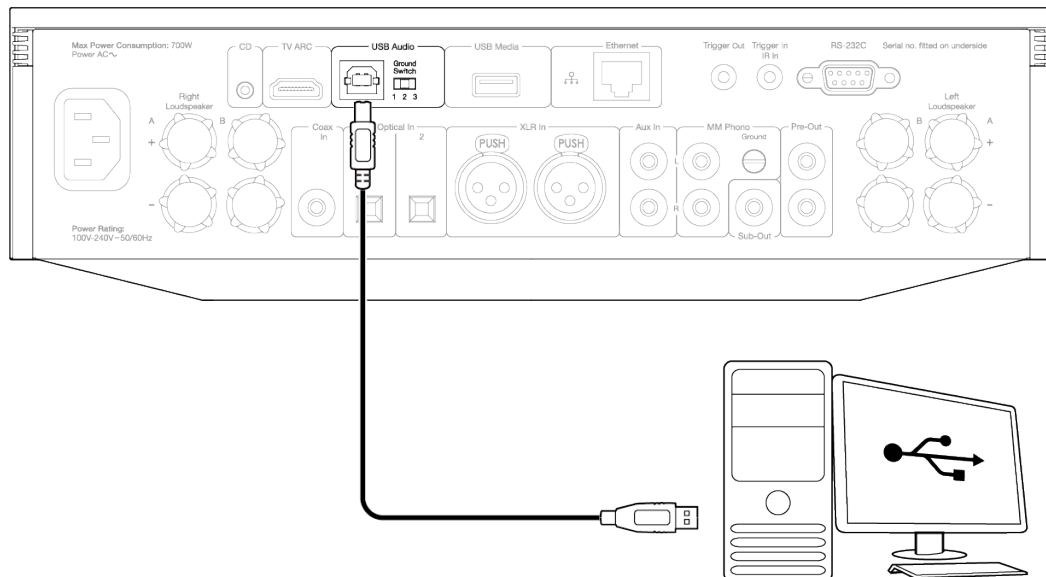

Network connections

Connecting to a wired network

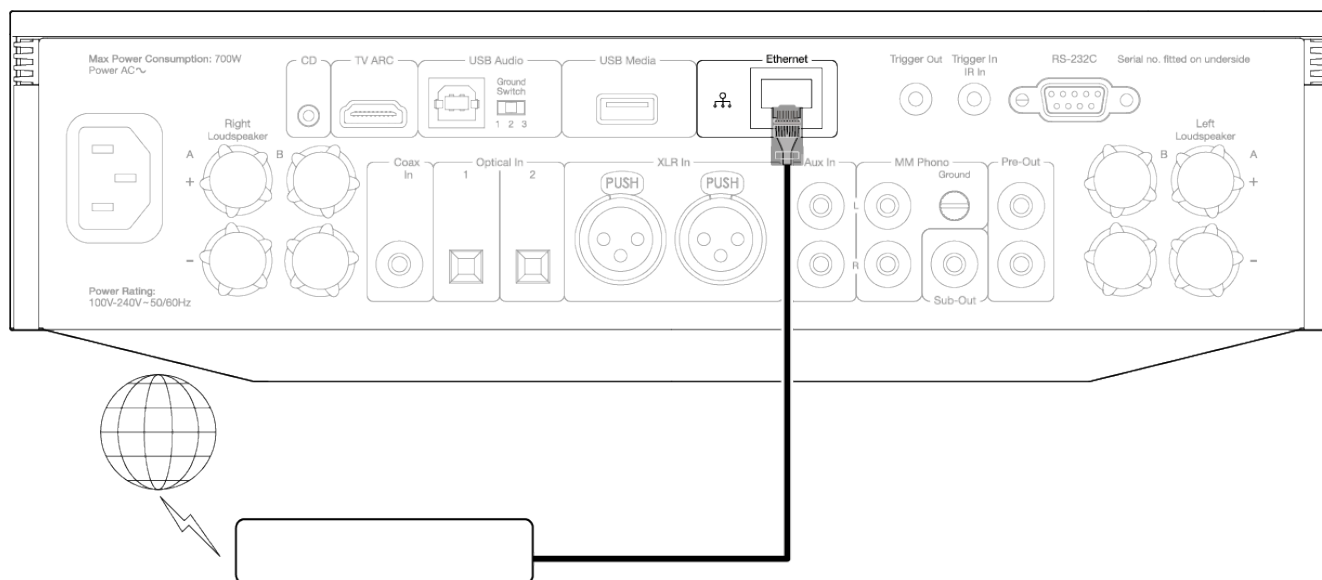

Connect a network cable between the Evo and your router.

Connecting to a wireless network

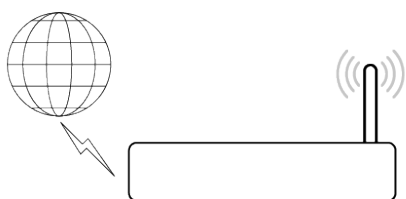
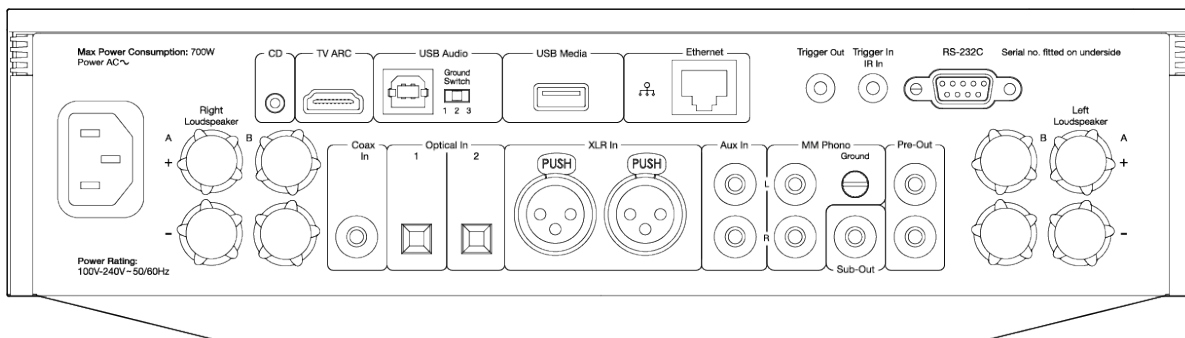

Note: Your Evo will need to be in range of your wireless router.

ARC input

Last updated: April 25, 2022 03:16. Revision #3830

The ARC function on a TV allows it to send audio and control commands to a connected audio product. This allows the TV to switch on the audio product when needed, and also to control the volume from the TV remote.

Troubleshooting

No signal shown on the front panel or no audio output from your connected product

- Make sure the HDMI input on your TV supports ARC
- Make sure the TV is set to use a connected audio system rather than its internal speakers
- Make sure that the audio output of your TV is set to 'Stereo PCM (Uncompressed)'
- Make sure your HDMI cable is compatible with HDMI 1.4 or above

TV will not switch on or control your connected product

- Make sure that 'TV Power Control' is enabled in the StreamMagic app on the ARC source settings page

Reporting an issue

If after following the above troubleshooting steps you still have a problem getting ARC to work with your product, please let us know [here](#).

StreamMagic app - Setup

Last updated: February 7, 2022 03:44. Revision #3043

Your player is network connected, not only can you listen to devices connected to the inputs on the product but you can also stream music from many different sources both on your home network and from the internet.

To set up your player, please first download the StreamMagic app from the Apple app store or Google Play store.



Set up

1. Switch on your player and follow the on screen instructions to select your preferred language.
2. Open the StreamMagic app and follow the instructions provided to complete setting up your player on your network. This process will also apply any new updates that may be pending.

Note: During the set up process you will be asked to give your player a name, please make sure this is unique to your player. This will make it easier to find when using streaming and smart home services.

Once your player is connected to your home network you'll have full control of your sources, including internet radio, streaming services, network and USB drives and more.

For more information on our StreamMagic app, please visit: <https://www.cambridgeaudio.com/streammagic>

Google Home / Chromecast built-in

Last updated: January 24, 2022 03:01. Revision #3044

Your player is network connected, not only can you listen to devices connected to the inputs on the product but you can also stream music from many different sources both on your home network and from the internet.

Your player features Chromecast built-in and can be incorporated in to your Google Home. To set up your player, download the Google Home app on your smart phone or tablet.



With Chromecast built into your player, your phone becomes your remote. Simply tap the Cast button from apps you already know and love to stream music, podcasts and playlists from your phone, tablet or laptop to your player.

Chromecast built-in

Your phone is your remote

- Simply tap the Cast button from apps you already know and love. No new logins or downloads required.
- Use your phone to search, play, pause and turn up the volume from anywhere in the home.
- While you're streaming, you can keep using your phone for other things - scroll through social media, send a text, and even accept calls.
- Enjoy music throughout your house when you use multi-room casting with Chromecast-enabled speakers.
- Just say "Hey Google" to cast to your player

Unlimited entertainment, all on your schedule

- Works with hundreds of apps and new apps are being added all the time.
- Choose from millions of songs from popular music services like Pandora, Spotify, and Youtube Music.

Android, Google Play and the Chromecast built-in logo are trademarks of Google Inc.

Bluetooth source

Last updated: February 7, 2022 03:46. Revision #3046

The Bluetooth source allows your player to receive wireless Bluetooth audio from most phones, tablets and laptops.

Pairing

To begin streaming high-quality music from your chosen media source it will first need to be paired with your player.

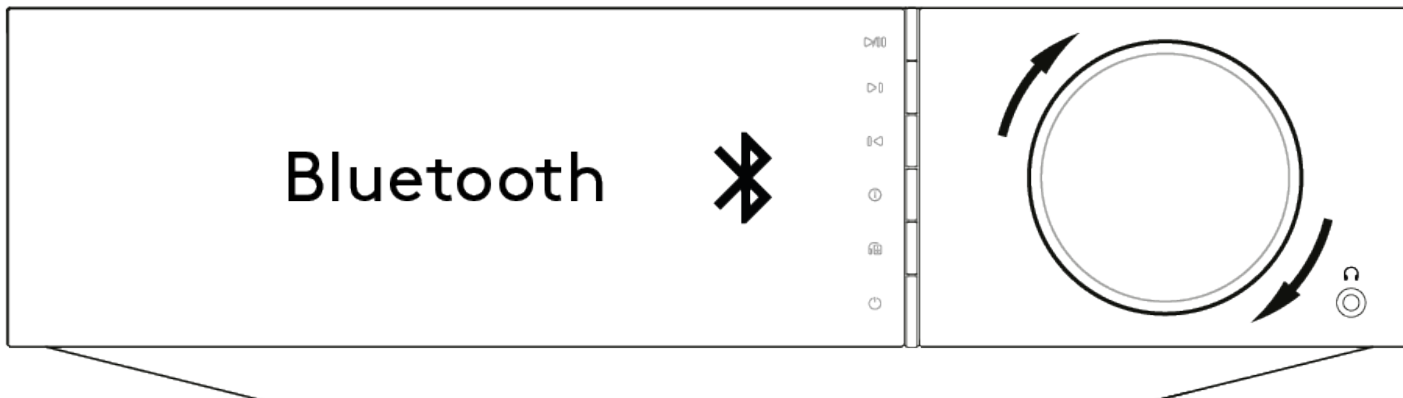

1. Select the Bluetooth source on your player
2. Open your mobile device or laptops Bluetooth settings
3. Select your player from the list of available devices
4. Your device should now connect to your player

Once paired you should be able to connect to your player at any time by selecting the Bluetooth source on your player and then choosing your player from the list of previously connected devices.

Notes:

- Your Bluetooth device can only be connected to your player while the Bluetooth source is selected.
- The Bluetooth source cannot be used if listening on Bluetooth headphones via the Output Select feature.

AirPlay

Last updated: January 24, 2022 03:02. Revision #3047

AirPlay is an Apple technology designed to control home audio systems and speakers in any room — with a tap or by just asking Siri — right from iPhone, iPad, HomePod, or Apple TV. Play a song in the living room and kitchen at the same time or adjust the volume in any room, all in sync.

After installing your player, add it to the Apple Home app with a few simple steps using your iPhone or iPad

How to use AirPlay from iPhone or iPad

1. Ensure your player is connected to your network.
2. Open the app that you want to AirPlay from.

3. Tap  or .

4. Select your player as your AirPlay device.

How to use AirPlay from Control Center

To switch the audio on your device from Control Center: Swipe up from the bottom edge of any screen on your device to open Control Center.

Touch and hold  in the upper-right corner, then select your player.

This product supports AirPlay 2 and requires iOS 11.4 or later.

Apple and AirPlay are trademarks of Apple Inc., registered in the U.S. and other countries.

Use of the Works with Apple badge means that an accessory has been designed to work specifically with the technology identified in the badge and has been certified by the developer to meet Apple performance standards.

Spotify Connect

Last updated: January 24, 2022 03:02. Revision #3063

Use your phone, tablet or computer as a remote control for Spotify.

Go to spotify.com/connect to learn how.

The Spotify Software is subject to third party licenses found here: www.spotify.com/connect/third-party-licenses

Bluetooth output

Last updated: February 7, 2022 03:46. Revision #3064

Your player supports Bluetooth output. This means you can send the audio from your player, wirelessly to Bluetooth headphones or a Bluetooth speaker.

Pairing

If you haven't connected your player to a Bluetooth device previously you'll need to use the StreamMagic app.

1. Make sure your Bluetooth device is set to pairing mode (see your Bluetooth device instructions for how to do this).
2. Open the StreamMagic app.
3. Tap select output on the home page.
4. Select Pair new Bluetooth device.
5. Select your Bluetooth device from the list of available devices.

Your player will now switch its audio output to playback on your Bluetooth device.

Once paired your Bluetooth device will be remembered by your player.

To switch audio output to a Bluetooth device

Make sure your Bluetooth device is switched on and ready to connect.

either:

1. Open the StreamMagic app.
2. Tap Select Output on the Home page.
3. Choose your Bluetooth device.

or

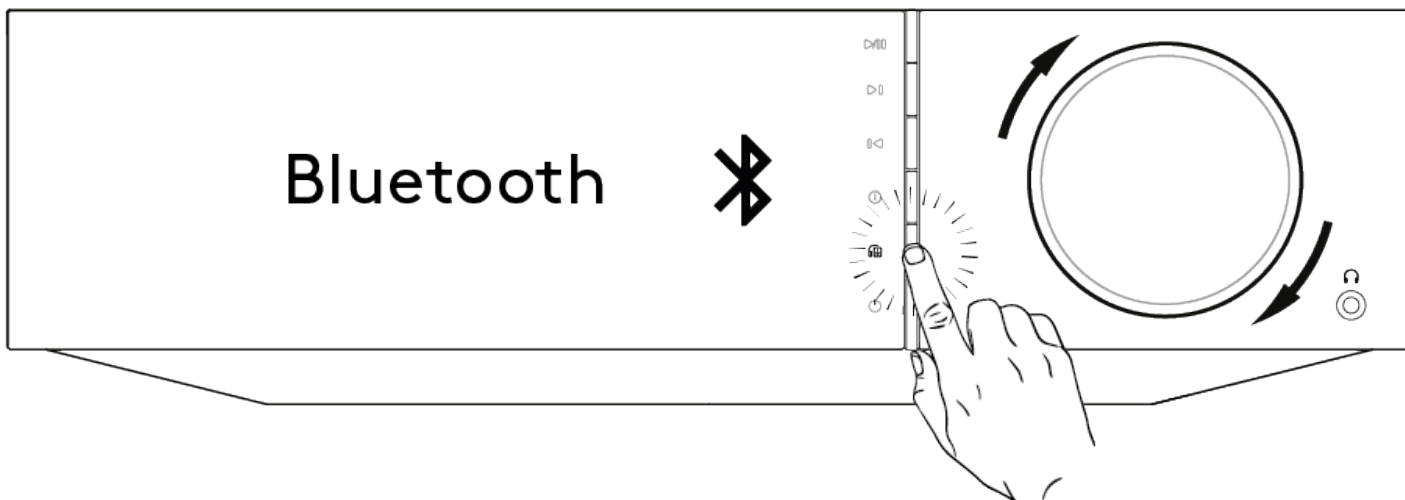

1. Press the Output select button on the remote or front panel.
2. Choose your Bluetooth device from the list.

To switch audio away from the Bluetooth device

either:

- Switch off or disconnect your Bluetooth device.

or

- Choose a different output from either the StreamMagic app or by pressing the output select button on the remote or front panel.

Notes:

- Audio cannot be output to a Bluetooth device if the Bluetooth source is currently selected.
- Please use the volume controls on your Bluetooth headphones.

MQA (Master Quality Authenticated)

Last updated: January 24, 2022 03:03. Revision #3066

The Cambridge Audio EVO includes MQA technology, which enables you to play back MQA audio files and streams, delivering the sound of the original master recording.

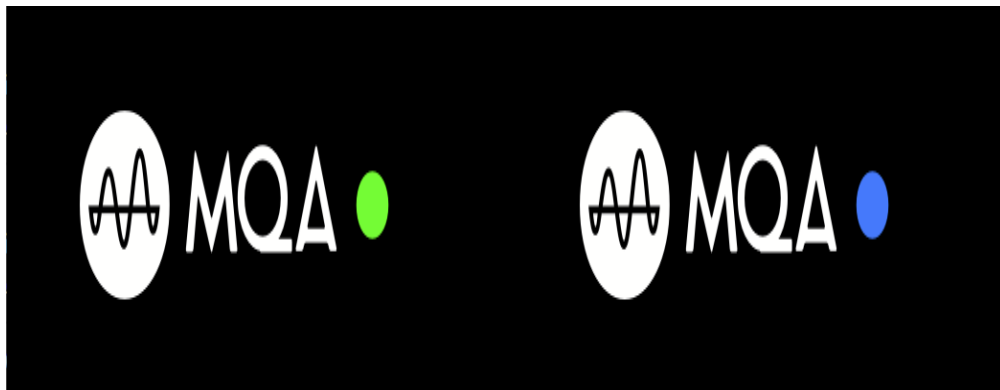

The front panel will display MQA green or blue to indicate that the unit is decoding and playing an MQA stream or file, and denotes provenance to ensure that the sound is identical to that of the source material. It displays MQA blue to indicate it is playing an MQA Studio file, which has either been approved in the studio by the artist/producer or has been verified by the copyright owner.

Settings

Last updated: February 7, 2022 03:46. Revision #3050

Device Name

This is how your player will appear in your StreamMagic app and on your home network when using services like Spotify, Chromecast built-in and TIDAL Connect.

Giving your player a unique name makes it easier to distinguish when using streaming and smart home services.

AirPlay Name

This is how your player will appear when using AirPlay or the Apple Home app.

Standby Mode

This selects what type of standby mode your player will use.

Network Standby means your player will still be controllable by the StreamMagic app and other network services.

If Eco mode is chosen your player will use even less power in standby but will need to be switched on either by the front panel or the remote control.

Automatic Power Down

This sets how long your player will wait while inactive before switching in to standby.

Display Brightness

This sets the brightness of your player's display. If set to 'Off' the display will show for a few seconds after any change and then switch off.

USB Audio Class

This sets the USB Audio Class for the USB Audio input.

USB Audio Class 1.0 (default) works with USB 1.1 ports and supports up to 24-bit/96kHz.

USB Audio Class 2.0 requires a USB 2.0 port and can support up to 32-bit/384kHz (asynchronous) and up to DSD-256. Depending on your PC or laptop you may require an additional driver.

For more info about USB Audio see our [online guide](#).

Tone Control*

We've tuned Evo to deliver Great British Sound, however we realise how personal and subjective listening can be so we've added a digital tone control to allow you to tailor the sound of Evo to your own preference.

If you'd rather leave your sound untouched, you can disable the tone control completely and audio will bypass all processing, leaving Evo performing exactly as we tuned it.

Note: Tone control will not affect DSD streams and will not be present on Bluetooth output.

Volume Limit

This sets the maximum volume that other streaming services like AirPlay, Spotify, TIDAL Connect and Chromecast built-in can set. The front panel, remote control and StreamMagic app volume controls can override this setting.

Early Update

Setting this to 'On' will let you try out the latest firmware ahead of general release.

For more information and to find out what's new visit our [FAQ](#).

Firmware

This will check for and apply any new firmware available for your player.

You can also check for new updates on the info screen.

When left in network standby overnight your player will check and apply any new updates.

Factory Reset

This will return your player to its factory settings.

You can also do this from the info screen.

Note: Your network player must be connected to the internet to carry out firmware updates. It is recommended that you keep your network player connected to ensure optimal performance.

*Requires software version 124-a-018 or higher

Info screen

Last updated: February 7, 2022 03:47. Revision #3051

The info screen shows useful information about your player, it also allows you to carry out some actions to help resolve problems with your player.

To access the info screen hold the ⓘ button on the front panel for 2 seconds

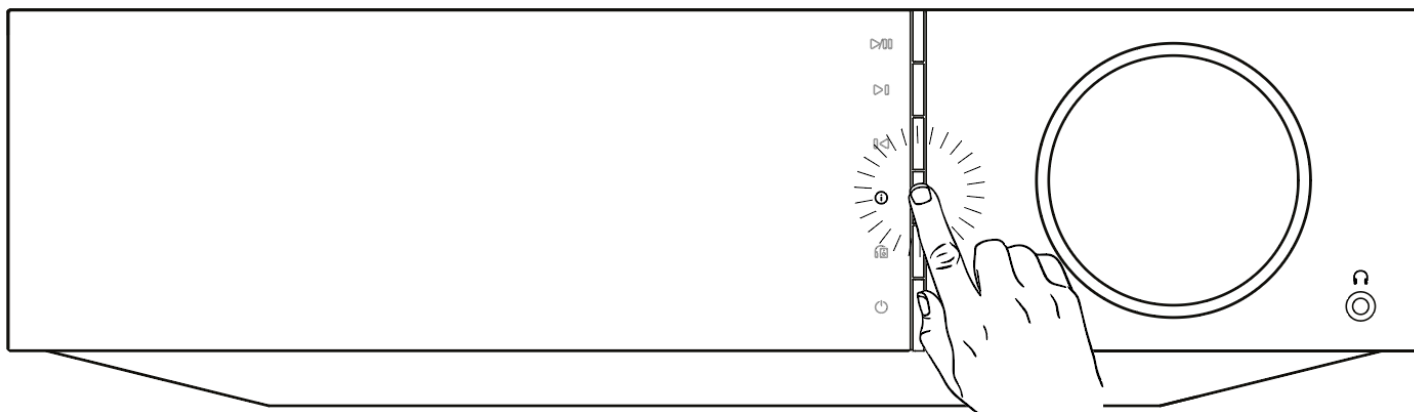

Technical specifications

Last updated: February 7, 2022 03:47. Revision #4562

Evo 75

POWER OUTPUT

75W into 8 Ohms

AMPLIFICATION

Class-D

DAC

ESS Sabre ES9016K2M

FREQUENCY RESPONSE

20Hz -20kHz +/-3dB

ANALOGUE AUDIO INPUTS

1 x RCA

DIGITAL AUDIO INPUTS

1 x TOSLINK optical, 1 x S/PDIF coaxial, Bluetooth (integrated), 1 x TV ARC

Bluetooth: 4.2 A2DP/AVRCP supporting SBC, aptX and aptX HD codecs

COMPATIBILITY

TOSLINK optical: 16/24bit 44.1-96kHz PCM only

S/PDIF coaxial: 16/24bit 44.1-192kHz PCM only

ARC: 16/24bit 44.1-192kHz PCM only

UPnP, Local USB media, Airplay 2, Chromecast built-in, Internet Radio, Spotify Connect, TIDAL, Qobuz, Amazon Music, RoonReady.

AUDIO FORMATS

ALAC, WAV, FLAC, AIFF, DSD (x256), WMA, MP3, AAC, HE AAC AAC+, OGG Vorbis

OUTPUTS

Speakers, 3.5mm headphone, Preamp Output, Subwoofer Output, Bluetooth (integrated)

Bluetooth: 4.2 A2DP/AVRCP supporting up to aptX HD

ETHERNET

IEEE 802.3, 10 Base-T or 100 Base-T

WI-FI

Dual-Band 2.4/5GHz

MAX POWER CONSUMPTION

400W

STANDBY POWER CONSUMPTION

<0.5W

DIMENSIONS (W x H x D)

317 x 89 x 352 mm

WEIGHT

5Kg

Evo 150

POWER OUTPUT

150W into 8 Ohms

AMPLIFICATION

Class-D

DAC

ESS Sabre ES9018K2M

FREQUENCY RESPONSE

20Hz -20kHz +/-3dB

ANALOGUE AUDIO INPUTS

1 x RCA, 1 x Balanced XLR, 1 x MM Phono

DIGITAL AUDIO INPUTS

2 x TOSLINK optical, 1 x S/PDIF coaxial, Bluetooth (integrated), 1 x TV ARC, USB Audio

USB Audio: USB Type B conforming to USB Audio Class 1 or USB Audio Class 2 (user selectable)

Bluetooth: 4.2 A2DP/AVRCP supporting SBC, aptX and aptX HD codecs

COMPATIBILITY

TOSLINK optical: 16/24bit 44.1-96kHz PCM only

S/PDIF coaxial: 16/24bit 44.1-192kHz PCM only

ARC: 16/24bit 44.1-192kHz PCM only

USB Audio Class 1: Up to 24-bit 96kHz (asynchronous)

USB Audio Class 2: Up to 32 bit 384kHz (asynchronous) and up to DSD-256

UPnP, Local USB media, Airplay 2, Chromecast built-in, Internet Radio, Spotify Connect, TIDAL, Qobuz, Amazon Music, RoonReady.

Note: USB media maximum current 1A

AUDIO FORMATS

ALAC, WAV, FLAC, AIFF, DSD (x256), WMA, MP3, AAC, HE AAC AAC+, OGG Vorbis

OUTPUTS

Speakers A+B, 3.5mm headphone, Preamp Output, Subwoofer Output, Bluetooth (integrated)

Bluetooth: 4.2 A2DP/AVRCP supporting up to aptX HD

ETHERNET

IEEE 802.3, 10 Base-T or 100 Base-T

WI-FI

Dual-Band 2.4/5GHz

MAX POWER CONSUMPTION

700W

STANDBY POWER CONSUMPTION

<0.5W

DIMENSIONS (W x H x D)

317 x 89 x 352 mm

WEIGHT

5.3Kg

Troubleshooting

Last updated: June 6, 2022 09:05. Revision #4542

If you experience any trouble with your Evo, visit the help section on our webpage at <http://techsupport.cambridgeaudio.com>

If you have trouble connecting the Evo to your network, these steps may help to resolve the problem:

- Confirm that a connected computer can access the Internet (i.e. can browse the web) using the same network.
- If you have an encrypted Wi-Fi network, check that you have entered the correct key or passphrase. Remember that text-format keys are case-sensitive.

If your Evo can connect to the network successfully but is unable to play particular Internet Radio stations, it may be due to one of the following causes:

- The station is not broadcasting at this time of the day (remember it may be located in a different time zone).
- The station has reached the maximum allowed number of simultaneous listeners.
- The station is not broadcasting anymore.
- The Internet connection between the server (often located in a different country) and you is too slow.

If you have problems with UPnP playback check the following:

- Ensure your chosen UPnP server software is capable of serving the file type you are trying to access. Some servers do not serve FLAC for instance.
- Evo can only play non DRM files. Files that have DRM controls cannot be played by Evo. Some servers may be able to authorise and de-encrypt Microsoft PlaysForSure before then serving the content to Evo, but this operation is not guaranteed as it is purely a function of the server.
- If attempting to play 24-bit WAV or FLAC content a wired Ethernet connection is normally required for reliable operation due to bandwidth considerations.
- Check Evo is capable of playing back the file type you are trying to access.

If you have problems with USB Media playback check the following:

- Check Evo is capable of playing back the file type you are trying to access.
- For USB Media Evo can only play non DRM files. Files that have DRM controls cannot be played.
- Check that your device does not require more than 1A if it is powered from the USB socket itself.
- Check your device format is supported by Evo.
- The way you organise your USB media affects how efficiently Evo can browse the content. A good practice is to create folders for Artists within which you should have subfolders for each Album which then contain the tracks for that Album. Libraries with thousands of tracks in one folder will progressively slow down Evo's media browsing.

A TV connected to a digital input has dropouts, glitches or disrupted audio.

- Some TVs have been found to have issues on digital inputs. Enabling TV mode in the StreamMagic app for the digital input connected to a TV should reduce the chance of audio issues from the TV.

MQA tracks do not display as MQA on the front panel.

- If you are using one of the digital inputs, check that TV Mode is disabled.

There is no power:

- Ensure the AC power cord is connected securely.
- Ensure the plug is fully inserted into the wall socket and is switched on.
- Check fuse in the mains plug or adaptor.

There is no sound:

- Make sure the unit is not in Standby mode.
- Check that the source component is properly connected.
- Check that your speakers are properly connected.
- Make sure Evo is not in mute mode.

There is no sound on one channel:

- Check speaker connections.
- Check interconnects.

There is a loud buzz or hum:

- Ensure no interconnects are loose or defective.

There is weak bass or diffused stereo imaging:

- Ensure that speakers are not wired out of phase.

The remote handset will not function:

- Check that the batteries have not expired.
- Ensure that nothing is blocking the remote sensor.