

BOSE

PROFESSIONAL



ControlSpace

EX-1280
EX-440C
EX-1280C
EX-12AEC

Installation & Operation Guide
Guía de instalación y funcionamiento
Guide d'installation et d'utilisation
Installations- und Bedienungsanleitung
Manuale di installazione e funzionamento
Installatie- en bedieningshandleiding

Please read and keep all safety, security and use instructions.

This product is intended for installation by professional installers only! This document is intended to provide professional installers with basic installation and safety guidelines for this product in typical fixed-installation systems. Please read this document and all safety warnings before attempting installation. Do not attempt to service this product yourself. Refer all servicing to authorized service centers, installers, technicians, dealers or distributors. To contact Bose Professional or to find a dealer or distributor near you, visit BoseProfessional.com. The product label is located on the bottom of the product.

Important Safety Instructions

1. Read these instructions.
2. Keep these instructions.
3. Heed all warnings.
4. Follow all instructions.
5. Do not use this apparatus near water.
6. Clean only with a dry cloth.
7. Do not block any ventilation openings. Install in accordance with the manufacturer's instructions.
8. Do not install near any heat sources such as radiators, heat registers, stoves, or other apparatus (including amplifiers) that produce heat.
9. Do not defeat the safety purpose of the polarized or grounding-type plug. A polarized plug has two blades with one wider than the other. A grounding type plug has two blades and a third grounding prong. The wide blade or the third prong are provided for your safety. If the provided plug does not fit into your outlet, consult an electrician for replacement of the obsolete outlet.
10. Protect the power cord from being walked on or pinched particularly at plugs, convenience receptacles, and the point where they exit from the apparatus.
11. Only use attachments/accessories specified by the manufacturer.
12. Unplug this apparatus during lightning storms or when unused for long periods of time.
13. Refer all servicing to qualified personnel. Servicing is required when the apparatus has been damaged in any way, such as power-supply cord or plug is damaged, liquid has been spilled or objects have fallen into the apparatus, the apparatus has been exposed to rain or moisture, does not operate normally, or has been dropped.

WARNINGS/CAUTIONS



This symbol on the product means there are important operating and maintenance instructions in this guide.



This symbol on the product means there is uninsulated, dangerous voltage within the product enclosure that may present a risk of electrical shock.



WARNING: All Bose Professional products must be installed in accordance with local, state, federal and industry regulations. It is the installer's responsibility to ensure installation of the loudspeakers and mounting system is performed in accordance with all applicable codes, including local building codes and regulations. Consult the local authority having jurisdiction before installing this product.



WARNING: Unsafe mounting or overhead suspension of any heavy load can result in serious injury or death, and property damage. It is the installer's responsibility to evaluate the reliability of any mounting method used for their application. Only professional installers with the knowledge of proper hardware and safe mounting techniques should attempt to install any loudspeaker overhead.



WARNING: To reduce the risk of fire or electrical shock, do NOT expose this product to rain, liquids or moisture.



WARNING: Do not mount the product in locations where condensation may occur.



WARNING: This product is not intended for installation or use in indoor water facility areas (including, without limitation, indoor pools, indoor water parks, hot tub rooms, saunas, steam rooms and indoor skating rinks).



WARNING: Do NOT make unauthorized alterations to this product.



WARNING: Do NOT use in vehicles or boats.



WARNING: Use this product only with the power supply provided.



WARNING: Where the mains plug or an appliance coupler is used as the disconnect device, the disconnect device shall remain readily operable.



WARNING: Provide an earth connection or ensure the socket outlet incorporates a protective earthing connection before connecting the plug to the mains socket outlet.
 Dansk: Apparatets stikprop skal tilsluttes en stikkontakt med jord, som giver forbindelse til stikproppens jord.
 Suomi: Laite on liitettävä suojamaadoitusoskettimilla varustettuun pistorasiaan.
 Norsk: Apparatet må tilkoples jorden stikkontakt.
 Svenska: Apparaten skall anslutas till jordat uttag.



WARNING: The speaker wire and interconnect cables included with this system are not approved for in-wall installation. Please check your local building codes for the correct type of wire and cable required for in-wall installation.



WARNING: Do not expose products containing batteries to excessive heat (e.g. from storage in direct sunlight, fire or the like).



WARNING: The battery provided with this product may present a risk of fire or chemical burn if mishandled.



WARNING: Contains small parts which may be a choking hazard. Not suitable for children under age 3.



WARNING: Do not use hydrocarbon-based solvents, lubricants or cleaning agents of any type on or around Bose Professional speakers, and associated mounting hardware, during installation. The use of such hydrocarbon based lubricants, solvents or cleaning agents on or around the mounting anchors and screws can lead to degradation of the plastic material, possibly resulting in cracking and premature failure of the product.



CAUTION: Keep the product away from fire and heat sources. Do NOT place naked flame sources, such as lighted candles, on or near the product.



CAUTION: To reduce the risk of fire, use only No. 26 AWG (0.41 mm Ø / 0.13 mm²) or larger telecommunication line cord.



CAUTION: Only use the mounting hardware recommended by the rack manufacturer.



CAUTION: Due to ventilation requirements, Bose Professional does not recommend placing the product in a confined space such as in a wall cavity or in an enclosed cabinet.



CAUTION: Do not place or install the bracket or product near any heat sources, such as fireplaces, radiators, heat registers or other apparatus (including amplifiers) that produce heat

Regulatory Information

CAN ICES-3(A)/NMB-3(A)

This product complies with the Canadian ICES-003 Class A specifications.

This device complies with part 15 of the FCC Rules and with Industry Canada license-exempt RSS standard(s). Operation is subject to the following two conditions: (1) This device may not cause harmful interference, and (2) this device must accept any interference received, including interference that may cause undesired operation.

Note: This equipment has been tested and found to comply with the limits for a Class A digital device, pursuant to part 15 of the FCC Rules. These limits are designed to provide reasonable protection against harmful interference when the equipment is operated in a commercial environment. This equipment generates, uses, and can radiate radio frequency energy and, if not installed and used in accordance with the instruction manual, may cause harmful interference to radio communications. Operation of this equipment in a residential area is likely to cause harmful interference in which case the user will be required to correct the interference at their own expense.

Changes or modifications not expressly approved by Bose Professional could void the user's authority to operate this equipment.

This is a class A product. In a domestic environment this product may cause radio interference in which case the user may be required to take adequate measures.



This product conforms to all applicable EU directive requirements. The complete declaration of conformity can be found at www.Bose.com/compliance.



This product conforms to all applicable Electromagnetic Compatibility Regulations 2016 and all other applicable UK regulations. The complete declaration of conformity can be found at: www.Bose.com/compliance



This symbol means the product must not be discarded as household waste, and should be delivered to an appropriate collection facility for recycling. Proper disposal and recycling helps protect natural resources, human health and the environment. For more information on disposal and recycling of this product, contact your local municipality, disposal service, or the shop where you bought this product.

This product meets all EN55103-2 immunity requirements for E2 electromagnetic environment. Shielded cables are required to maintain regulatory compliance.

Product Ratings:

Input Voltage:	100 VAC-240 VAC
Frequency:	50/60 Hz
Current or Power:	60 W maximum
Initial turn-on inrush current:	20 A at 120 V; 38 A at 230 V

China Restriction of Hazardous Substances Table

Names and Contents of Toxic or Hazardous Substances or Elements						
Part Name	Toxic or Hazardous Substances and Elements					
	Lead (Pb)	Mercury (Hg)	Cadmium (Cd)	Hexavalent (CR(VI))	Polybrominated Biphenyl (PBB)	Polybrominated diphenylether (PBDE)
PCBs	X	0	0	0	0	0
Metal Parts	X	0	0	0	0	0
Plastic Parts	0	0	0	0	0	0
Speakers	X	0	0	0	0	0
Cables	X	0	0	0	0	0

This table is prepared in accordance with the provisions of SJ/T 11364.
 0: Indicates that this toxic or hazardous substance contained in all of the homogeneous materials for this part is below the limit requirement of GB/T 26572.
 X: Indicates that this toxic or hazardous substance contained in at least one of the homogeneous materials used for this part is above the limit requirement of GB/T 26572.



Taiwan Restriction of Hazardous Substances Table

Equipment names: EX-440C, EX-1280, EX-1280C, EX-12AEC. **Type designations:** 834315, 834316, 834317, 834351, 834352, 834354

Unit	Restricted substances and its chemical symbols					
	Lead (Pb)	Mercury (Hg)	Cadmium (Cd)	Hexavalent chromium (Cr+6)	Polybrominated biphenyls (PBB)	Polybrominated diphenyl ethers (PBDE)
PCBs	-	o	o	o	o	o
Metal Parts	-	o	o	o	o	o
Plastic Parts	o	o	o	o	o	o
Speakers	-	o	o	o	o	o
Cables	-	o	o	o	o	o

Note 1: "o" indicates that the percentage content of the restricted substance does not exceed the percentage of reference value of presence.
Note 2: The "-" indicates that the restricted substance corresponds to the exemption.

Date of Manufacture: The eighth digit in the serial number indicates the year of manufacture; "3" is 2013 or 2023.

China Importer: Bose Electronics (Shanghai) Company Limited, Level 6, Tower D, No. 2337 Gudai Rd. Minhang District, Shanghai 201100

UK Importer: Bose Limited Bose House, Quayside Chatham Maritime, Chatham, Kent, ME4 4QZ, United Kingdom

EU Importer: Bose Products B.V., Gorslaan 60, 1441 RG Purmerend, The Netherlands

Mexico Importer: Bose de México, S. de R.L. de C.V., Paseo de las Palmas 405-204, Lomas de Chapultepec, 11000 México, D.F. For importer & service information: +5255 (5202) 3545

Taiwan Importer: Bose Taiwan Branch, 9F-A1, No. 10, Section 3, Minsheng East Road, Taipei City 104, Taiwan. Phone Number: +886-2-2514 7676

Bose Corporation, Framingham, MA 01701, U.S.A. 1-877-230-5639

Bose is a trademark of Bose Corporation. ControlSpace is a trademark of Transom Post OpCo LLC. AMX is a trademark of AMX Corporation. Arm is a registered trademark of Arm Limited (or its subsidiaries) in the US and/or elsewhere. Crestorn® is a registered trademark of Crestorn Electronics, Inc. Dante™ is a trademark of Audinate Pty Ltd. All other trademarks are the property of their respective owners.

©2023 Transom Post OpCo LLC. No part of this work may be reproduced, modified, distributed or otherwise used without prior written permission.

Warranty Information

This product is covered by a limited warranty. For warranty details, visit BoseProfessional.com/Warranty.

Lea y conserve todas las instrucciones de uso y seguridad.**Este producto está diseñado para ser instalado únicamente por instaladores profesionales.**

Este documento está diseñado para proveer las pautas de seguridad e instalación básicas a los instaladores profesionales de este producto en sistemas de instalación fija comunes. Lea este documento y todas las advertencias de seguridad antes de comenzar la instalación.

No intente reparar este producto por su cuenta. Remita todas las reparaciones a centros de servicio, instaladores, técnicos o distribuidores autorizados. Para comunicarse con Bose Professional o para encontrar un distribuidor cerca de usted, visite BoseProfessional.com.

La etiqueta del producto se encuentra en la parte inferior.

Instrucciones importantes de seguridad

1. Lea estas instrucciones.
2. Guarde estas instrucciones.
3. Preste atención a las advertencias.
4. Siga todas las instrucciones.
5. No use este aparato cerca del agua.
6. Límpiolo solamente con un paño seco.
7. No obstruya ninguna abertura de ventilación. Realice la instalación conforme a las instrucciones del fabricante.
8. No lo instale cerca de una fuente de calor, como radiadores, rejillas de calefacción, estufas u otros aparatos (incluidos los amplificadores) que produzcan calor.
9. No anule el propósito de seguridad del enchufe con conexión a tierra o polarizado. Un enchufe polarizado tiene dos hojas, una más ancha que la otra. Un enchufe con conexión a tierra tiene dos clavijas planas y un tercer conector a tierra. La clavija plana más ancha o el tercer conector son para su seguridad. Si el enchufe suministrado no encaja en la toma de corriente, consulte con un electricista para cambiar la toma de corriente obsoleta.
10. Proteja el cable de alimentación para que nadie lo pise o lo perforo, especialmente en enchufes, receptáculos de tomas múltiples y en el punto donde sale del dispositivo.
11. Use solamente los accesorios especificados por el fabricante.
12. Desenchufe este aparato durante tormentas eléctricas o cuando no lo utilice durante períodos prolongados.
13. Derive todas las tareas de mantenimiento a personal calificado. Se requieren tareas de mantenimiento si el aparato se daña de alguna manera; por ejemplo, si se daña el enchufe o el cable de alimentación, si se derrama líquido o si caen objetos dentro del aparato, si se expone el aparato a la lluvia o la humedad, si no funciona normalmente o si se ha caído.

ADVERTENCIAS/PRECAUCIONES:

Este símbolo en el producto indica que en esta guía se incluyen instrucciones de mantenimiento y funcionamiento importantes.



Este símbolo en el producto indica que hay voltaje peligroso y sin aislamiento dentro de la carcasa del producto, lo cual podría representar un riesgo de descarga eléctrica.



ADVERTENCIA: Todos los productos Bose Professional deben instalarse conforme a las leyes locales, estatales, federales y del sector. Es responsabilidad del instalador garantizar que la instalación del sistema de soporte y los altavoces se realice conforme a los códigos aplicables, incluidos los códigos y las reglamentaciones de construcción locales. Consulte a la autoridad local competente antes de instalar este producto.



ADVERTENCIA: El montaje inseguro o la suspensión en alturas de cualquier carga pesada puede provocar lesiones graves o la muerte, además de daños a la propiedad. Es responsabilidad del instalador evaluar la confiabilidad de cualquier método de montaje utilizado para su aplicación. Únicamente los instaladores profesionales con conocimiento de las herramientas adecuadas y las técnicas de montaje seguro deberían intentar instalar cualquier altavoz en altura.



ADVERTENCIA: Para reducir el riesgo de incendio o descarga eléctrica, NO exponga este producto a la lluvia, líquidos o humedad.



ADVERTENCIA: No monte el producto en lugares donde se pueda generar condensación.



ADVERTENCIA: Este producto no se ha diseñado para instalar o utilizar en áreas acuáticas recreativas de interior (incluidas, entre otras, piscinas de interior, parques acuáticos de interior, salas de baño caliente, saunas, cuartos de vapor y pistas de patinaje de interior).



ADVERTENCIA: NO realice alteraciones no autorizadas a este producto.



ADVERTENCIA: NO lo use en vehículos o embarcaciones.



ADVERTENCIA: Use este producto solamente con la fuente de alimentación suministrada.



ADVERTENCIA: Si se utiliza la clavija de conexión de red eléctrica o el acoplador del artefacto como dispositivo de des-conexión, este deberá permanecer listo para funcionar.



ADVERTENCIA: Proporcione una conexión a tierra o asegúrese de que la toma de corriente incorpore una conexión a tierra protegida antes de conectar el enchufe a la toma de corriente de la red eléctrica.



ADVERTENCIA: El cable del altavoz y los cables de interconexión que se incluyen con este sistema no están aprobados para instalaciones en pared. Compruebe los códigos locales de edificación para verificar cuáles son los tipos correctos de alambre y cable requeridos para instalaciones en pared.



ADVERTENCIA: NO exponga productos con batería al calor excesivo (por ejemplo, no guardar en sitios con luz directa del sol, cerca de fuego o similar).



ADVERTENCIA: La batería suministrada con este producto puede presentar riesgo de incendio o quemadura química si no se manipula correctamente.



ADVERTENCIA: Contiene piezas pequeñas que pueden provocar asfixia. No recomendable para niños menores de 3 años.



ADVERTENCIA: No utilice ningún tipo de solventes, lubricantes ni productos de limpieza a base de hidrocarburos sobre los altavoces Bose Professional o los accesorios de montaje asociados durante la instalación. El uso de dichos solventes, lubricantes o productos de limpieza sobre los anclajes de montaje y los tornillos puede degradar el material plástico, lo que posiblemente ocasione grietas y fallas prematuras del producto.



PRECAUCIÓN: Mantenga el producto lejos del fuego y de fuentes de calor. NO coloque encima ni cerca del producto fuentes de llamas de fuego expuestas, como velas encendidas.



PRECAUCIÓN: Utilice únicamente los componentes físicos de montaje incluidos en este producto.



PRECAUCIÓN: Debido a los requisitos de ventilación, Bose Professional no recomienda colocar el producto en espacios reducidos como una cavidad de pared o un gabinete cerrado.



PRECAUCIÓN: No instale ni coloque el soporte ni el producto cerca de fuentes de calor, como chimeneas, radiadores, rejillas de calefacción u otros aparatos (incluidos amplificadores) que produzcan calor.

Información regulatoria**CAN ICES-3(A)/NMB-3(A)**

Este producto cumple con las especificaciones Clase A de la normativa canadiense ICES-003.

Este dispositivo cumple con la parte 15 de las reglas de la FCC y con las normas RSS sin licencia de la industria canadiense. El funcionamiento está sujeto a las siguientes dos condiciones: (1) este dispositivo no debe provocar interferencias dañinas y (2) este dispositivo debe aceptar cualquier interferencia recibida, incluida la interferencia que puede causar un funcionamiento no deseado.

Nota: Este equipo ha sido sometido a pruebas y se ha comprobado que cumple con los límites de un dispositivo digital Clase A, de acuerdo con la Parte 15 de las reglas de la FCC. Estos límites están diseñados para proporcionar una protección razonable contra interferencias perjudiciales cuando el equipo se utiliza en un entorno comercial. Este equipo genera, usa y puede irradiar energía de radiofrecuencia y, si no se instala y se usa conforme a lo indicado en el manual de instrucciones, podría causar una interferencia perjudicial a las comunicaciones de radio. El funcionamiento de este equipo en un área residencial podría llegar a provocar interferencias perjudiciales, en cuyo caso el usuario deberá corregir dichas interferencias por cuenta propia.

Los cambios o las modificaciones no aprobadas expresamente por Bose Professional podrían invalidar la autoridad del usuario para operar el equipo.

Este es un producto Clase A. En un entorno doméstico, es posible que el producto ocasione interferencia de radio, en cuyo caso el usuario puede que deba tomar las medidas adecuadas.

Este producto cumple los requisitos de todas las Directivas de la UE aplicables legalmente. Encontrará la declaración de conformidad completa en www.Bose.com/compliance.



Este producto cumple con todas las regulaciones aplicables de compatibilidad electromagnética de 2016 y todas las demás regulaciones aplicables del Reino Unido. La declaración de conformidad completa se puede encontrar en: www.Bose.com/compliance.



Este símbolo significa que el producto no debe desecharse como residuo doméstico y debe enviarse a una planta para tratamiento de residuos apropiada para su reciclado. Una eliminación y un reciclado adecuados ayudan a proteger los recursos naturales, la salud humana y el medioambiente. Para obtener más información acerca de la eliminación y el reciclado de este producto, comuníquese con su municipalidad local, un centro de servicios de desecho o la tienda donde compró este producto.

Este producto cumple con todos los requisitos de inmunidad de EN55103-2 para un entorno electromagnético E2. Se requieren cables aislados para mantener el cumplimiento de las reglamentaciones.

Especificaciones del producto:		
Voltaje de entrada:		100 VAC-240 VAC
Frecuencia:		50/60 Hz
Consumo:		60 W maximum
Corriente de irrupción inicial en encendido:		20 A @ 120 V; 38 A @ 230 V

Fecha de fabricación: El octavo dígito del número de serie indica el año de fabricación; p. ej., "3" es 2013 o 2023.

Importador en China: Bose Electronics (Shanghai) Company Limited, Level 6, Tower D, No. 2337 Gudai Rd. Minhang District, Shanghai 201100, China

Importador en el Reino Unido: Bose Limited, Bose House, Quayside Chatham Maritime, Chatham, Kent, ME4 4QZ, Reino Unido

Importador para la UE: Bose Products B.V., Gorslaan 60, 1441 RG Purmerend, Países Bajos

Importador para México: Bose de México, S. de R.L. de C.V., Paseo de las Palmas 405-204, Lomas de Chapultepec, 11000 México, D.F. Para obtener información sobre el servicio y el importador, comuníquese al: +5255 (5202) 3545

Importador para Taiwán: Bose Taiwan Branch, 9F-A1, N.º 10, Section 3, Minsheng East Road, Taipei City 104, Taiwán. Número telefónico: +886-2-2514 7676

Bose Corporation, Framingham, MA 01701, U.S.A. 1-877-230-5639

Bose es una marca comercial de Bose Corporation. ControlSpace es una marca comercial de Transom Post OpCo LLC. AMX es una marca comercial de AMX Corporation. Arm es una marca comercial registrada de Arm Limited (o sus filiales) en Estados Unidos u otros países. Crestron® es una marca comercial registrada de Crestron Electronics, Inc. Dante™ es una marca comercial de Audinate Pty Ltd. Todas las demás marcas comerciales son propiedad de sus respectivos dueños.

©2023 Transom Post OpCo LLC. Ninguna parte de este trabajo podrá reproducirse, modificarse, distribuirse ni usarse sin un permiso previo por escrito.

Información de la garantía

Este producto está cubierto con una garantía limitada.

Para obtener información sobre la garantía, visite BoseProfessional.com/Warranty.

Merci de lire et de conserver le manuel d'instruction et de respecter les consignes de sécurité.

Ce produit doit être installé par un technicien professionnel ! Ce document est destiné à fournir aux techniciens professionnels les directives de montage et de sécurité relatives à ce produit dédié à une installation fixe. Veuillez lire ce document, ainsi que l'ensemble des avertissements de sécurité avant de procéder à l'installation.

Ne tentez pas de réparer ce produit vous-même. Confiez toutes les opérations de maintenance à des centres de service, installateurs, techniciens, revendeurs ou distributeurs agréés. Pour contacter Bose Professional ou pour trouver un revendeur ou un distributeur près de chez vous, rendez-vous à l'adresse **BoseProfessional.com**.

L'étiquette d'identification du produit est située au-dessous de l'appareil.

Instructions importantes relatives à la sécurité

1. Veuillez lire ces consignes.
2. Veuillez conserver ces consignes.
3. Respectez tous les avertissements.
4. Suivez toutes les consignes.
5. N'utilisez pas cet appareil à proximité d'eau ou de toute autre source d'humidité.
6. Utilisez uniquement un chiffon sec pour le nettoyage.
7. Ne bloquez jamais les orifices d'aération. Suivez les instructions du fabricant pour l'installation.
8. N'installez pas cet appareil à proximité d'une quelconque source de chaleur, telle qu'un radiateur, une arrivée d'air chaud, un four ou tout autre appareil (notamment les amplificateurs) produisant de la chaleur.
9. Veillez à profiter de la sécurité offerte par les installations de type terre ou polarisées. Les fiches polarisées sont équipées de deux bornes de largeurs différentes. Les fiches de type terre sont équipées de deux bornes et d'un orifice pour la mise à la terre. Ces deux types de dispositifs ont pour but d'assurer votre sécurité. Si la prise fournie ne s'adapte pas à votre prise de courant, consultez un électricien pour qu'il remplace cette prise obsolète.
10. Protégez le cordon d'alimentation contre les risques de piétinement ou de pincement, notamment au niveau des fiches, des prises de courant et des branchements à l'appareil.
11. Utilisez uniquement les accessoires spécifiés par le fabricant.
12. Débranchez cet appareil pendant les orages ou au cours des longues périodes de non-utilisation.
13. Confiez toute réparation à du personnel qualifié. Une réparation est nécessaire lorsque l'appareil a été endommagé de quelque façon que ce soit (endommagement du cordon d'alimentation ou de la fiche électrique, renversement d'un liquide ou de tout objet sur l'appareil, exposition de l'appareil à la pluie ou à l'humidité, mauvais fonctionnement, chute de l'appareil, etc.).

AVERTISSEMENTS/PRÉCAUTIONS :

 Ce symbole sur le produit signale les instructions importantes mentionnées dans le guide d'installation, relatives au fonctionnement et à l'entretien de l'appareil.

 Ce symbole sur le produit indique la présence d'une tension électrique dangereuse non isolée à l'intérieur de l'appareil, susceptible d'induire un risque de décharge électrique.

 **AVERTISSEMENT :** Tous les produits Bose Professional doivent être installés dans le respect des réglementations locales et nationales. L'installateur est responsable du respect de tous les codes et règlements locaux et nationaux en vigueur applicables à l'installation et au montage des enceintes. Consultez les autorités locales compétentes avant d'installer ce produit.

 **AVERTISSEMENT :** Tout montage non sécurisé d'une lourde charge peut provoquer des dégâts matériels et des blessures graves, voire la mort. Il en va de la responsabilité de l'installateur d'évaluer la fiabilité de la méthode de montage utilisée, en fonction de l'application. Seul un installateur professionnel connaissant les accessoires et techniques de montage adaptés est qualifié pour installer des enceintes suspendues.

 **AVERTISSEMENT :** Pour limiter les risques d'incendie ou d'électrocution, n'exposez PAS cet appareil à la pluie, à toutes formes de liquides ou à l'humidité.

 **AVERTISSEMENT :** Ne montez pas le produit dans des endroits où de la condensation peut se former.

 **AVERTISSEMENT :** Ce produit n'est pas destiné à être monté ou utilisé dans des installations humides en intérieur (par exemple piscine intérieure, parc aquatique intérieur, baignoire à remous, sauna, hammam, patinoire intérieure, etc.).

 **AVERTISSEMENT :** Veillez à NE PAS effectuer de modifications non autorisées sur ce produit.

 **AVERTISSEMENT :** Veillez à NE PAS utiliser cet appareil dans des véhicules ou des bateaux.

 **AVERTISSEMENT :** Utilisez ce produit uniquement avec l'adaptateur secteur fourni.

 **AVERTISSEMENT :** Lorsque l'alimentation de secteur ou la prise multiple est utilisée comme dispositif de débranchement de l'appareil, le dispositif de débranchement doit rester facilement accessible.

 **AVERTISSEMENT :** Avant de brancher l'appareil à une prise de courant électrique, vérifiez que celle-ci soit bien raccordée à la terre ou qu'elle est dotée d'une protection par mise à la terre.

 **AVERTISSEMENT :** Les câbles d'enceintes et d'interconnexion fournis avec cet appareil ne sont pas compatibles avec une installation encastrée. Consultez la réglementation locale pour connaître le type de câblage requis pour une installation encastrée.

 **AVERTISSEMENT :** N'exposez PAS les produits contenant des piles ou des batteries à une chaleur excessive (ne les placez pas à la lumière directe du soleil, près d'un feu ou de toute autre source de chaleur).

 **AVERTISSEMENT :** La batterie fournie avec ce produit peut provoquer un incendie ou une brûlure chimique en cas de manipulation incorrecte.

 **ATTENTION :** Pour réduire les risques d'incendie, utiliser uniquement des conducteurs de télécommunications 26 AWG (0.41 mm Ø / 0.13 mm²) au de section supérieure.

 **AVERTISSEMENT :** Certaines petites pièces présentent un risque de suffocation. Ne les laissez pas à la portée des enfants de moins de 3 ans.

 **AVERTISSEMENT :** N'utilisez aucun type de solvant, d'huile de graissage ou de produit de nettoyage à base d'hydrocarbure sur ou autour des enceintes Bose Professional et du matériel de montage associé pendant l'installation. L'utilisation de ces solvants, huiles de graissage et produits de nettoyage à base d'hydrocarbure sur ou autour des fixations de montage et des vis peut entraîner une dégradation du matériel en plastique et occasionner de potentielles fissures ou une défaillance prématurée du produit.

 **PRÉCAUTION :** Tenez le produit à l'écart du feu et des sources de chaleur. Ne placez JAMAIS d'objets enflammés, tels que des bougies allumées, sur l'appareil ou à proximité.

 **PRÉCAUTION :** Utilisez exclusivement le matériel de montage en rack recommandé par le fabricant.

 **PRÉCAUTION :** Pour assurer une ventilation correcte, Bose Professional déconseille de placer ce produit dans un espace confiné tel qu'une cavité murale ou un placard fermé.

 **PRÉCAUTION :** N'installez pas le support ou le produit à proximité d'une source de chaleur, telle qu'une cheminée, un radiateur, une arrivée d'air chaud ou tout autre appareil (notamment les amplificateurs) produisant de la chaleur.

Informations réglementaires

CAN ICES-3 (A)/NMB-3(A)

Ce produit est conforme aux spécifications de la réglementation ICES-003 classe A du Canada. Cet appareil est conforme à la partie 15 de la réglementation de la FCC et au(x) standard(s) RSS exempté(s) de licence d'Industrie Canada. Son fonctionnement repose sur les deux conditions suivantes : (1) cet appareil ne doit pas provoquer d'interférences et (2) cet appareil doit tolérer les interférences externes, y compris celles qui peuvent provoquer un fonctionnement anormal.

REMARQUE : Ce matériel a fait l'objet de tests prouvant sa conformité aux limites imposées aux appareils numériques de classe A, conformément à la partie 15 des réglementations de la FCC. Ces limites sont conçues pour offrir une protection raisonnable contre les interférences nuisibles lorsque l'appareil est utilisé en environnement commercial. Cet appareil génère, utilise et est susceptible d'émettre de l'énergie à certaines fréquences radio. À ce titre, s'il n'est pas installé ou utilisé conformément aux instructions, il est susceptible de perturber les communications radio. L'utilisation de cet équipement dans une zone résidentielle risque de provoquer des interférences nuisibles, auquel cas l'utilisateur devra remédier au problème à ses propres frais.

Toute modification non autorisée expressément par Bose Professional est susceptible d'annuler le droit de l'utilisateur à utiliser cet appareil.

Ceci est un produit de catégorie A. Dans un environnement domestique, ce produit peut provoquer des interférences radio, auquel cas l'utilisateur devra prendre des mesures adéquates.

 Ce produit est conforme à toutes les directives de la Communauté Européenne qui s'y appliquent. L'attestation complète de conformité est disponible à l'adresse www.Bose.com/compliance.

 Ce produit est conforme à toutes les réglementations de 2016 en matière de compatibilité électromagnétique et à toutes les autres réglementations britanniques applicables. L'attestation complète de conformité est disponible à l'adresse www.Bose.com/compliance.

 Ce symbole signifie que le produit ne doit pas être jeté avec les déchets ménagers, mais doit être déposé dans un centre de collecte approprié pour recyclage. La mise au rebut adéquate et le recyclage permettent de protéger les ressources naturelles, la santé humaine et l'environnement. Pour plus d'informations sur l'élimination et le recyclage de ce produit, contactez votre mairie, votre service d'enlèvement des ordures ou le magasin où vous avez acheté ce produit.

Ce produit répond aux critères d'immunité de la norme EN55103-2 pour les environnements électromagnétiques classés E2.

Des câbles blindés doivent être utilisés pour assurer le respect des réglementations.

Spécifications du produit :

Tension d'entrée :	100 VAC – 240 VAC
Fréquence :	50/60 Hz
Courant ou puissance :	60 W maximum
Appel de courant au démarrage :	20 A à 120 V ; 38 A à 230 V

Date de fabrication : Le huitième chiffre du numéro de série indique l'année de fabrication ; par exemple, « 3 » correspond à 2013 ou à 2023.

Importateur pour la Chine : Bose Electronics (Shanghai) Company Limited, Level 6, Tower D, No. 2337 Gudai Rd. Minhang District, Shanghai 201100

Importateur pour le Royaume-Uni : Bose Limited, Bose House, Quayside Chatham Maritime, Chatham, Kent, ME4 4QZ, Royaume-Uni

Importateur pour l'UE : Bose Products B.V., Gorslaan 60, 1441 RG Purmerend, Pays-Bas

Importateur pour le Mexique : Bose de México, S. de R.L. de C.V., Paseo de las Palmas 405-204, Lomas de Chapultepec, 11000 México, D.F. Pour plus d'informations sur l'importateur et le service : +5255 (5202) 3545

Importateur pour Taïwan : Bose Taiwan Branch, 9F-A1, No. 10, Section 3, Minsheng East Road, Taipei City 104, Taiwan. Numéro de téléphone : +886-2-2514 7676

Bose Corporation, Framingham, MA 01701, U.S.A. 1-877-230-5639

Bose est une marque déposée de Bose Corporation. ControlSpace est une marque déposée de Transom Post OpCo LLC. AMX est une marque commerciale de AMX Corporation. Arm est une marque déposée de Arm Limited (ou de ses filiales) aux États-Unis et/ou dans d'autres pays. Crestron® est une marque déposée de Crestron Electronics, Inc. Dante™ est une marque commerciale d'Audinate Pty Ltd. Toutes les autres marques commerciales appartiennent à leurs propriétaires respectifs.

©2023 Transom Post OpCo LLC. Toute reproduction, modification, distribution ou autre utilisation, même partielle, de ce document est interdite sans autorisation écrite préalable.

Informations relatives à la garantie

Cet appareil est couvert par une garantie limitée.

Pour en savoir plus sur la garantie, consultez la page BoseProfessional.com/Warranty.

Bitte lesen Sie alle Sicherheitshinweise und Gebrauchsanleitungen durch und bewahren Sie sie auf.

Dieses Produkt darf nur von fachkundigen Monteuren installiert werden! Dieses Dokument soll fachkundigen Monteuren grundlegende Installations- und Sicherheitsrichtlinien für dieses Produkt in typischen Festinstallationsystemen bieten. Bitte lesen Sie dieses Dokument und alle Sicherheitshinweise vor der Installation durch.

Versuchen Sie nicht, dieses Produkt selbst zu warten. Lassen Sie jegliche Reparatur- und Wartungsarbeiten nur von autorisierten Servicepartnern, Monteuren, Technikern, Händlern oder Vertreibern durchführen. Die Bose Professional Kontaktdaten für Ihr Land sowie Informationen zu Händlern oder Vertreibern in Ihrer Nähe finden Sie auf BoseProfessional.com.

Das Etikett mit der Produktbezeichnung befindet sich auf der Unterseite des Geräts.

Wichtige Sicherheitshinweise

1. Lesen Sie die folgenden Anweisungen.
2. Bewahren Sie die Anweisungen auf.
3. Beachten Sie alle Warn- und Sicherheitshinweise.
4. Befolgen Sie alle Anweisungen.
5. Verwenden Sie dieses Gerät nicht in der Nähe von Wasser.
6. Reinigen Sie das Gerät nur mit einem sauberen, trockenen Tuch.
7. Achten Sie darauf, dass die Lüftungsöffnungen nicht blockiert sind. Stellen Sie das Gerät nur in Übereinstimmung mit den Herstelleranweisungen auf.
8. Stellen Sie das Gerät nicht in der Nähe von Wärmequellen auf, wie zum Beispiel Heizkörpern, Wärmespeichern, Öfen oder anderen Geräten (auch Verstärkern), die Wärme erzeugen.
9. Achten Sie darauf, dass die Schutzfunktion des Schutzkontaktsteckers nicht beeinträchtigt wird. Ein gepolter Stecker hat zwei Stromkontakte, von denen einer breiter als der andere ist. Ein Schutzkontaktstecker hat zwei Stromkontakte und einen dritten Erdungskontakt. Der breitere bzw. dritte Kontakt dient Ihrer Sicherheit. Falls der mitgelieferte Stecker nicht in Ihre Steckdose passt, wenden Sie sich an einen qualifizierten Elektriker, um die Steckdose auszutauschen.
10. Verlegen Sie das Netzkabel so, dass es keine Stolpergefahr darstellt und nicht beschädigt werden kann – insbesondere im Bereich von Steckern und Steckdosen und dort, wo das Netzkabel aus dem Gerät herausgeführt wird.
11. Verwenden Sie nur Zubehör-/Anbauteile, die vom Hersteller zugelassen sind.
12. Ziehen Sie das Netzkabel bei Gewitter oder bei längerer Nichtbenutzung des Gerätes aus der Steckdose.
13. Lassen Sie jegliche Reparatur- und Wartungsarbeiten nur von qualifiziertem Fachpersonal durchführen. Wartungsarbeiten sind in folgenden Fällen nötig: bei jeglichen Beschädigungen wie z. B. des Netzkabels oder Netzsteckers, wenn Flüssigkeiten oder Gegenstände in das Gehäuse gelangt sind, das Gerät Regen oder Feuchtigkeit ausgesetzt wurde, fallen gelassen wurde oder nicht ordnungsgemäß funktioniert.

WARNHINWEISE:



Dieser Warnhinweis auf dem Produkt weist auf wichtige Bedien- und Wartungsinformationen in dieser Anleitung hin.



Dieser Warnhinweis auf dem Produkt warnt vor nicht isolierten gefährlichen Spannungsquellen im Inneren des Produktes, die ein Stromschlagrisiko darstellen können. Es besteht die Gefahr von Stromschlägen!



WARNUNG: Alle Produkte von Bose Professional müssen gemäß den örtlichen und staatlichen Vorschriften sowie gemäß allen Branchenbestimmungen installiert werden. Der Monteur ist dafür verantwortlich, sicherzustellen, dass die Installation der Lautsprecher und der Halterung gemäß allen geltenden Vorschriften durchgeführt wird, einschließlich örtlicher Bauvorschriften und -bestimmungen. Wenden Sie sich vor der Installation dieses Produkts an die zuständige abnehmende Behörde.



WARNUNG: Eine unsichere Befestigung schwerer Lasten oder deren Aufhängung über Kopf kann zu schweren oder tödlichen Verletzungen und Sachschäden führen. Der Monteur ist dafür verantwortlich, die Zuverlässigkeit der für die Anwendung verwendeten Befestigungstechniken zu prüfen. Nur fachkundige Monteure mit Wissen über sachgemäße Befestigungselemente und sichere Befestigungstechniken sollten Lautsprecher über Kopf installieren.



WARNUNG: Um Brände und Stromschläge zu vermeiden, darf dieses Produkt NICHT Regen, Flüssigkeiten oder Feuchtigkeit ausgesetzt werden.



WARNUNG: Montieren Sie das Produkt nicht an Orten, an denen Kondenswasser auftreten kann.



WARNUNG: Dieses Produkt ist nicht für die Installation oder Verwendung in Bereichen mit Wassereinrichtungen in Innenräumen (zum Beispiel Schwimmbädern, Wasserparks, Räume mit Whirlpools, Saunas, Dampfbädern und Eislaufbahnen) gedacht.



WARNUNG: Nehmen Sie KEINE nicht genehmigten Änderungen an diesem Produkt vor.



WARNUNG: Verwenden Sie das Produkt NICHT in Fahrzeugen oder Booten.



WARNUNG: Verwenden Sie dieses Produkt nur mit dem mitgelieferten Netzteil.



WARNUNG: Falls Sie den Netzstecker oder eine Mehrfachsteckdose verwenden, um das Gerät von der Stromversorgung zu trennen, sollten Sie sicherstellen, dass Sie jederzeit auf den Stecker zugreifen können.



WARNUNG: Nutzen Sie einen Erdungsanschluss oder stellen Sie sicher, dass an der Steckdose ein Erdungsschutz vorliegt, bevor Sie den Netzstecker an die Steckdose anschließen.



WARNUNG: Die mit diesem System mitgelieferten Lautsprecher- und Verbindungskabel sind nicht für den Wandeinbau zugelassen. Bitte sehen Sie in Ihren örtlichen Bauvorschriften nach, welcher Kabeltyp für den entsprechenden Wandeinbau erforderlich ist.



WARNUNG: Setzen Sie Geräte, die Batterien enthalten, NICHT übermäßig hohen Temperaturen aus (in dem Sie sie z. B. direkter Sonneneinstrahlung aussetzen oder in der Nähe von Feuer usw. lagern).



WARNUNG: Der Akku, der mit diesem Produkt geliefert wurde, kann möglicherweise ein Brand- oder Verätzungsrisiko darstellen, wenn er nicht sachgemäß gehandhabt wird.



WARNUNG: Enthält kleine Teile, die verschluckt werden können und eine Erstickungsgefahr darstellen. Nicht geeignet für Kinder unter drei Jahren.



WARNUNG: Verwenden Sie keine auf Kohlenwasserstoff basierenden Lösungsmittel, Schmiermittel oder Reinigungsmittel am oder in der Nähe des Bose Professional Lautsprechers oder während der Installation mit dem zugehörigen Montagematerial. Diese Mittel können den Kunststoff des Lautsprechers und der Montagevorrichtungen angreifen und zu Rissen im Material und somit zu einem (vorzeitigen) Produktdefekt führen.



VORSICHT: Halten Sie das Produkt von Feuer und Wärmequellen fern. Stellen Sie KEINE brennenden Kerzen oder ähnliches auf das Gerät oder in die Nähe des Geräts.



VORSICHT: Verwenden Sie nur die vom Rack-Hersteller empfohlenen Montagehilfsmittel.



VORSICHT: Aufgrund der Belüftungsanforderungen sollten Sie das Produkt nicht in einem geschlossenen Raum, zum Beispiel in einer Wandnische oder in einem geschlossenen Schrank, aufstellen.



VORSICHT: Montieren oder platzieren Sie das Gerät nicht in der Nähe von Wärmequellen wie Heizkörpern, Wärmespeichern oder anderen Geräten.

Gesetzliche Hinweise

CAN ICES-3(A)/NMB-3(A)

Dieses Produkt erfüllt die kanadische Richtlinie ICES-003, Klasse A.

Dieses Gerät erfüllt die Bestimmungen in Teil 15 der FCC-Vorschriften und die lizenzfreien Standards von Industry Canada. Der Betrieb unterliegt den beiden folgenden Bedingungen: (1) dieses Gerät darf keine Störungen verursachen und (2) dieses Gerät muss jegliche Störungen tolerieren, einschließlich Störungen, die zu unerwünschten Betriebsstörungen führen.

Hinweis: Dieses Gerät wurde geprüft. Es stimmt mit den Regelungen für Geräte der Klasse A gemäß Teil 15 der FCC-Vorschriften überein. Diese Grenzwerte sollen einen angemessenen Schutz gegen elektromagnetische Störungen beim Betrieb in gewerblicher Umgebung gewährleisten. Dieses Gerät erzeugt und verwendet Hochfrequenzstrahlung und kann sie auch aussenden. Daher verursacht das Gerät, wenn die Installation und Benutzung nicht in Übereinstimmung mit dieser Bedienungsanleitung erfolgt, möglicherweise Störungen des Funkverkehrs. Beim Betrieb dieses Geräts in Wohngebieten können erhebliche Störungen des Funkverkehrs verursacht werden. Eventuell daraus entstehende Kosten trägt allein der Benutzer des Geräts.

Veränderungen am Gerät, die nicht durch die Bose Professional autorisiert wurden, können zur Folge haben, dass die Betriebserlaubnis für das Gerät erlischt.

Dies ist ein Produkt der Klasse A. Das Produkt kann im Wohnbereich Funkstörungen verursachen. In diesem Fall kann es für den Betreiber erforderlich sein, entsprechende Maßnahmen zu ergreifen.

Dieses Produkt erfüllt alle vorgeschriebenen EU-Richtlinien. Die vollständige Konformitätserklärung ist einsehbar unter www.Bose.com/compliance.



Dieses Produkt erfüllt alle geltenden Vorschriften zur elektromagnetischen Verträglichkeit 2016 und alle anderen zutreffenden UK-Richtlinien. Die vollständige Konformitätserklärung ist einsehbar unter www.Bose.com/compliance.



Dieses Symbol bedeutet, dass das Produkt nicht mit dem Hausmüll entsorgt werden darf, sondern bei einer geeigneten Sammelstelle für das Recycling abgegeben werden muss. Die ordnungsgemäße Entsorgung und das Recycling tragen dazu bei, die natürlichen Ressourcen, die Gesundheit und die Umwelt zu schützen. Weitere Informationen zur Entsorgung und zum Recycling dieses Produkts erhalten Sie von Ihrer zuständigen Kommune, Ihrem Entsorgungsdienst oder dem Geschäft, in dem Sie dieses Produkt gekauft haben.

Dieses Produkt erfüllt alle Anforderungen nach EN55103-2 für elektromagnetische Verträglichkeit.

Abgeschirmte Kabel müssen den gesetzlichen Vorschriften entsprechen.

Leistungsdaten:	Eingangsspannung:	100 VAC – 240 VAC
	Frequenz:	50/60 Hz
	Nennleistung:	Max. 60 W
	Einschaltstrom bei erstem Einschalten:	20 A bei 120 V; 38 A bei 230 V

Herstellungsdatum: Die achte Ziffer in der Seriennummer gibt das Herstellungsjahr an: „3“ ist 2013 oder 2023.

Importeur aus China: Bose Electronics (Shanghai) Company Limited, Level 6, Tower D, No. 2337 Gudai Rd. Minhang District, Shanghai 201100

Importeur aus UK: Bose Limited, Bose House, Quayside Chatham Maritime, Chatham, Kent, ME4 4QZ, Vereinigtes Königreich

Importeur aus der EU: Bose Products B.V., Gorslaan 60, 1441 RG Purmerend, Niederlande

Importeur aus Mexiko: Bose de México, S. de R.L. de C.V., Paseo de las Palmas 405-204, Lomas de Chapultepec, 11000 México, D.F. Importeur- und Serviceinformationen erhalten Sie unter: +5255 (5202) 3545

Importeur aus Taiwan: Bose Taiwan Branch, 9F-A1, No. 10, Section 3, Minsheng East Road, Taipei City 104, Taiwan. Tel.: +886-2-2514 7676

Bose Corporation, Framingham, MA 01701, U.S.A. 1-877-230-5639

Bose ist eine Marke von Bose Corporation. ControlSpace ist eine Marke von Transom Post OpCo LLC. AMX ist eine Marke von AMX Corporation. Arm ist eine eingetragene Marke von Arm Limited (oder seinen Tochterunternehmen) in den USA und/oder anderen Ländern. Crestron® ist eine eingetragene Marke von Crestron Electronics, Inc. Dante™ ist eine Marke von Audinate Pty Ltd. Alle anderen Marken sind das Eigentum ihrer jeweiligen Inhaber.

©2023 Transom Post OpCo LLC. Dieses Dokument darf ohne vorherige schriftliche Genehmigung weder ganz noch teilweise reproduziert, verändert, vertrieben oder in anderer Weise verwendet werden.

Garantiehinweise

Für dieses Produkt gilt eine eingeschränkte Garantie. Einzelheiten zur Garantie finden Sie unter BoseProfessional.com/Warranty.

Leggere e conservare tutte le istruzioni per la sicurezza e per l'uso.

Questo prodotto deve essere installato esclusivamente da installatori professionisti. Il presente documento ha lo scopo di fornire agli installatori professionisti le istruzioni di base per l'installazione e la sicurezza del prodotto in tipici impianti da installazione fissa. Prima dell'installazione, leggere questo documento e le avvertenze sulla sicurezza.

Non tentare di riparare il prodotto autonomamente. Per tutti gli interventi di assistenza, rivolgeti ai centri assistenza, agli installatori, ai tecnici, ai rivenditori o ai distributori autorizzati. Per contattare Bose Professional o per trovare il rivenditore o distributore più vicino, visita BoseProfessional.com.

L'etichetta identificativa è situata sul fondo del prodotto.

Informazioni importanti sulla sicurezza

1. Leggere queste istruzioni.
2. Conservare queste istruzioni.
3. Prestare attenzione a tutte le avvertenze.
4. Seguire tutte le istruzioni.
5. Non utilizzare l'apparecchio in prossimità di acqua.
6. Per la pulizia utilizzare un semplice panno asciutto.
7. Non ostruire le aperture di ventilazione. Installare il prodotto in conformità con le istruzioni fornite dal produttore.
8. Non installare in prossimità di fonti di calore, quali termosifoni, radiatori, stufe o altri apparecchi (compresi gli amplificatori) che generino calore.
9. Non danneggiare le parti di sicurezza della spina polarizzata o con messa a terra. Una spina polarizzata è dotata di due poli, uno più largo dell'altro. Una spina con messa a terra è dotata di due poli e di un terzo terminale di massa. Il polo più largo e il terzo terminale sono presenti per sicurezza. Se la spina in dotazione non è adatta alla presa, rivolgersi a un elettricista per la sostituzione della presa obsoleta.
10. Evitare che il cavo di alimentazione venga calpestato o schiacciato, soprattutto in corrispondenza di spine, prese e nel punto di uscita dell'apparecchio.
11. Utilizzare solo sistemi di fissaggio/accessori specificati dal produttore.
12. Scollegare l'apparecchio durante i temporali o quando non utilizzato per lunghi periodi di tempo.
13. Affidarsi a personale qualificato per tutti gli interventi di assistenza. Gli interventi di assistenza si rendono necessari in caso di danni di qualsiasi tipo all'apparecchio; ad esempio se il cavo di alimentazione o la spina sono danneggiati, se è stato versato liquido o sono caduti oggetti sull'apparecchio, se l'apparecchio è stato esposto a pioggia o umidità, se non funziona normalmente o è caduto.

AVVISI/AVVERTENZE:

 Questo simbolo sul prodotto segnala istruzioni importanti di funzionamento e di manutenzione presenti in questa guida.

 Questo simbolo sul prodotto indica la presenza di tensioni pericolose non isolate all'interno del telaio del prodotto e del conseguente rischio di scosse elettriche.

 **AVVERTIMENTO:** Tutti i prodotti Bose Professional devono essere installati in conformità con gli standard locali, statali, federali e di settore. È responsabilità dell'installatore assicurare che l'installazione dei diffusori e del sistema di montaggio venga eseguita in conformità con le normative vigenti, compresi i regolamenti edilizi locali. Prima di installare il prodotto, chiedere informazioni all'autorità locale preposta.

 **AVVERTIMENTO:** L'installazione non sicura o la sospensione di carichi pesanti può causare gravi lesioni alle persone e danni alle cose. È responsabilità dell'installatore valutare l'affidabilità del metodo di installazione utilizzato per l'applicazione specifica. L'installazione di un diffusore in posizione elevata può essere affidata solo ad installatori professionisti esperti di tecniche di montaggio sicuro dell'hardware.

 **AVVERTIMENTO:** Per ridurre il rischio di incendio o scosse elettriche, questo prodotto NON deve essere esposto a pioggia, liquidi o umidità.

 **AVVERTIMENTO:** Non posizionare il prodotto in punti dove potrebbe formarsi condensa.

 **AVVERTIMENTO:** Questo prodotto non deve essere installato o utilizzato in aree di servizio o intrattenimento vicine all'acqua (ad esempio, piscine coperte, parchi acquatici al chiuso, sale con vasche riscaldate, saune, bagni turchi e piste di pattinaggio al chiuso).

 **AVVERTIMENTO:** NON apportare alterazioni non autorizzate al prodotto.

 **AVVERTIMENTO:** NON utilizzare all'interno di veicoli o imbarcazioni.

 **AVVERTIMENTO:** Utilizzare questo prodotto esclusivamente con l'alimentatore fornito in dotazione.

 **AVVERTIMENTO:** La spina dell'alimentazione o dell'accoppiatore deve essere raggiungibile facilmente e rapidamente se utilizzata come dispositivo di spegnimento.

 **AVVERTIMENTO:** Dotare la presa di messa a terra oppure accertarsi che la stessa sia dotata di messa a terra di protezione prima di collegare la spina di alimentazione.

 **AVVERTIMENTO:** I cavi per diffusori e di interconnessione forniti in dotazione con questo sistema non sono approvati per l'installazione all'interno di muri. Consultare le norme locali per l'edilizia per individuare i tipi di cavi richiesti per l'installazione all'interno di muri.

 **AVVERTIMENTO:** NON esporre prodotti contenenti batterie a calore eccessivo (ad esempio luce diretta del sole, fuoco o simili).

 **AVVERTIMENTO:** La batteria in dotazione al prodotto può determinare il rischio di incendi o ustioni chimiche se non utilizzata correttamente.

 **AVVERTIMENTO:** Contiene pezzi di piccole dimensioni che possono rappresentare un pericolo di soffocamento. Non adatto per bambini di età inferiore a 3 anni.

 **AVVERTIMENTO:** Non utilizzare solventi a base di idrocarburi, lubrificanti o detersivi di qualunque tipo su o intorno ai diffusori Bose Professional e sui relativi hardware di montaggio durante l'installazione. L'impiego di detersivi, lubrificanti e solventi a base di idrocarburi su o intorno a viti ed elementi di ancoraggio può danneggiare i materiali plastici e provocare spaccature e danni prematuri del prodotto.

 **ATTENZIONE:** Tenere il prodotto lontano dal fuoco e da fonti di calore. NON collocare sorgenti di fiamme libere (ad esempio, candele accese) sul prodotto o in prossimità di esso.

 **ATTENZIONE:** Utilizzare esclusivamente l'hardware di montaggio raccomandato dal produttore dell'unità rack.

 **ATTENZIONE:** A causa dei requisiti di ventilazione, Bose Professional sconsiglia di posizionare il prodotto in spazi chiusi o angusti, ad esempio nicchie a parete o armadietti.

 **ATTENZIONE:** NON posizionare o installare la staffa o il prodotto in prossimità di fonti di calore, quali caminetti, termosifoni, radiatori o altri apparati (inclusi amplificatori) che emettano calore.

Informazioni sulle normative

CAN ICES-3(A)/NMB-3(A)

Questo prodotto è conforme alle specifiche canadesi ICES-003 di Classe A.

Questo dispositivo è conforme alla parte 15 delle Norme FCC e agli standard Industry Canada RSS esenti da licenza. Il funzionamento è soggetto alle due seguenti condizioni: (1) il dispositivo non può causare interferenze dannose e (2) deve accettare le interferenze ricevute, incluse quelle che potrebbero causare un funzionamento indesiderato del dispositivo.

Nota: Questa apparecchiatura è stata sottoposta a collaudo ed è risultata conforme ai limiti relativi ai dispositivi digitali di Classe A previsti dalla Parte 15 delle norme FCC. Tali limiti sono stati fissati allo scopo di assicurare un'adeguata protezione da interferenze nocive quando l'apparecchiatura è utilizzata in un'installazione commerciale. Questa apparecchiatura genera, utilizza e può irradiare energia a radiofrequenza e, se non installata e utilizzata in conformità con il manuale di istruzioni, può causare interferenze con le locali comunicazioni radiofoniche. L'utilizzo di questa apparecchiatura in un'area residenziale può provocare interferenze nocive, nel qual caso l'utente dovrà adottare misure correttive a proprie spese.

Eventuali modifiche o alterazioni non espressamente approvate da Bose Professional possono rendere nulla l'autorizzazione dell'utente all'utilizzo dell'apparecchiatura stessa.

Prodotto di Classe A. In ambienti domestici, il prodotto può causare interferenze radio che potrebbero richiedere misure adeguate da parte dell'utente.

 Questo prodotto è conforme a tutte le direttive EU prescritte dalla legge. La dichiarazione di conformità completa è disponibile all'indirizzo www.Bose.com/compliance.

 Il presente prodotto è conforme a tutte le normative sulla compatibilità elettromagnetica del 2016 e a tutte le altre normative del Regno Unito applicabili. La dichiarazione di conformità completa è disponibile all'indirizzo: www.Bose.com/compliance.

 Questo simbolo indica che il prodotto non deve essere smaltito con i rifiuti domestici, ma deve essere consegnato a una struttura di raccolta appropriata per il riciclaggio. Uno smaltimento e un riciclo corretti aiutano a preservare le risorse naturali, la salute e l'ambiente. Per ulteriori informazioni sullo smaltimento e sul riciclo di questo prodotto, rivolgersi alle autorità locali, al servizio di smaltimento dei rifiuti o al negozio presso il quale è stato acquistato.

Il prodotto è conforme a tutti i requisiti di immunità EN55103-2 per ambienti elettromagnetici di tipo E2. La conformità alle normative richiede l'utilizzo di cavi schermati.

Specifiche di prodotto:	Tensione d'ingresso:	100 V CA - 240 V CA
	Frequenza:	50/60 Hz
	Valore di corrente o potenza:	massimo 60 W
	Corrente di spunto all'accensione iniziale:	20 A @ 120 V; 38 A @ 230 V

Data di produzione: l'ottava cifra del numero di serie corrisponde all'anno di produzione; ad esempio "3" indica 2013 o 2023.

Importatore per la Cina: Bose Electronics (Shanghai) Company Limited, Level 6, Tower D, No. 2337 Gudai Rd. Minhang District, Shanghai 201100

Importatore per l'UE: Bose Products B.V., Gorslaan 60, 1441 RG Purmerend, Paesi Bassi

Importatore per il Messico: Bose de México, S. de R.L. de C.V., Paseo de las Palmas 405-204, Lomas de Chapultepec, 11000 México, D.F. Per informazioni su importatori e servizi: +5255 (5202) 3545

Importatore per Taiwan: Bose Taiwan Branch, 9F-A1, No.10, Section 3, Minsheng East Road, Taipei City 104, Taiwan. N. telefono: +886-2-2514 7676

Bose Corporation, Framingham, MA 01701, U.S.A. 1-877-230-5639

Bose è un marchio commerciale di Bose Corporation. ControlSpace è un marchio commerciale di Transom Post OpCo LLC. AMX è un marchio di AMX Corporation. Arm è un marchio registrato di Arm Limited (o delle sue consociate) negli Stati Uniti e/o in altri Paesi. Crestron® è un marchio registrato di Crestron Electronics, Inc. Dante™ è un marchio di Audinate Pty Ltd. Tutti gli altri marchi sono di proprietà dei rispettivi titolari.

©2023 Transom Post OpCo LLC. Nessuna parte di questo documento può essere riprodotta, modificata, distribuita o usata in altro modo senza previa autorizzazione scritta..

Informazioni sulla garanzia

Questo prodotto è coperto da una garanzia limitata. Per i dettagli sulla garanzia, visitare BoseProfessional.com/Warranty.

Lees alle veiligheidsinstructies en de gebruiksaanwijzing door en bewaar deze.

Dit product is uitsluitend bestemd voor installatie door professionele installateurs! Dit document is bedoeld om professionele installateurs essentiële installatie- en veiligheidsrichtlijnen te bieden voor dit product in standaardssystemen voor vaste installatie. Lees dit document en alle veiligheids waarschuwingen voordat u een systeem probeert te installeren.

Probeer dit product niet zelf te repareren. Neem voor alle onderhoud contact op met een geautoriseerd servicecenter, installateur, technicus, dealer of distributeur. Om contact op te nemen met Bose Professional en voor informatie over de dichtstbijzijnde dealer of distributeur, gaat u naar BoseProfessional.com.

Het productlabel bevindt zich aan de onderkant van het product.

Belangrijke veiligheidsinstructies

1. Lees deze instructies door.
2. Bewaar deze instructies.
3. Neem alle waarschuwingen in acht.
4. Volg alle instructies.
5. Gebruik dit apparaat niet in de buurt van water.
6. Alleen met een droge doek reinigen.
7. Zorg dat u de ventilatieopeningen niet blokkeert. Installeer het apparaat volgens de instructies van de fabrikant.
8. Installeer het product niet in de buurt van warmtebronnen, zoals radiatoren, warmteroosters, kachels of andere apparaten (waaronder versterkers) die warmte produceren.
9. Schakel de veiligheidsfunctie van de gepolariseerde of geaarde stekker niet uit. Een gepolariseerde stekker heeft twee poten, waarvan de ene breder is dan de andere. Een geaarde stekker heeft twee poten en een pin voor de aarding. De bredere poot of de derde poot is bedoeld voor uw veiligheid. Als de bijgeleverde stekker niet in het stopcontact past, neem dan contact op met een electricien om het verouderde stopcontact te vervangen.
10. Zorg dat er niet op het netsnoer wordt gestaan of gelopen en dat het niet wordt afgekend, met name bij de stekkers en stopcontacten en het punt waar deze uit het apparaat komen.
11. Gebruik uitsluitend aansluitstukken/accessoires die door de fabrikant worden gespecificeerd.
12. Haal de stekker van dit apparaat uit het stopcontact bij onweer of als het langere tijd niet wordt gebruikt.
13. Laat alle reparaties en onderhoud over aan bevoegde personen. Reparatie is vereist als het apparaat is beschadigd, zoals wanneer het snoer of de stekker van de voeding is beschadigd, wanneer er vloeistof in het apparaat is terechtgekomen of voorwerpen in het apparaat zijn gevallen, wanneer het apparaat is blootgesteld aan regen of vocht, niet normaal werkt of is gevallen.

WAARSCHUWINGEN:



Dit symbool op het product betekent dat deze handleiding belangrijke bedienings- en onderhoudsinstructies bevat.



Dit symbool op het product betekent dat er een niet-geïsoleerde, gevaarlijke spanning aanwezig is binnen de behuizing van het product die kan leiden tot een risico op elektrische schokken.



WAARSCHUWING: Alle Bose Professional-producten moeten worden geïnstalleerd volgens de plaatselijke en landelijke voorschriften en industriënormen. Het is de verantwoordelijkheid van de installateur om ervoor te zorgen dat de installatie van de luidsprekers en het montagesysteem gebeurt met inachtneming van alle van toepassing zijnde voorschriften, waaronder plaatselijke bouwvoorschriften. Neem contact op met de juiste plaatselijke overheidsinstanties voordat u dit product installeert.



WAARSCHUWING: Het onveilig monteren of ophangen van een zware last kan leiden tot beschadiging van uw eigendommen, ernstig letsel en overlijden. Het is de verantwoordelijkheid van de installateur om de betrouwbaarheid te evalueren van de gebruikte montagemethode. Alleen professionele installateurs met kennis van het juiste gereedschap en veilige montage technieken mogen luidsprekers hoog ophangen.



WAARSCHUWING: Om het risico op brand of elektrische schokken te verlagen, mag dit product NIET worden blootgesteld aan regen, vloeistof of vocht.



WAARSCHUWING: Monteer het product niet op locaties waar condensatie kan optreden.



WAARSCHUWING: Dit product is niet bedoeld voor installatie of gebruik in overdekte ruimten voor wateractiviteiten (waaronder overdekte zwembaden, overdekte waterparken, stoomruimten, sauna's, bubbelbadkamers en overdekte ijsbanen).



WAARSCHUWING: Er mogen GEEN wijzigingen aan dit product worden aangebracht door onbevoegden.



WAARSCHUWING: Gebruik het NIET in voertuigen of boten.



WAARSCHUWING: Dit product mag alleen worden gebruikt met de bijgeleverde voeding.



WAARSCHUWING: Wanneer de stekker of aansluiting van een apparaat als stroomonderbreker wordt gebruikt, dient deze stroomonderbreker steeds goed bereikbaar te zijn.



WAARSCHUWING: Zorg voor aarding of controleer of het stopcontact geaard is voordat u de stekker in het stopcontact steekt.



WAARSCHUWING: De bij dit systeem geleverde luidsprekerdraad en kabels zijn niet geschikt voor montage in de muur. Raadpleeg de plaatselijke bouwvoorschriften voor het juiste type bedrading en kabels voor installatie in een muur.



WAARSCHUWING: Producten die accu's of batterijen bevatten NIET blootstellen aan overmatige warmte (zoals direct zonlicht, vuur en dergelijke).



WAARSCHUWING: Onjuiste behandeling van de accu in dit product kan leiden tot een risico op brand of chemische brandwonden.



WAARSCHUWING: Bevat kleine onderdelen die verstikkingsgevaar kunnen vormen. Niet geschikt voor kinderen jonger dan 3 jaar.



WAARSCHUWING: Gebruik bij de installatie geen oplosmiddelen, smeermiddelen of reinigingsmiddelen op koolwaterstofbasis op of rond Bose Professional-luidsprekers en bijbehorende montage materialen. Het gebruik van dergelijke smeermiddelen, oplosmiddelen of reinigingsmiddelen op koolwaterstofbasis op of rond de bevestigingsankers en schroeven kan nadelige gevolgen hebben voor het kunststof materiaal en mogelijk scheuren en vroegtijdige verzwakking van het product veroorzaken.



VOORZICHTIGHEID: Houd het product uit de buurt van vuur en warmtebronnen. Plaats GEEN open vlammen, zoals brandende kaarsen, op of bij het product.



VOORZICHTIGHEID: Gebruik uitsluitend het door de fabrikant aanbevolen montage materiaal.



VOORZICHTIGHEID: Omwille van de ventilatievereisten raadt Bose Professional af om het product in een besloten ruimte te plaatsen, zoals in een nis in de muur of een dichte kast.



VOORZICHTIGHEID: Plaats of installeer de beugel of het product niet in de buurt van warmtebronnen, zoals open haarden, radiatoren, verwarmingsroosters of andere apparaten (waaronder versterkers) die warmte produceren.

Wettelijk verplichte informatie

CAN ICES-3(A)/NMB-3(A)

Dit product voldoet aan de specificaties van de Canadese ICES-003 klasse A.

Dit apparaat voldoet aan deel 15 van de FCC-voorschriften en de RSS-norm(en) van Industry Canada voor vergunningsvrije apparaten. Op het gebruik zijn de volgende twee voorwaarden van toepassing: (1) Dit apparaat mag geen schadelijke storing veroorzaken, en (2) dit apparaat moet bestand zijn tegen alle externe storing, waaronder storing die een ongewenste werking tot gevolg kan hebben.

Opmerking: Dit apparaat is getest en voldoet aan de limieten voor een digitaal apparaat van de klasse A, volgens deel 15 van de FCC-voorschriften. Deze limieten zijn bedoeld om redelijke bescherming te bieden tegen schadelijke storing bij installatie in een handelsomgeving. Dit apparaat genereert en gebruikt radiofrequente energie en kan deze uitzenden en het kan, als het niet wordt geïnstalleerd en gebruikt volgens de instructies, schadelijke storing veroorzaken aan radiocommunicatie. Gebruik van dit apparaat in een woonwijk kan schadelijke storing veroorzaken. In dit geval moet de gebruiker de storing op eigen kosten verhelpen.

Veranderingen of aanpassingen die niet uitdrukkelijk zijn goedgekeurd door Bose Professional kunnen leiden tot het vervallen van de bevoegdheid van de gebruiker om dit apparaat te gebruiken.

Dit is een product van klasse A. Dit product kan in een woonomgeving radio-interferentie veroorzaken, zodat de gebruiker mogelijk passende maatregelen moet treffen.

Dit product voldoet aan alle vereisten van de EU-richtlijnen, zoals wettelijk vereist. De volledige conformiteitsverklaring kunt u vinden op www.Bose.com/compliance.



Dit product voldoet aan alle toepasselijke voorschriften in de Electromagnetic Compatibility Regulations 2016 en aan alle overige toepasselijke wet- en regelgeving van het Verenigd Koninkrijk. De volledige conformiteitsverklaring kunt u vinden op: www.Bose.com/compliance.



Dit symbool betekent dat het product niet mag worden weggegooid als huishoudelijk afval en naar een geschikt inzamelpunt voor recycling moet worden gebracht. Het op de juiste wijze afvoeren en recycleren helpt natuurlijke hulpbronnen, de menselijke gezondheid en het milieu te beschermen. Voor meer informatie over het afvoeren en recycleren van dit product neemt u contact op met de gemeente waar u woont, de afvalverwerkingsdienst of de winkel waar u dit product hebt gekocht.

Dit product voldoet aan alle immuniteitsvereisten van EN55103-2 voor een E2 elektromagnetische omgeving.

Afgeschermde kabels zijn vereist om aan de regelgeving te voldoen.

Productvermogen:	Ingangsspanning: 100 VAC – 240 VAC
	Frequentie: 50/60 Hz
	Stroomsterkte: Maximaal 60 W
	Initiële inschakelstroom: 20 A bij 120 V; 38 A bij 230 V

Fabricagedatum: Het achtste cijfer in het serienummer geeft het fabricagejaar aan. '3' is 2013 of 2023.

Importeur in China: Bose Electronics (Shanghai) Company Limited, Level 6, Tower D, No. 2337 Gudai Rd. Minhang District, Shanghai 201100

Importeur in het VK: Bose Limited, Bose House, Quayside Chatham Maritime, Chatham, Kent, ME4 4QZ, United Kingdom

Importeur in de EU: Bose Products B.V., Gorslaan 60, 1441 RG Purmerend, Nederland

Importeur in Mexico: Bose de México, S. de R.L. de C.V., Paseo de las Palmas 405-204, Lomas de Chapultepec, 11000 México, D.F. Gegevens importeur en service-informatie: +52 55 52 02 35 45

Importeur in Taiwan: Bose Taiwan Branch, 9F-A1, No.10, Section 3, Minsheng East Road, Taipei City 104, Taiwan. Telefoonnummer: +886 2 25 14 76 76

Bose Corporation, Framingham, MA 01701, U.S.A. 1-877-230-5639

Bose is een handelsmerk van Bose Corporation. ControlSpace is een handelsmerk van Transom Post OpCo LLC. AMX is een handelsmerk van AMX Corporation. Arm is een geregistreerd handelsmerk van Arm Limited (of diens gelieerde ondernemingen) in de VS en/of elders. Crestron® is een geregistreerd handelsmerk van Crestron Electronics, Inc. Dante™ is een handelsmerk van Audinate Pty Ltd. Alle overige handelsmerken zijn het eigendom van hun respectieve eigenaars.

©2023 Transom Post OpCo LLC. Niets in deze uitgave mag worden gereproduceerd, gewijzigd, gedistribueerd of op andere wijze worden gebruikt zonder voorafgaande schriftelijke toestemming.

Garantie-informatie

Dit product wordt gedekt door een beperkte garantie.

Ga naar BoseProfessional.com/Warranty voor garantie-informatie.

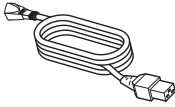
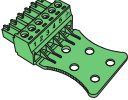
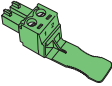
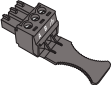
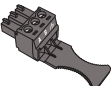
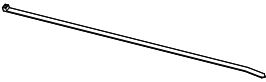

Table of Contents

Overview.....	9	Operation	20
Package Contents	9	Display Menus & Pages	20
Available Accessories	10	Main Menu.....	20
EX-1280.....	11	DANTE INPUTS Page	20
Front Panel	11	LOCAL INPUTS & OUTPUTS Pages.....	21
Rear Panel	11	AmpLink Page.....	21
EX-440C.....	12	DANTE OUTPUTS Page.....	22
Front Panel	12	VoIP/Ph/USB Page.....	22
Rear Panel	12	CONFIG Menu.....	22
EX-1280C.....	13	NETWORK SETTINGS - CS Page	23
Front Panel	13	NETWORK SETTINGS - VoIP Page.....	23
Rear Panel	13	Dante Info Page	24
EX-12AEC	14	Firmware Versions Page.....	24
Front Panel	14	Design File Info page.....	25
Rear Panel	14	DISPLAY SETTINGS Page	25
Installation.....	15	Maintenance	26
1. Downloading & Installing ControlSpace Designer .	15	Firmware & Software Upgrades	26
2. Rack-mounting	15	Troubleshooting.....	26
3. Analog Audio Connections.....	16	Technical Information.....	28
4. AmpLink Connection	16	Technical Specifications.....	28
5. Dante Network Connection.....	17	EX-1280	28
6. Far-end Connections.....	17	EX-440C	30
VoIP.....	17	EX-1280C	32
Telephone.....	17	EX-12AEC.....	34
Soft Codecs.....	17	Telecom Compliance.....	35
7. Control Connections.....	18	FCC Compliance Statement	35
GPIO	18		
General-purpose Inputs	18		
General-purpose Outputs	18		
Serial.....	19		
CC-16	19		
8. Power Connection.....	19		
9. Configuration with ControlSpace Designer.....	19		

Overview

Package Contents

The product carton includes the following items, varying by model. Inspect all components for shipping damage and contact your Bose Professional representative if you find any issues.

Item		EX-1280	EX-440C	EX-1280C	EX-12AEC
	ControlSpace EX processor	1	1	1	1
	Power cord	1	1	1	1
	Euroblock connector (green, 6 pins, analog audio input)	6	2	6	0
	Euroblock connector (orange, 6 pins, analog audio output)	4	2	4	0
	Euroblock connector (green, 6 pins, general-purpose input)	1	0	1	0
	Euroblock connector (green, 2 pins, general-purpose input)	0	1	0	0
	Euroblock connector (orange, 6 pins, general-purpose output)	1	0	1	0
	Euroblock connector (black, 3 pins, serial)	1	1	1	0
	Euroblock connector (black, 3 pins, CC-16)	1	0	1	0
	Cable ties	16	6	16	0
	Installation guide	1	1	1	1

Available Accessories

The EX-1280, EX-440C, EX-1280C, and EX-12AEC processors are compatible with the Bose Professional controllers and endpoints listed below as well as ControlSpace Remote and controllers by other manufacturers such as Crestron® and AMX®.

Model	Part Number	Notes
ControlSpace EX-4ML mic/GPIO Dante endpoint	PC 771783	Uses Dante port. Requires EX Endpoint Power Supply (PC 800446) or Power-over-Ethernet (PoE) switch.
ControlSpace EX-8ML mic/GPIO Dante endpoint	PC 772045	Uses Dante port. Requires EX Endpoint Power Supply (PC 800446) or Power-over-Ethernet (PoE) switch.
ControlSpace EX-UH USB/Headset Dante endpoint	PC 771784	Uses Dante port. Requires EX Endpoint Power Supply (PC 800446) or Power-over-Ethernet (PoE) switch.
ControlSpace CC-64 control center	PC 041760	Provides network control of any Bose Professional networkable hardware.
ControlSpace CC-16 zone controller	PC 041761	Uses CC-16 port. Up to 15 devices can be used with the EX-1280 and EX-1280C.
ControlSpace ControlCenter CC-1D	PC 079059 (US, white) PC 079051 (US, black) PC 079042 (EU, white) PC 079070 (EU, black) PC 079062 (JP, white) PC 079060 (JP, black)	Uses Network port. Requires additional Power-over-Ethernet (PoE) switch.
ControlSpace ControlCenter CC-2D	PC 079063 (US, white) PC 079043 (US, black) PC 079071 (EU, white) PC 079049 (EU, black) PC 079066 (JP, white) PC 079046 (JP, black)	Uses Network port. Requires additional Power-over-Ethernet (PoE) switch.
ControlSpace ControlCenter CC-3D	PC 079061 (US, white) PC 079047 (US, black) PC 079053 (EU, white) PC 079058 (EU, black) PC 079041 (JP, white) PC 079064 (JP, black)	Uses Network port. Requires additional Power-over-Ethernet (PoE) switch.

EX-1280

Front Panel

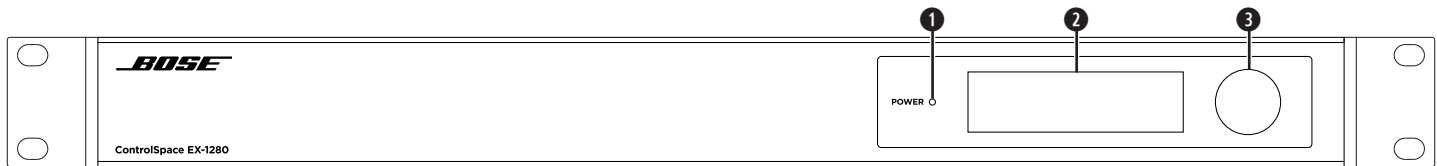

- ❶ **Power/Status indicator:** This LED illuminates white when the processor is powered on. The LED may blink white or change colors while the system is booting up. If the LED illuminates and remains red after the bootup is complete, please see **Maintenance > Troubleshooting** (page 26).
- ❷ **OLED Display:** This display provides metering and network information and settings. See **Operation** (page 20) for more information.
- ❸ **Rotary/Press Knob:** Turn and press this knob to navigate menus. See **Operation** (page 20) for more information.

Rear Panel

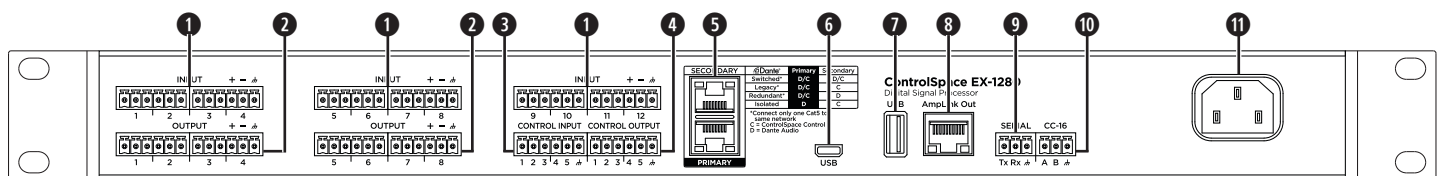

- ❶ **Analog audio inputs:** 12 balanced audio inputs (3.81 mm, 6-pin Euroblock). See **Installation > 3. Analog Audio Connections** (page 16) for more information.
- ❷ **Analog audio outputs:** 8 balanced audio outputs (3.81 mm, 6-pin Euroblock). See **Installation > 3. Analog Audio Connections** (page 16) for more information.
- ❸ **Control Inputs:** 5 inputs for general-purpose control (3.81 mm, 6-pin Euroblock). See **Installation > 7. Control Connections > GPIO > General-purpose Inputs** (page 18) for more information.
- ❹ **Control Outputs:** 5 outputs for general-purpose control (3.81 mm, 6-pin Euroblock). See **Installation > 7. Control Connections > GPIO > General-purpose Outputs** (page 18) for more information.
- ❺ **Dante ports:** 2 Ethernet ports for connection of Dante digital audio devices. See **Installation > 5. Dante Network Connection** (page 17) for more information.
- ❻ **Micro-B USB port:** Connect this port to a computer for use with soft codecs with stereo input and output. See **Installation > 6. Far-end Connections > Soft Codecs** (page 17) for more information.
- ❼ **USB port:** Not currently supported. Available for future updates to ControlSpace EX-1280.
- ❽ **AmpLink Out port:** RJ-45 connection for use with AmpLink-equipped amplifiers. See **Installation > 4. AmpLink Connection** (page 16) for more information.
- ❾ **Serial port:** 3-wire RS-232C (DTE) connection (3.81 mm, 3-pin Euroblock) to serial control interface. See **Installation > 7. Control Connections > Serial** (page 19) for more information.
- ❿ **CC-16 port:** 3-wire RS-485 connection (3.81 mm, 3-pin Euroblock) to Bose Professional CC-16 zone controller or other control interfaces. See **Installation > 7. Control Connections > CC-16** (page 19) for more information.
- ⓫ **Power input:** Power cord connection to AC mains power (IEC 60320-C14 inlet). See **Installation > 8. Power Connection** (page 19) for more information.

EX-440C

Front Panel

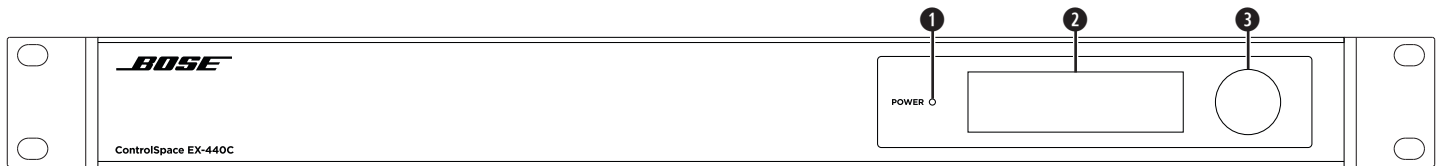

- ❶ **Power/Status indicator:** This LED illuminates white when the processor is powered on. The LED may blink white or change colors while the system is booting up. If the LED illuminates and remains red after the bootup is complete, please see **Maintenance > Troubleshooting** (page 26).
- ❷ **OLED Display:** This display provides metering and network information and settings. See **Operation** (page 20) for more information.
- ❸ **Rotary/Press Knob:** Turn and press this knob to navigate menus. See **Operation** (page 20) for more information.

Rear Panel

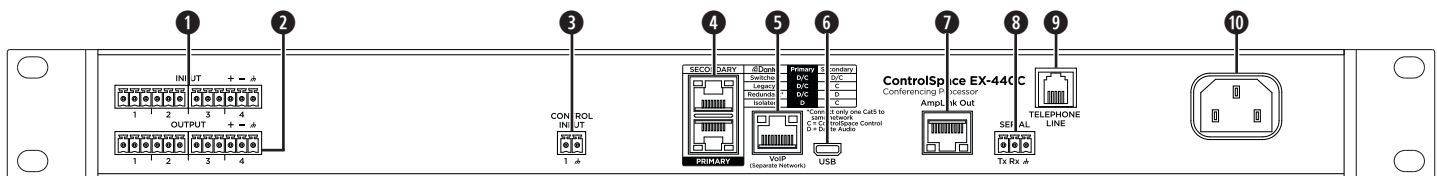

- ❶ **Analog audio inputs:** 4 balanced audio inputs (3.81 mm, 6-pin Euroblock), routable to automatic echo cancellation (AEC) using ControlSpace Designer software. See **Installation > 3. Analog Audio Connections** (page 16) for more information.
- ❷ **Analog audio outputs:** 4 balanced audio outputs (3.81 mm, 6-pin Euroblock). See **Installation > 3. Analog Audio Connections** (page 16) for more information.
- ❸ **Control Inputs:** 2 inputs for general-purpose control (3.81 mm, 6-pin Euroblock). See **Installation > 7. Control Connections > GPIO > General-purpose Inputs** (page 18) for more information.
- ❹ **Dante ports:** 2 Ethernet ports for connection of Dante digital audio devices. See **Installation > 4. Dante Network Connection** (page 17) for more information.
- ❺ **VoIP port:** RJ-45 port for communication via Voice-over-Internet-Protocol (SIP 2.0-compliant). See **Installation > 6. Far-end Connections > VoIP** (page 17) for more information.
- ❻ **Micro-B USB port:** Connect this port to a computer for use with soft codecs with stereo input and output. See **Installation > 6. Far-end Connections > Soft Codecs** (page 17) for more information.
- ❼ **AmpLink Out port:** RJ-45 connection for use with AmpLink-equipped amplifiers. See **Installation > 4. AmpLink Connection** (page 16) for more information.
- ❽ **Serial port:** 3-wire RS-232C (DTE) connection (3.81 mm, 3-pin Euroblock) to serial control interface. See **Installation > 7. Control Connections > Serial** (page 19) for more information.
- ❾ **Telephone Line port:** RJ-11 connection for analog telephone line. See **Installation > 6. Far-end Connections > Telephone** (page 17) for more information.
- ❿ **Power input:** Power cord connection to AC mains power (IEC 60320-C14 inlet). See **Installation > 8. Power Connection** (page 19) for more information.

EX-1280C

Front Panel

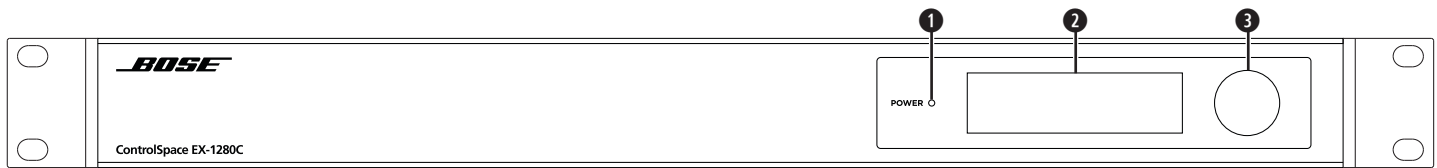

- ❶ **Power/Status indicator:** This LED illuminates white when the processor is powered on. The LED may blink white or change colors while the system is booting up. If the LED illuminates and remains red after the bootup is complete, please see **Maintenance > Troubleshooting** (page 26).
- ❷ **OLED Display:** This display provides metering and network information and settings. See **Operation** (page 20) for more information.
- ❸ **Rotary/Press Knob:** Turn and press this knob to navigate menus. See **Operation** (page 20) for more information.

Rear Panel

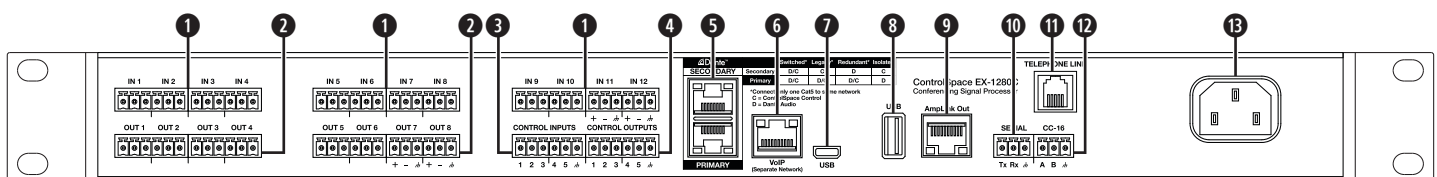

- ❶ **Analog audio inputs:** 12 balanced audio inputs (3.81 mm, 6-pin Euroblock), routable to automatic echo cancellation (AEC) using ControlSpace Designer software. See **Installation > 3. Analog Audio Connections** (page 16) for more information.
- ❷ **Analog audio outputs:** 8 balanced audio outputs (3.81 mm, 6-pin Euroblock). See **Installation > 3. Analog Audio Connections** (page 16) for more information.
- ❸ **Control Inputs:** 5 inputs for general-purpose control (3.81 mm, 6-pin Euroblock). See **Installation > 7. Control Connections > GPIO > General-purpose Inputs** (page 18) for more information.
- ❹ **Control Outputs:** 5 outputs for general-purpose control (3.81 mm, 6-pin Euroblock). See **Installation > 7. Control Connections > GPIO > General-purpose Outputs** (page 18) for more information.
- ❺ **Dante ports:** 2 Ethernet ports for connection of Dante digital audio devices. See **Installation > 5. Dante Network Connection** (page 17) for more information.
- ❻ **VoIP port:** RJ-45 port for communication via Voice-over-Internet-Protocol (SIP 2.0-compliant). See **Installation > 6. Far-end Connections > VoIP** (page 17) for more information.
- ❼ **Micro-B USB port:** Connect this port to a computer for use with soft codecs with stereo input and output. See **Installation > 6. Far-end Connections > Soft Codecs** (page 17) for more information.
- ❽ **USB port:** Not currently supported. Available for future updates to ControlSpace EX-1280C.
- ❾ **AmpLink Out port:** RJ-45 connection for use with AmpLink-equipped amplifiers. See **Installation > 4. AmpLink Connection** (page 16) for more information.
- ❿ **Serial port:** 3-wire RS-232C (DTE) connection (3.81 mm, 3-pin Euroblock) to serial control interface. See **Installation > 7. Control Connections > Serial** (page 19) for more information.
- ⓫ **Telephone Line port:** RJ-11 connection for analog telephone line. See **Installation > 6. Far-end Connections > Telephone** (page 17) for more information.
- ⓬ **CC-16 port:** 3-wire RS-485 connection (3.81 mm, 3-pin Euroblock) to Bose Professional CC-16 zone controller or other control interfaces. See **Installation > 7. Control Connections > CC-16** (page 19) for more information.
- ⓭ **Power input:** Power cord connection to AC mains power (IEC 60320-C14 inlet). See **Installation > 8. Power Connection** (page 19) for more information.

EX-12AEC

Front Panel

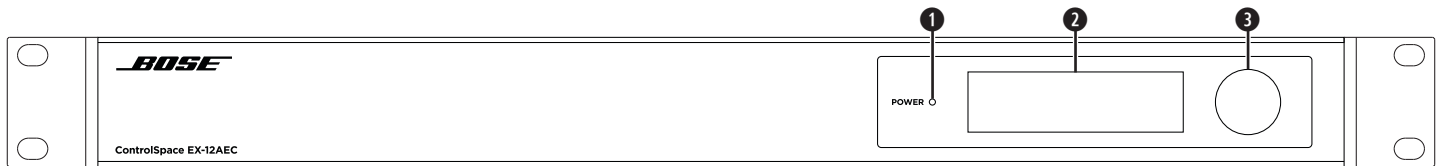

- ❶ **Power/Status indicator:** This LED illuminates white when the processor is powered on. The LED may blink white or change colors while the system is booting up. If the LED illuminates and remains red after the bootup is complete, please see **Maintenance > Troubleshooting** (page 26).
- ❷ **OLED Display:** This display provides metering and network information and settings. See **Operation** (page 20) for more information.
- ❸ **Rotary/Press Knob:** Turn and press this knob to navigate menus. See **Operation** (page 20) for more information.

Rear Panel

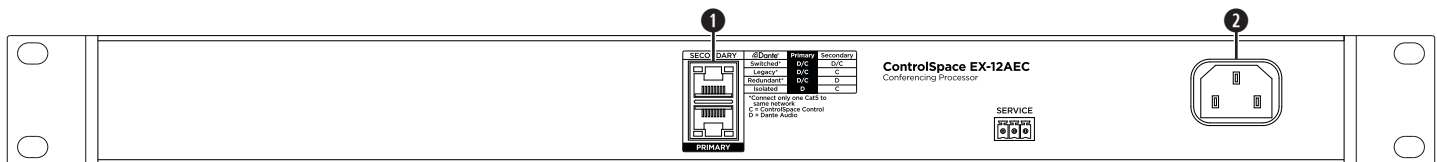

- ❶ **Dante ports:** 2 Ethernet ports for connection of Dante digital audio devices. See **Installation > 5. Dante Network Connection** (page 17) for more information.
- ❷ **Power input:** Power cord connection to AC mains power (IEC 60320-C14 inlet). See **Installation > 8. Power Connection** (page 19) for more information.

Installation

Follow the steps below when setting up a ControlSpace EX-1280, EX-440C, EX-1280C, or EX-12AEC for the first time. See the following sections for additional information about each step.

Note: *Due to the differences between the models, some of the installation steps may apply to certain models and not to others.*

1. Download and install the ControlSpace Designer software.
2. Mount the processor in a rack.
3. Make analog audio connections.
4. Connect an AmpLink-enabled amplifier.
5. Make Dante network connections.
6. Make far-end connections.
7. Make remote control and GPIO connections.
8. Connect the processor to a power outlet.
9. Configure the processor using ControlSpace Designer software.

1. Downloading & Installing ControlSpace Designer

Download and install ControlSpace Designer software to a computer (Windows only) on the same local subnet as the processor. Visit **BoseProfessional.com** to download the latest software version, which includes product firmware, the latest algorithms, and a detailed help system to guide system designers and installers through configuring the processor for use in high-quality audio systems.

2. Rack-mounting

The processor is designed to fit standard 19-inch (48-centimeter) rack equipment, occupying one rack unit (1RU) in height, and requires a mounting depth of 10.5 inches (26.7 centimeters) from the front rack rail. Use four fasteners with washers (not included) to mount the processor.

The product uses two variable-speed fans and can safely operate in ambient conditions from 0 °C to 40 °C (32 °F to 104 °F). Refer to the **Technical Information > Technical Specifications** (page 28) for power dissipation ratings.

CAUTION: *Only use the mounting hardware recommended by the rack manufacturer.*

CAUTION: *Due to ventilation requirements, ensure proper enclosure ventilation if the unit is installed in an enclosed space such as a cabinet or credenza.*

3. Analog Audio Connections

The EX-1280, EX-440C, and EX-1280C include balanced dual-channel (3.81 mm pitch) Euroblock connectors for analog audio connections. The termination end of each connector includes printed terminal block descriptions.

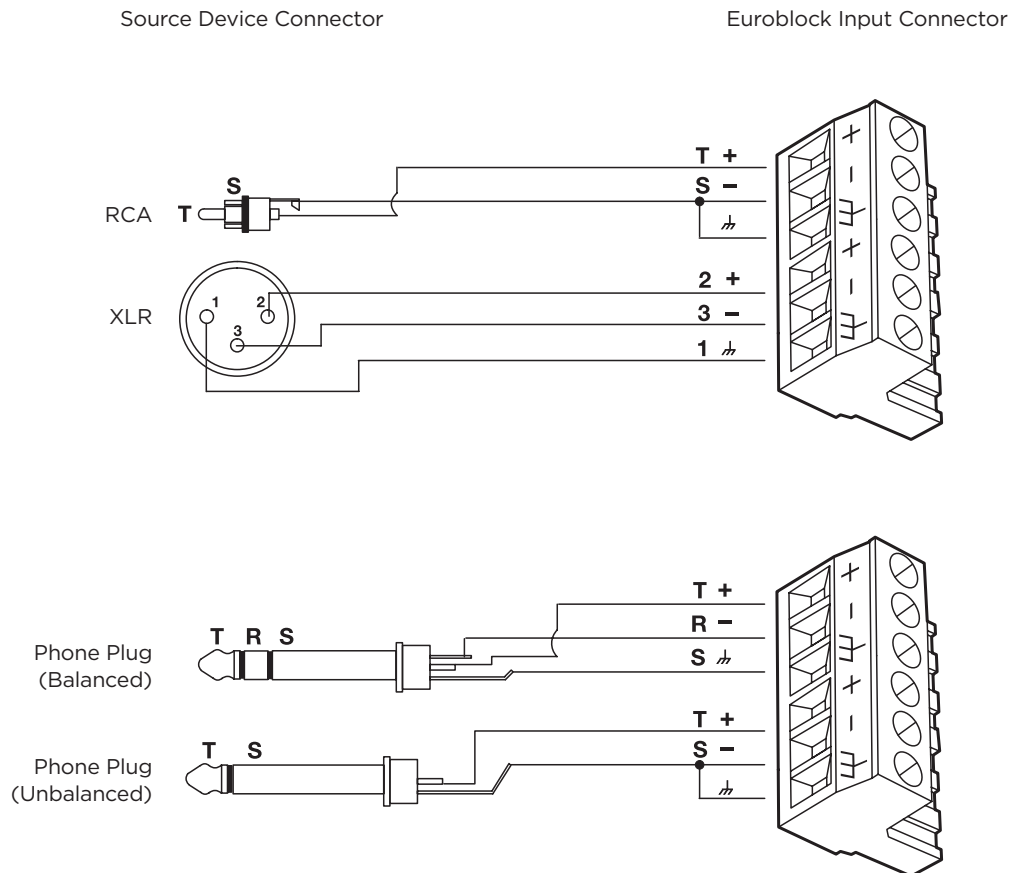

4. AmpLink Connection

If you are using a Bose Professional AmpLink-enabled amplifier, connect the **AmpLink** port (RJ-45) on the EX-1280, EX-440C, or EX-1280C to the amplifier's **AmpLink** port using a shielded Cat 5 cable.

CAUTION: Shielded EIA/TIA 568B straight Cat 5 cable, or equivalent, is required for proper AmpLink operation. Unshielded cable is not supported and may cause AmpLink audio to operate improperly.

AmpLink Out

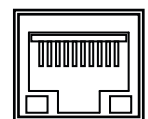

The EX-440C transmits on the first four AmpLink channels. The EX-1280 and EX-1280C transmit on the first eight AmpLink channels. Select the corresponding channels on the amplifier using the amplifier's rear-panel switch settings.

5. Dante Network Connection

The rear panel of the processor includes two **Dante** network ports (**Primary** and **Secondary**), which provide input and output channels of low-latency digital audio using Dante audio networking technology. These ports can be configured for switched (default), redundant, isolated, or filtered network connections using Dante Controller by Audinate.

The EX-1280 and EX-1280C support 64 input channels and 64 output channels. The EX-440C and EX-12AEC support 16 input channels and 16 output channels.

You can use these same network ports to control and configure the processor while using ControlSpace Designer software. Connect the proper **Dante** port to a computer either directly or through an Ethernet switch. Ensure that the computer is on the same subnet as the processor using one of the following three methods:

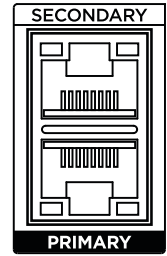

Set the computer to DHCP and connect a DHCP server to the network. Both the processor and the computer will obtain an IP address from the DHCP server.

Set the computer to DHCP and without a DHCP server. Both the processor and the computer will obtain an AutoIP-assigned IP address.

Set the computer to a static IP address and use the processor's front-panel **display** and **knob** to assign the processor a static address on the same subnet.

For more information, see the help system for ControlSpace Designer.

The control and audio signals for each type of network connection are configured in the following way for each port:

Connection	Primary Port	Secondary Port	
Switched*	D/C	D/C	
Legacy*	D/C	C	* Connect only 1 Cat 5 cable to the same network
Redundant*	D/C	D	D: Dante audio
Isolated	D	C	C: ControlSpace control

6. Far-end Connections



CAUTION: To reduce the risk of fire, use only No. 26 AWG (0.41 mm Ø / 0.13 mm²) or larger telecommunication line cord.

ATTENTION : Pour réduire les risques d'incendie, utiliser uniquement des conducteurs de télécommunications 26 AWG (0.41 mm Ø / 0.13 mm²) au de section supérieure.

VoIP

Use a Cat 5 cable to connect the **VoIP** port (RJ-45) on the EX-440C or EX-1280C to a compatible session-initiation-protocol (SIP) IP private branch exchange (PBX).

For information on configuring the VoIP connection, see the help system for ControlSpace Designer.

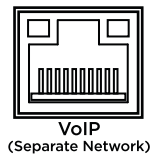

Telephone

Use a RJ-11 cable to connect the **Telephone Line** port on the EX-440C or EX-1280C to an analog telephone line.



Soft Codecs

Use a USB cable to connect the **micro-B USB port** on the EX-1280, EX-440C, or EX-1280C to a computer. You can use soft codecs (with EX-440C or EX-1280C) or PC applications (with EX-1280) with stereo input and output over this connection.



7. Control Connections

The rear panels of the EX-1280, EX-440C, and EX-1280C include various connections for compatible controllers:

The EX-1280, EX-440C, and EX-1280C include general-purpose connections (**Control Inputs** or **Control Outputs**) for external control hardware.

The EX-1280, EX-440C, and EX-1280C include a RS-232 port (**Serial**) for connecting industry-standard serial control systems.

The EX-1280 and EX-1280C include an RS-485 port (**CC-16**) for compatible Bose Professional controllers.

GPIO

Use the rear-panel general-purpose input/output (GPIO) connections to interface the processor with external control hardware.

The EX-1280 and EX-1280C include five general-purpose inputs and five general-purpose outputs.

The EX-440C includes one general-purpose input.

General-purpose Inputs

General-purpose control input ports are used to connect external hardware such as potentiometers (to control levels or gains) and switches (to set logic states). Use ControlSpace Designer to easily assign functions to these external controls.

Using Switches

Both toggle switches and pushbuttons can be used with control inputs. Each input terminal is tied to an internal two-kiloohm pull-up resistor so that external switches can be wired directly from input to ground.

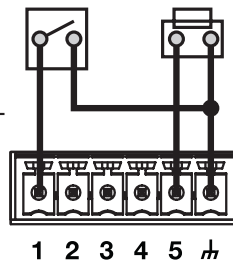

Using Potentiometers

10 kilohm potentiometers can be connected and associated with control gain blocks in a system design. Inputs are compatible (through ControlSpace Designer) with linear-taper potentiometers wired for minimum resistance at the fully clockwise position or at the fully counter-clockwise position.

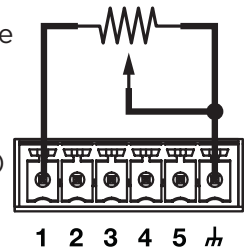

General-purpose Outputs

Current Source Devices

Some devices such as LEDs and low-current relays can be powered directly from control outputs. A maximum source current of 10 milliamps is available.

Source Limits: 8 VDC, 10 mA (max.)

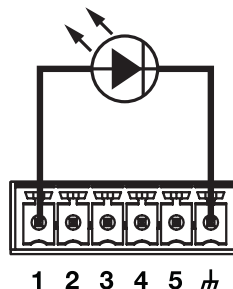

Current Sink Devices

Devices that require more current than is available from a current-source configuration can use control outputs to sink up to 100 milliamps when used with external power supplies. Use proper precautions when driving inductive loads.

Sink Limits: 100 mA (max.). External supplies must be ≤ 24 VDC.

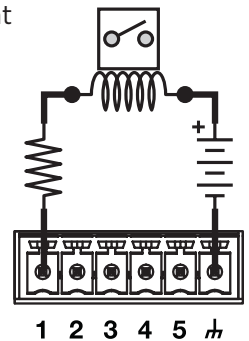

Serial

Using the included 3-pin Euroblock connector, connect industry-standard RS-232 control systems to the **Serial** port on the EX-1280, EX-440C, or EX-1280C.

The 3-pin connector on the processor corresponds to a DB-9 connector pinouts as follows:



Serial Port	DB-9 Connector Pinout
Tx	Pin 2 (Receive Data)
Rx	Pin 3 (Transmit Data)
⏏ (Ground)	Pin 5 (Ground)

CC-16

Using the included 3-pin Euroblock connector, connect a ControlSpace CC-16 zone controller to the **CC-16** port on the EX-1280 or EX-1280C. For more information on how to wire these connections, see the CC-16 installation guide available at BoseProfessional.com.

You can network up to 15 CC-16 zone controllers to control the EX-1280, EX-1280C, or any device on the ControlSpace control network. An external power supply is required.

In addition to wiring the **A** and **B** terminals, we recommend connecting the **ground** terminal from the **CC-16** port EX-1280 or EX-1280C to each CC-16 zone controller. The maximum recommended distance between the processor and any CC-16 is 610 meters (2,000 feet).

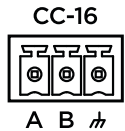

8. Power Connection

The processor can operate with AC mains line voltages from 100 volts to 240 volts at 50 Hz/60 Hz over a detachable IEC power cord. Power consumption is 37 volt-amperes at an ambient temperature of 40 °C (104 °F).

To power on the processor, use the included power cord to connect the processor's power inlet to a power outlet. After powering on, the boot time may be as long as 40 seconds. The processor is fully operable when the **Power/Status** LED on the front panel is lit solid white.

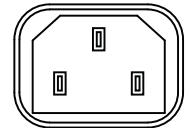

Note: Make all audio and network connections before connecting the power cord.

9. Configuration with ControlSpace Designer

If all the network connections and settings are configured correctly, ControlSpace Designer will automatically identify the processor on the network.

To scan and update the processor's firmware, use the **Hardware Manager** tool in ControlSpace Designer. Once **Up-to-Date** appears as the **Status** for the processor, proceed with your system design using ControlSpace Designer.

For details on using ControlSpace Designer to configure, control, and monitor the processor or entire systems built with Bose Professional networked system electronics, see the help system for ControlSpace Designer.

Operation

Display Menus & Pages

The processor’s front-panel display shows several menus and pages that can be used to view and change network settings, display metering for any audio input or output, and change display settings.

This section describes each menu item and the options. The menu layouts and available options vary by processor model where indicated.

To select an item, turn the **knob** until the item is highlighted in the **display**.

To open the selected item, push the **knob**.

To return to the **Main** menu, turn the **knob** counter-clockwise until it appears.

Main Menu

The Main menu offers six options. Selecting an option opens the corresponding page or menu. See the following sections to learn more about each one.



DANTE INPUT: The DANTE INPUTS page.

LOCAL IN/OUT: The LOCAL INPUTS and LOCAL OUTPUTS pages (EX-1280, EX-440C, and EX-1280C only).

AMPLink: The AmpLink page (EX-1280, EX-440C, and EX-1280C only).

DANTE OUTPUT: The DANTE OUTPUTS page.

VoIP/Phone/USB: The VoIP/Ph/USB page (EX-1280, EX-440C, and EX-1280C only).

CONFIG: The CONFIG menu.

DANTE INPUTS Page

The DANTE INPUTS page displays audio levels (-60 dBu to +24 dBu) for each available Dante input channel.

Channels 1-32 appear on the first page. To view Channels 33-64, turn the **knob** clockwise.

The EX-440C and EX-12AEC use Channels 1-16.

The EX-1280 and EX-1280C use Channels 1-64.

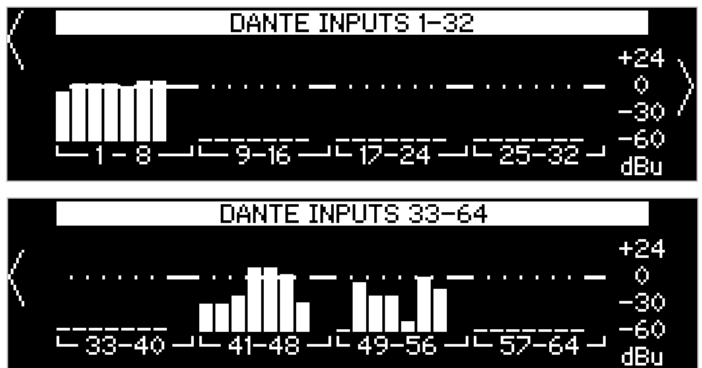

LOCAL INPUTS & OUTPUTS Pages

The local inputs appear on the first page.

The EX-440C uses Channels 1-4.

The EX-1280 and EX-1280C use Channels 1-12.

To view the local outputs, turn the **knob** clockwise.

The EX-440C uses Channels 1-4.

The EX-1280 and EX-1280C use Channels 1-8.

The LOCAL INPUTS page displays the following information for analog Input Channels 1-12:

Audio level (-60 dBu to +24 dBu).

PH POWER: An open circle indicates that there is no phantom power applied to the corresponding input channel. A closed circle indicates that phantom power is applied to the corresponding input channel. Use ControlSpace Designer to apply or remove phantom power to or from each channel.

MUTE: An open circle indicates that the corresponding input channel is not muted. A closed circle indicates that the corresponding input channel is muted. Use ControlSpace Designer to set the mute status for each channel.

The LOCAL OUTPUTS page displays the following information for analog Output Channels 1-8:

Audio level (-60 dBu to +24 dBu).

POLARITY: A plus (+) symbol indicates a positive polarity. A minus (-) symbol indicates a negative polarity. Use ControlSpace Designer to set the polarity of each channel.

MUTE: An open circle indicates that the corresponding output channel is not muted. A closed circle indicates that the corresponding output channel is muted. Use ControlSpace Designer to set the mute status for each channel.

AmpLink Page

The AmpLink page displays audio levels (-60 dBu to +24 dBu) for AmpLink Output Channels 1-8.

The EX-440C uses Channels 1-4.

The EX-1280 and EX-1280C use Channels 1-8.

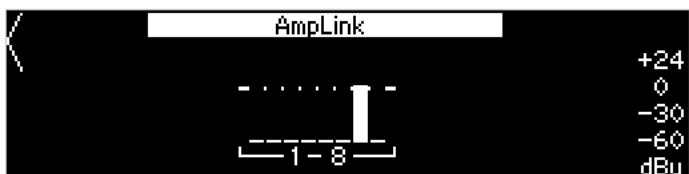
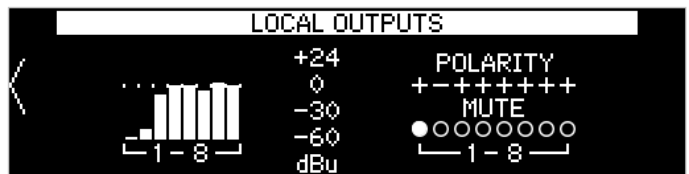

DANTE OUTPUTS Page

The DANTE OUTPUTS page displays audio levels (-60 dBu to +24 dBu) for each available Dante output channel.

Channels 1-32 appear on the first page. To view Channels 33-64, turn the **knob** clockwise.

- The EX-440C and EX-12AEC use Channels 1-16.
- The EX-1280 and EX-1280C use Channels 1-64.

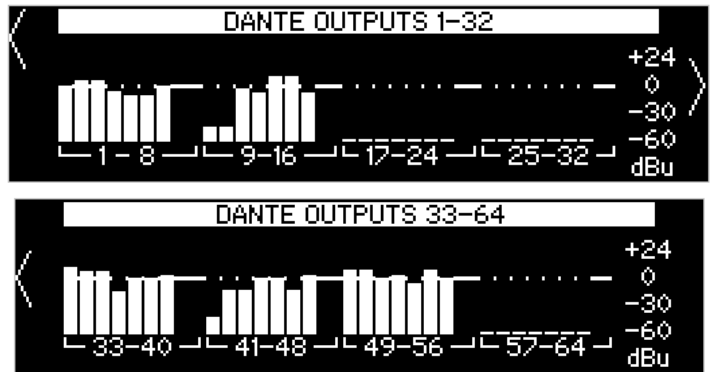

VoIP/Ph/USB Page

The VoIP/Ph/USB page displays audio levels (-60 dBu to +24 dBu) for the following channels:

- VoIP > I/O-1:** VoIP Input/Output Channel 1 (EX-440C and EX-1280C only).
- VoIP > I/O-2:** VoIP Input/Output Channel 2 (EX-1280C only).
- Ph > I/O:** Phone Input/Output (EX-440C and EX-1280C only).
- USB > L/R-IN:** USB Left/Right In (EX-1280, EX-440C, and EX-1280C only).
- USB > L/R-OUT:** USB Left/Right Out (EX-1280, EX-440C, and EX-1280C only).

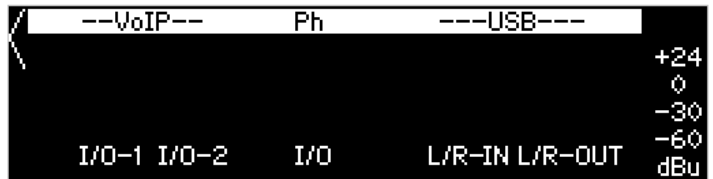

CONFIG Menu

The CONFIG menu offers six options. Selecting an option opens the corresponding page. See the following sections to learn more about each page.

- CS NETW SETTINGS:** The NETWORK SETTINGS - CS page.
- VoIP NETW SETTINGS:** The NETWORK SETTINGS - VoIP page (EX-440C and EX-1280C only).
- DANTE INFO:** The Dante Info page.
- VERSION INFO:** The Firmware Versions page.
- DESIGN FILE INFO:** The Design File Info page.
- DISPLAY SETTINGS:** The DISPLAY SETTINGS page.



To return to the **CONFIG** menu from each of its pages, turn the **knob** counter-clockwise until the arrow in the upper-left corner of the display is selected, and then press the **knob**. You will be prompted to save or discard any changes you have made on the page.

To discard your changes, turn the **knob** to select **NO** (the default), and then press the **knob**.

To save the changes you made, turn the **knob** to select **YES**, and then press the **knob**. Your changes will be saved, and the processor will reboot automatically.

CONFIG > NETWORK SETTINGS - CS Page

The CS NETW SETTINGS page displays ControlSpace network settings, some of which you can edit.

To select an setting, turn the **knob** until an arrow appears next to the setting's name.

To edit the selected setting, press the **knob**.

To confirm the selected setting after editing it, press the **knob**.

The ControlSpace network settings are:

MODE: The IP mode, which you can set to **DHCP** or **STATIC**.

IP ADDRESS: The processor's IP address, which you can set by address block. Turn the **knob** to move between the four address blocks.

SUBNET MASK: The processor's subnet mask address, which you can set by address block. Turn the **knob** to move between the four address blocks.

GATEWAY: The processor's gateway address, which you can set by address block. Turn the **knob** to move between the four address blocks.

MAC ADDRESS: The processor's MAC address. You cannot edit this setting.



NETWORK SETTINGS - CS	
MODE	DHCP
IP ADDRESS	192 168 0 160
SUBNET MASK	255 255 255 0
GATEWAY	192 168 0 1
MAC ADDRESS	00:0c:8a:78:00:25

CONFIG > NETWORK SETTINGS - VoIP Page

The VoIP NETW SETTINGS page displays VoIP network settings, some of which you can edit. This is available on the EX-440C and EX-1280C only.

To select an setting, turn the **knob** until an arrow appears next to the setting's name.

To edit the selected setting, press the **knob**.

To confirm the selected setting after editing it, press the **knob**.

The VoIP network settings are:

MODE: The IP mode, which you can set to **DHCP** or **STATIC**.

IP ADDRESS: The IP address of the processor's VoIP card, which you can set by address block. Turn the **knob** to move between the four address blocks.

SUBNET MASK: The subnet mask address of the processor's VoIP card, which you can set by address block. Turn the **knob** to move between the four address blocks.

GATEWAY: The gateway address of the processor's VoIP card, which you can set by address block. Turn the **knob** to move between the four address blocks.

MAC ADDRESS: The MAC address of the processor's VoIP card. You cannot edit this setting.

VLAN: The optional VLAN number.



NETWORK SETTINGS - VoIP	
MODE	DHCP
IP ADDRESS	192 168 0 160
SUBNET MASK	255 255 255 0
GATEWAY	192 168 0 1
MAC ADDRESS	00:0c:8a:78:00:26
VLAN	0

CONFIG > Dante Info Page

The Dante Info page displays settings that correspond to what is displayed in the Dante controller software. You cannot edit these settings.

The settings are:

IP: The IP address of the processor's Dante card.

MAC ADDRESS: The MAC address of the processor's VoIP card.

Ch Num: The number of available Dante channels (inputs × outputs).

MODE: The current Dante device network configuration. You can use ControlSpace Designer to set this to **SWITCHED**, **LEGACY**, **REDUNDANT**, or **ISOLATED**. See the help system for ControlSpace Designer to learn about these modes.

ID: The name of the product.

Device: The assigned name of the Dante device. You can use ControlSpace Designer or the Dante controller to set this name.

Fact Model: The version number of the processor's boot ROM.

Fact SW: The version number of the processor's software.

Fact FW: The version number of the processor's firmware.

SW: The version number of the processor's Audinate Dante software.

FW: The version number of the processor's Audinate Dante firmware.

Dante Info			
IP	192.168.0.53	Fact Model	1.0.6
MAC	00:1d:c1:0e:d6:92	Fact SW	1.0.0
Ch Num	64x64	Fact FW	1.0.0 Build 6
MODE	SWITCHED	SW	3.9.6
ID	EX-1280C	FW	4.0.0
Device	BKLYN-II-0ed692		

CONFIG > Firmware Versions Page

The Firmware Versions page displays the version numbers of the software and/or firmware for these components of the processor:

FW: The processor's firmware.

DSP: The processor's software that manages its digital signal processing.

AEC: The processor's software that manages its acoustic echo cancellation (EX-440C, EX-1280C, and EX-12AEC only).

PSTN: The processor's software that manages its PSTN functions (EX-440C and EX-1280C only).

Dante: The processor's software that manages its Dante network functions.

Kernel: The processor's operating system kernel.

VoIP: The processor's software that manages its VoIP functions (EX-440C and EX-1280C only).

Num Ch: The number of available Dante channels (inputs × outputs).

Firmware Versions	
FW:	v1.0.0, build: 1
DSP:	App:0.39.0b0,Com:0.18.0b0,Alg:0.34.0b0
AEC:	1.0.3 (12 microphone channels)
PSTN:	v1.00 VoIP: v1.8.0
Dante:	1.0.6 Num Ch: 64x64
Kernel:	1.0.00

CONFIG > Design File Info page

The Design File Info page displays the following information about the most recent ControlSpace Designer design file uploaded to the processor:

Device Name: The device name. You can set this in the design file in ControlSpace Designer.

Last Upload: The date and time the most recent design file was uploaded.

File Size: The size of the most recently uploaded design file.

RTC Master?: Indication of whether or not this device is the real-time control (RTC) master for the system. You can set this in the design file in ControlSpace Designer.

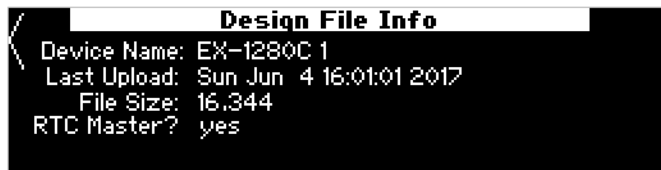
**CONFIG > DISPLAY SETTINGS Page**

The DISPLAY SETTINGS page displays information about the front-panel display, which you can edit.

To select an setting, turn the **knob** until an arrow appears next to the setting's name.

To edit the selected setting, press the **knob**.

To confirm the selected setting after editing it, press the **knob**.

The display settings are:

Display auto-shutoff: The time (in minutes) that the processor's front-panel display must be inactive before turning off (this does not affect the processor's normal operation).

Brightness: The brightness of the front-panel display.



Maintenance

Firmware & Software Upgrades

Bose Professional periodically releases updates of the ControlSpace Designer software. Please check **BoseProfessional.com** for these software updates.

For information on how to update the firmware for the processor, see the help system for ControlSpace Designer.

Troubleshooting

Problem	Solution
The processor cannot power on.	Use the included power cord to connect the processor's power inlet (on the rear panel) to a power outlet. Verify that the mains power is active.
The power is on, but there is no sound.	Verify that there is an input signal from the source using ControlSpace Designer. The audio input metering should be in the green/yellow band. Verify that there is an output signal. The audio output signal metering should be in the green/yellow band.
The sound is distorted.	Using ControlSpace Designer, verify that the audio input signal indicator blocks are not showing solid red or flashing red. If they are, reduce the input pre-gain setting to where the input is no longer clipping (red). Using ControlSpace Designer, verify that the audio output signal indicator blocks are not solid red or flashing red. If they are, and if the input indicators are green, use ControlSpace Designer to reduce the output gain or any intermediary gain in the signal path. If the input and output indicators are green, and if you are sure the output volume of the audio device is undistorted when it enters the system, verify that the loudspeakers are not being overdriven and are not damaged.
The processor does not appear on the same network as the computer when using ControlSpace Designer.	Verify that the processor is fully booted. The Power/Status indicator on the front panel should appear solid white. Verify that the LAN settings on the TCP/IP Ethernet device you are using on the computer are set correctly: If you are not using a DHCP server, manually set the computer's IP address to an unused IP address (e.g. 192.168.0.2). The default IP subnet mask should be set to 255.255.255.0 . Open the firewall settings on the computer, and unblock all ports. Open the Hardware Manager in ControlSpace Designer, and verify that the proper Host Network Interface Card Name is selected. Verify that there is not another device connected to the network with the same IP address. See the help system for ControlSpace Designer for detailed steps to ensure the processor is on the same network as the computer.

Problem	Solution
<p>Power/Status indicator remains red after booting.</p>	<p>This is most often the result of an incompatibility between the design file and firmware version. To fix this, retrieve the saved design from the processor (if you have not already saved it to your computer), and then upload a blank design file to the processor. The Power/Status indicator should change to white. Import the saved design file into the latest version of ControlSpace Designer. After that, save the design file, and then upload it to the processor.</p>
<p>The processor does not indicate any network connectivity.</p>	<p>Verify the processor's ControlSpace port (on the rear panel) is connected to the network.</p> <p>Verify that the network activity LED built into the ControlSpace port (on the rear panel) is lit or blinking to confirm an active network connection.</p>
<p>The front-panel display shows the NETWORK SETTINGS - CS page with an unexpected IP address of 169.x.x.x or 172.x.x.x.</p>	<p>If the processor's IP mode is set to DHCP when no DHCP server is on the network, the processor will use these ranges by default. Add a DHCP server to the network, or change the processor's IP address to a static IP address.</p>
<p>A connected AmpLink-enabled amplifier is not receiving AmpLink audio signal from the processor.</p>	<p>Verify that the connection cable is a shielded Cat 5 network cable, and set the amplifier to receive AmpLink Channels 1-4 (EX-440C) or Channels 1-8 (EX-1280 and EX-1280C).</p>
<p>The processor does not register any Dante audio subscriptions (connections) or audio signals.</p>	<p>Verify that the IP address of the processor's Dante card is on the same network as the processor's ControlSpace control IP address. To do this, view the Dante Info page (see page 24 for more information). To change the IP address of the processor's Dante card, use Audinate's Dante Controller software. It can also be helpful to change the computer's network settings from a static IP mode to a DHCP mode to view and change the IP address of the Dante card.</p>

Technical Information

Technical Specifications

EX-1280

Integrated DSP	
Signal Processor	32-bit fixed/floating-point DSP 456 MHz/Arm Cortex-A8 600 MHz
Maximum Calculation	3.6 GIPS / 2.7 GFLOPS
Delay	43 s
Audio Latency	1.05 ms (analog in to analog out)
A/D & D/A Converters	24-bit
Sample Rate	48 kHz
Analog Audio Inputs	
Input Channels	12 balanced, mic/line level
Input Connectors	3.81 mm, 6-pin Euroblock
Input Impedance	12 k Ω at 1 kHz (with or without phantom power active)
Maximum Input Level	+24 dBu
Equivalent Input Noise	-118 dB at 44 dB gain setting
Phantom Power	+48 VDC, 10 mA, selectable per input
Gain Settings	0/+14/+24/+32/+44/+54/+64 dB
Analog Audio Outputs	
Output Channels	8 balanced, line-level
Output Connectors	3.81 mm, 6-pin Euroblock
Output Impedance	200 Ω
Maximum Output Level	+24 dBu
Audio Performance	
Frequency Response	20 Hz to 20 kHz (+0.5 dB/-0.5 dB)
THD+N	0.01% at +4 dBu (A-weighted, 20 Hz to 20 kHz)
Channel Separation (Crosstalk)	< -105 dB at +4 dBu input & output level, 1 kHz
Dynamic Range	> 115 dB, A-weighted, 20 Hz to 20 kHz, analog input to analog output
Audio Over IP	
Dante	64 \times 64, primary/secondary
Digital Audio Outputs	
AmpLink (output only)	8 ultra-low latency (< 21 μ s), 48 kHz; requires shielded Cat 5 cable
Communication Ports	
USB Device	Micro-B type, stereo in/out, HID support
USB Host	Type A; for future use

Control Inputs	
Inputs & Connectors	5 analog or digital inputs, 2 k Ω internal pull-up resistor to 5 V, 3.81 mm, 6-pin Euroblock
Voltage Range	Analog Inputs: 0 V to 3.3 V (maximum: 5 V) Digital Inputs: 0 V to 3.3 V (threshold voltage: 1.6 V)
Control Outputs	
Outputs & Connectors	5 digital outputs, 3.81 mm, 6-pin Euroblock
Output Voltage	High: 8 V (open circuit), 2.5 V at 10 mA Low: < 1 V at 100 mA, push-pull
Indicators & Controls	
Display	256 \times 64 OLED with rotary/push encoder
LED Status Indicators	Power/Status
Audio Signal Indication	On display
Electrical	
Mains Voltage	100 VAC to 240 VAC, 50/60 Hz
AC Power Consumption	35 W typical at 40 $^{\circ}$ C (104 $^{\circ}$ F) ambient
Mains Connector	IEC 60320-C14 (inlet)
Power Dissipation	60 W (205 BTU, 52 kcal)
Physical	
Dimensions (H \times W \times D)	44 mm \times 483 mm \times 282 mm (1.7 in \times 19.0 in \times 11.1 in)
Net Weight	3.2 kg (7.1 lb)
Operating Temperature	0 $^{\circ}$ C to 40 $^{\circ}$ C (32 $^{\circ}$ F to 104 $^{\circ}$ F)
Cooling System	2 variable-speed fans, side venting
General	
PC Configuration Software	ControlSpace Designer
Network Control	Ethernet (RJ-45), 1 Gbps
RS-232/485 Ports	RS-232 (DTE) & Bose Professional CC-16 (RS-485 master); 3.81 mm, 3-pin Euroblock

EX-440C

Integrated DSP	
Signal Processor/CPU	32-bit fixed/floating-point DSP 456 MHz/Arm Cortex-A8 600 MHz
Maximum Calculation	3.6 GIPS / 2.7 GFLOPS
Delay	43 s
Audio Latency	1.05 ms (analog in to analog out, without AEC)
A/D & D/A Converters	24-bit
Sample Rate	48 kHz
Acoustic Echo Cancellation	
Tail Length	480 ms
Noise Reduction	32 dB
Latency	50 ms
Channels	8
References	4
Analog Audio Inputs	
Input Channels	4 balanced, mic/line level
Input Connectors	3.81 mm, 6-pin Euroblock
Input Impedance	12 k Ω at 1 kHz (with or without phantom power active)
Maximum Input Level	+24 dBu
Equivalent Input Noise	-118 dB at 44 dB gain setting
Phantom Power	+48 VDC, 10 mA, selectable per input
Gain Settings	0/+14/+24/+32/+44/+54/+64 dB
Analog Audio Outputs	
Output Channels	4 balanced, line-level
Output Connectors	3.81 mm, 6-pin Euroblock
Output Impedance	200 Ω
Maximum Output Level	+24 dBu
Audio Performance	
Frequency Response	20 Hz to 20 kHz (+0.5 dB/-0.5 dB)
THD+N	0.01% at +4 dBu (A-weighted, 20 Hz to 20 kHz)
Channel Separation (Crosstalk)	< -105 dB at +4 dBu input & output level, 1 kHz
Dynamic Range	> 115 dB, A-weighted, 20 Hz to 20 kHz, analog input to analog output

Audio Over IP	
Dante	16 × 16, primary/secondary, routable to AEC
Digital Audio Outputs	
AmpLink (output only)	4 ultra-low latency (< 21 μs), 48 kHz; requires shielded Cat 5 cable
Communication Ports	
USB Device	Micro-B type, stereo in/out, HID support
VoIP	RJ-45; 1 line
PSTN	RJ-11; 1 line, Tx/Rx
Control Inputs	
Inputs & Connectors	1 analog or digital input, 2 kΩ internal pull-up resistor to 5 V, 3.81 mm, 2-pin Euroblock
Voltage Range	Analog Inputs: 0 V to 3.3 V (maximum: 5 V) Digital Inputs: 0 V to 3.3 V (threshold voltage: 1.6 V)
Indicators & Controls	
Display	256 × 64 OLED with rotary/push encoder
LED Status Indicators	Power/Status
Audio Signal Indication	On display
Electrical	
Mains Voltage	100 VAC to 240 VAC, 50/60 Hz
AC Power Consumption	35 W typical at 40 °C (104 °F) ambient
Mains Connector	IEC 60320-C14 (inlet)
Power Dissipation	60 W (205 BTU, 52 kcal)
Physical	
Dimensions (H × W × D)	44 mm × 483 mm × 282 mm (1.7 in × 19.0 in × 11.1 in)
Net Weight	3.2 kg (7.1 lb)
Operating Temperature	0 °C to 40 °C (32 °F to 104 °F)
Cooling System	2 variable-speed fans, side venting
General	
PC Configuration Software	ControlSpace Designer
Network Control	Ethernet (RJ-45), 1 Gbps
RS-232/485 Ports	RS-232 (DTE); 3.81 mm, 3-pin Euroblock

EX-1280C

Integrated DSP	
Signal Processor	32-bit fixed/floating-point DSP 456 MHz/Arm Cortex-A8 600 MHz
Maximum Calculation	3.6 GIPS / 2.7 GFLOPS
Delay	43 s
Audio Latency	1.05 ms (analog in to analog out, without AEC)
A/D & D/A Converters	24-bit
Sample Rate	48 kHz
Analog Audio Inputs	
Input Channels	12 balanced, mic/line level
Input Connectors	3.81 mm, 6-pin Euroblock
Input Impedance	12 kΩ at 1 kHz (with or without phantom power active)
Maximum Input Level	+24 dBu
Equivalent Input Noise	-118 dB at 44 dB gain setting
Phantom Power	+48 VDC, 10 mA, selectable per input
Gain Settings	0/+14/+24/+32/+44/+54/+64 dB
Analog Audio Outputs	
Output Channels	8 balanced, line-level
Output Connectors	3.81 mm, 6-pin Euroblock
Output Impedance	200 Ω
Maximum Output Level	+24 dBu
Audio Performance	
Frequency Response	20 Hz to 20 kHz (+0.5 dB/-0.5 dB)
THD+N	0.01% at +4 dBu (A-weighted, 20 Hz to 20 kHz)
Channel Separation (Crosstalk)	< -105 dB at +4 dBu input & output level, 1 kHz
Dynamic Range	> 115 dB, A-weighted, 20 Hz to 20 kHz, analog input to analog output
Audio Over IP	
Dante	64 × 64, primary/secondary
Digital Audio Outputs	
AmpLink (output only)	8 ultra-low latency (< 21 μs), 48 kHz; requires shielded Cat 5 cable
Communication Ports	
USB Device	Micro-B type, stereo in/out, HID support
VoIP	RJ-45; 2 lines, 2 instances per line
PSTN	RJ-11; 1 line, Tx/Rx
USB Host	Type A; for future use

Control Inputs	
Inputs & Connectors	5 analog or digital inputs; 2 k Ω internal pull-up resistor to 5 V, 3.81 mm, 6-pin Euroblock
Voltage Range	Analog Inputs: 0 V to 3.3 V (maximum: 5 V) Digital Inputs: 0 V to 3.3 V (threshold voltage: 1.6 V)
Control Outputs	
Outputs & Connectors	5 digital outputs, 3.81 mm, 6-pin Euroblock
Output Voltage	High: 8 V (open circuit), 2.5 V at 10 mA Low: < 1 V at 100 mA, push-pull
Indicators & Controls	
Display	256 × 64 OLED with rotary/push encoder
LED Status Indicators	Power/Status
Audio Signal Indication	On display
Electrical	
Mains Voltage	100 VAC to 240 VAC, 50/60 Hz
AC Power Consumption	35 W typical at 40 °C (104 °F) ambient
Mains Connector	IEC 60320-C14 (inlet)
Power Dissipation	60 W (205 BTU, 52 kcal)
Physical	
Dimensions (H × W × D)	44 mm × 483 mm × 282 mm (1.7 in × 19.0 in × 11.1 in)
Net Weight	3.6 kg (7.3 lb)
Operating Temperature	0 °C to 40 °C (32 °F to 104 °F)
Cooling System	2 variable-speed fans, side venting
General	
PC Configuration Software	ControlSpace Designer
Network Control	Ethernet (RJ-45), 1 Gbps
RS-232/485 Ports	RS-232 (DTE) & Bose Professional CC-16 (RS-485 master); 3.81 mm, 3-pin Euroblock

EX-12AEC

Integrated DSP	
Signal Processor	32-bit fixed/floating-point DSP 456 MHz/Arm Cortex-A8 600 MHz
Maximum Calculation	3.6 GIPS / 2.7 GFLOPS
Delay	43 s
Sample Rate	48 kHz
Acoustic Echo Cancellation	
Tail Length	480 ms
Noise Reduction	32 dB
Latency	50 ms
Channels	12
References	4
Audio Over IP	
Dante	16 × 16, primary/secondary, routable to AEC
Indicators & Controls	
Display	256 × 64 OLED with rotary/push encoder
LED Status Indicators	Power/Status
Audio Signal Indication	On display
Electrical	
Mains Voltage	100 VAC to 240 VAC, 50/60 Hz
AC Power Consumption	35 W typical at 40 °C (104 °F) ambient
Mains Connector	IEC 60320-C14 (inlet)
Power Dissipation	60 W (205 BTU, 52 kcal)
Physical	
Dimensions (H × W × D)	44 mm × 483 mm × 282 mm (1.7 in × 19.0 in × 11.1 in)
Net Weight	2.4 kg (5.3 lb)
Operating Temperature	0 °C to 40 °C (32 °F to 104 °F)
Cooling System	2 variable-speed fans, side venting
General	
PC Configuration Software	ControlSpace Designer
Network Control	Ethernet (RJ-45), 1 Gbps

Telecom Compliance

FCC Compliance Statement

For United States Users

This equipment complies with Part 68 of the FCC rules and the requirements adopted by the ACTA. On the bottom side of this equipment is a label that contains, among other information, a product identifier in the format US:JUBBR01AEX-440C (for EX-440C) or US:JUBBR01AEX-1280C (for EX-1280C). If requested, this number must be provided to the telephone company. The information associated with the services the equipment is to be connected are REN: 0.1A, Jack type: RJ-11C.

The REN is useful to determine the number of devices that you may connect to your telephone line and still have all of those devices ring when your telephone number is called. In most, but not all areas, the sum of RENs of all devices connected to one line should not exceed five (5.0). To be certain of the number of devices that you may connect to your line, you may want to contact your local telephone company to determine the maximum REN for your calling area. For products approved after July 23, 2001, the REN for this product is part of the product identifier that has the format US:JUBBR01AEX-440C (for EX-440C) or US:JUBBR01AEX-1280C (for EX-1280C). The digits represented by 01A are the REN without a decimal point (e.g., 01A is a REN of 0.1A). For earlier products, the REN is separately shown on the label.

A plug and jack used to connect this equipment to the premises wiring and telephone network must comply with the applicable FCC Part 68 rules and requirements adopted by the ACTA. A compliant telephone cord and modular plug is provided with this product. It is designed to be connected to a compatible modular jack that is also compliant. See installation instructions for details.

This equipment may not be used on coin service provided by the telephone company. Connection to party lines is subject to state tariffs.

Should this equipment cause harm to the telephone network, the telephone company may discontinue your service temporarily. If possible they will notify you in advance that temporary discontinuance of service may be required. But if advance notice isn't practical, the telephone company will notify you as soon as possible. You will be informed of your right to file a complaint with the FCC. The telephone company may make changes in its facilities, equipment, operations or procedures that could affect the proper functioning of your equipment. If they do, you will be notified in advance to give you an opportunity to maintain uninterrupted telephone service.

This product is not intended to be repaired. If you experience trouble with this equipment, please contact:

Name: Bose Corporation
 Address: 100 The Mountain Rd., Framingham, MA, 01701 U.S.A.
 Telephone: (877) 428-2673

The telephone company may ask that you disconnect this equipment from the network until the problem has been corrected or until you are sure that the equipment is not malfunctioning.

According to the FCC's electrical safety advisory, we recommend that you may install an AC surge arrester in the AC outlet to which this equipment is connected. Telephone companies report that electrical surges, typically lightning transients, are very destructive to customer terminal equipment connected to AC power sources and that this is a major nationwide problem.

If your home has specially wired alarm equipment connected to the telephone line, ensure the installation of this equipment Model EX-440C or EX-1280C does not disable your alarm equipment. If you have questions about what will disable alarm equipment, consult your telephone company or a qualified installer.

For Canadian Users

This product meets the applicable Innovation, Science and Economic Development Canada technical specifications.

The Ringer Equivalence Number (REN) indicates the maximum number of devices allowed to be connected to a telephone interface. The termination of an interface may consist of any combination of devices subject only to the requirement that the sum of the RENs of all the devices not exceed five.

This Class A digital apparatus complies with Canadian ICES-003.

Pour les utilisateurs canadiens

Le présent matériel est conforme aux spécifications techniques applicables d'Industrie Canada.

L'indice d'équivalence de la sonnerie (IES) sert à indiquer le nombre maximal de terminaux qui peuvent être raccordés à une interface téléphonique. La terminaison d'une interface peut consister en une combinaison quelconque de dispositifs, à la seule condition que la somme d'indices d'équivalence de la sonnerie de tous les dispositifs n'excède pas 5.

Cet appareil numérique de la classe A est conforme à la norme NMB-003 du Canada.

For China RoHS Compliance:





788755-0030

©2023 Transom Post OpCo LLC. All rights reserved.
Framingham, MA 01701 USA
BoseProfessional.com
AM788755 Rev. 04
May 2023